

SAMSUNG

E-MANUAL

Thank you for purchasing this Samsung product.
To receive more complete service, please register your
product at

www.samsung.com

Model _____ Serial No. _____

To directly go to the page that provides instructions on
how to use the manual for visually impaired users, select
the Menu Learning Screen link below.

["Menu Learning Screen" Link](#)

Contents

Guide

Connections

- 5 Connection Guide
- 6 Connecting an Antenna (Aerial)
- 7 Connecting to the Internet
- 10 Screen Sharing (Smart View) with your Mobile Device
- 13 Connecting to a Network via a Mobile Dongle (For India Only)
- 14 Connection Cables for External Devices
- 16 ADB (Auto Data Backup) functions (For India Only)
- 17 Switching between external devices connected to the TV
- 19 Connection Notes

Remote Control and Peripherals

- 22 About the Samsung Smart Remote
- 25 About the Samsung Smart Remote (The Frame)
- 28 About the Samsung Smart Remote (The Sero)
- 31 Connecting the Samsung Smart Remote to the TV
- 32 Controlling External Devices with a Samsung Remote Control - Using the Universal Remote
- 33 Using Anynet+ (HDMI-CEC)
- 34 Controlling the TV with a Keyboard, Mouse or Gamepad
- 36 Entering Text using the On-Screen Virtual Keyboard

Smart Features

- 38 Using Smart Hub
- 47 Using a Samsung account
- 49 Using the Ambient Mode
- 53 Using Remote Access
- 58 Using the Apps Service
- 62 Using the Gallery App
- 63 Using the SmartThings App
- 64 Using the e-Manual
- 67 Using the Internet

- 68 Playing pictures/video/music

- 75 Using Bixby

TV Viewing

- 79 Using the Guide
- 81 Recording Programmes
- 83 Setting Up a Schedule Viewing
- 85 Using Timeshift
- 85 Buttons and functions available while recording a programme or Timeshift
- 87 Using the Channel List
- 88 Editing channels
- 89 Using a Personal Favourites List
- 90 TV-Viewing Support Functions

Picture and Sound

- 97 Using the Intelligent Mode
- 99 Adjusting the Picture Quality
- 101 Setting the Viewing Environment for External Devices
- 103 Picture Support Functions
- 104 Configuring a Sound Mode and Expert Settings
- 106 Using the Sound Support Functions

System and Support

- 108 Using the Time Functions and the Timers
- 110 Using the Auto Protection Time and Energy Saving Functions
- 111 Updating the TV's Software
- 112 Audio and Video Functions for the Visually or Hearing Impaired
- 117 Using Voice Assistants on TV
- 118 Using Other Functions
- 120 HbbTV
- 121 Using a TV Viewing Card ("CI or CI+ Card") (For India Only)
- 124 Teletext Feature

Precautions and Notes

128	Before Using the Recording and Timeshift Functions
130	Read Before Using Apps
131	Read Before Using the Internet Function
133	Read Before Playing Photo, Video or Music Files
141	Read After Installing the TV
142	Supported Resolutions for UHD Input Signals
143	Resolutions for Input Signals supported by Q800T series or higher
144	Supported Resolutions for FreeSync(VRR)
145	Read Before Connecting a Computer (Supported Resolutions)
148	Supported Resolutions for Video Signals
150	Supported Resolutions for HDBT
151	Read Before Using Bluetooth Devices
152	Suffix : Parental Rating - Thailand only
153	Licences

Troubleshooting

Picture Issues

154 Testing the picture

Sound and Noise Issues

158 Testing the sound

Channel and Broadcast Issues

External Device Connectivity Issues

Network Issues

Anynet+ (HDMI-CEC) Issues

Remote Control Issues

Recording Issues

Apps

Media Files

Voice Assistant Issues

Other issues

Diagnosing TV operational issues

Getting Support

174 Getting support through Remote Management

174 Finding the contact information for service

174 Requesting service

FAQ

The TV Screen does not Display Properly

175 When the TV screen does not display properly

The TV does not Turn On

182 When your TV does not turn on

The TV Screen Breaks Up or No Sound Comes Out of the Sound Bar

188 When the TV does not connect with an external device properly

Internet Access is not Available

193 When the TV can't connect to the Internet

There is No Sound or the Speakers are Making Odd Sound

198 When no sound comes out of the TV, or the sound is breaking up

The Remote Control does not Work

205 When the remote control does not work

Updating the Software

210 Updating the latest TV's software

Accessibility Guidance

Menu Learning Screen

217 Using the Remote control

219 Using the accessibility menu

223 Using the TV with Voice Guide on

225 Using the guide

228 Using Schedule Viewing

229 Using the Channel List

231 Recording

234 Using Smart Hub

237 Launching the e-Manual

238 Using Bixby

Guide

Learn how to use various features.

Connections

You can watch live broadcasts by connecting an antenna cable to your TV and can get access to the Internet by using a LAN cable or wireless access point. Using various connectors, you can also connect external devices.

Connection Guide

You can view detailed information about external devices that can be connected to the TV.

 >  [Source](#) > [Connection Guide](#) [Try Now](#)

It shows you how to connect various external devices such as video devices, game consoles and PCs using pictures. If you select the connection method and an external device, the connection details appear.

- [Audio Device: HDMI \(ARC\), Optical, Bluetooth, Wi-Fi, Wi-Fi Speaker Surround Setup](#)

 [HDMI \(ARC\)](#) is supported by some models. Check the HDMI port name of the purchased product's model.

- [Video Device: HDMI](#)
- [Smartphone: Screen Sharing \(Smart View\), SmartThings, Apple AirPlay, NFC on TV, Tap View](#)
- [PC: HDMI, Screen Sharing \(Wireless\), Apple AirPlay](#)
- [Input Device: Remote control, Keyboard, Mouse, USB Gamepad, Bluetooth Device](#)
- [Game Console: HDMI](#)
- [External Storage: USB Flash Drive, Hard Disk Drive \(HDD\)](#)

 Using [HDMI Troubleshooting](#), you can check the connection to HDMI cable and external devices (takes approximately 2 minutes).

 Apple AirPlay may not be supported depending on the model or geographical area.

 The connection method and available external devices may differ depending on the model.

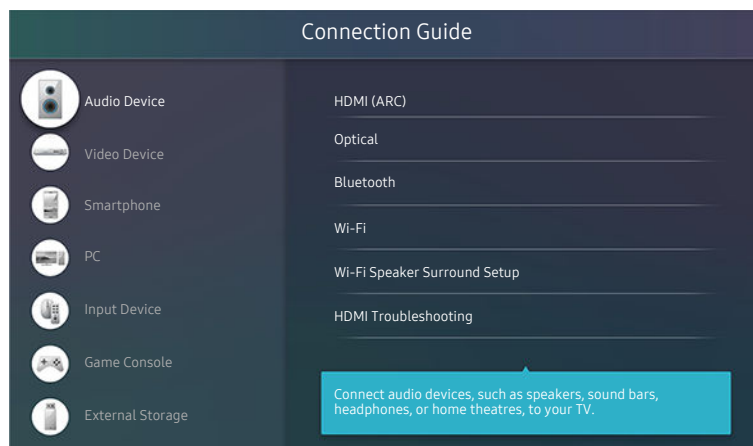

 The image on your TV may differ from the image above depending on the model and geographical area.

Connecting an Antenna (Aerial)

You can connect an antenna cable to your TV.

 An antenna connection is not necessary if you connect a cable box or satellite box.

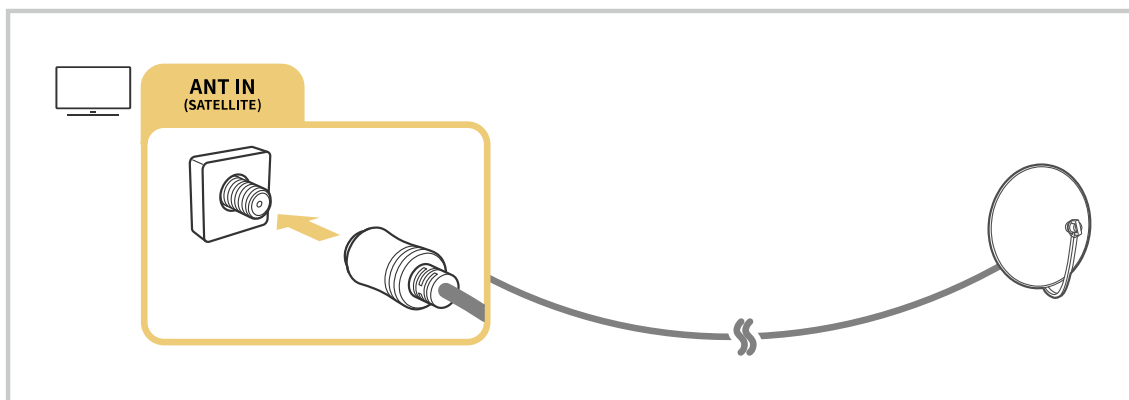
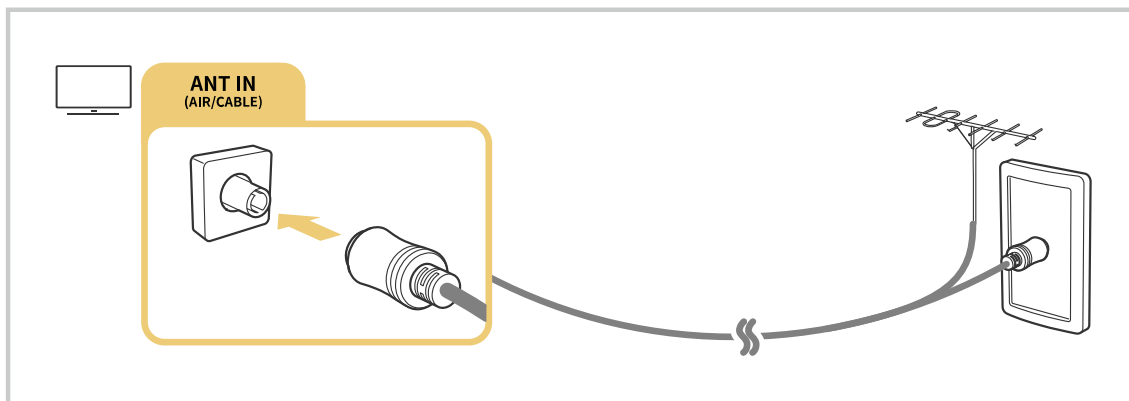

 Depending on the model or geographical area.

Connecting to the Internet

You can get access to the Internet through your TV.

 >  **Settings** > **General** > **Network** > **Open Network Settings** [Try Now](#)





Configure network settings to connect to an available network.

Establishing a wired Internet connection

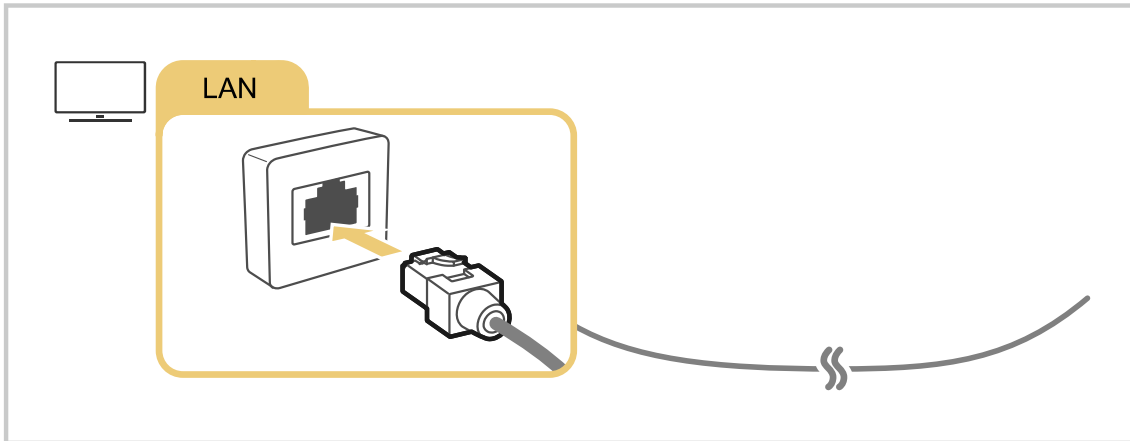
 >  **Settings** > **General** > **Network** > **Open Network Settings** > **Wired**

If you connect a LAN cable, the TV automatically accesses the Internet.



-  If the TV does not automatically connect to the network, refer to "[Network Issues](#)" in "Troubleshooting".
-  Use a CAT 7 (*STP type) cable for the connection.
 - * Shielded Twisted Pair
-  The TV will not be able to connect to the Internet if your network speed is below 10 Mbps.
-  This function may not be supported depending on the model.

Establishing a wireless Internet connection

🏠 > ⚙️ **Settings** > **General** > **Network** > **Open Network Settings** > **Wireless**

Make sure that you have the wireless access point's SSID (name) and password settings before attempting to connect. The network name (SSID) and security key are available on the wireless access point's configuration screen. See the wireless access point's user manual for more information.

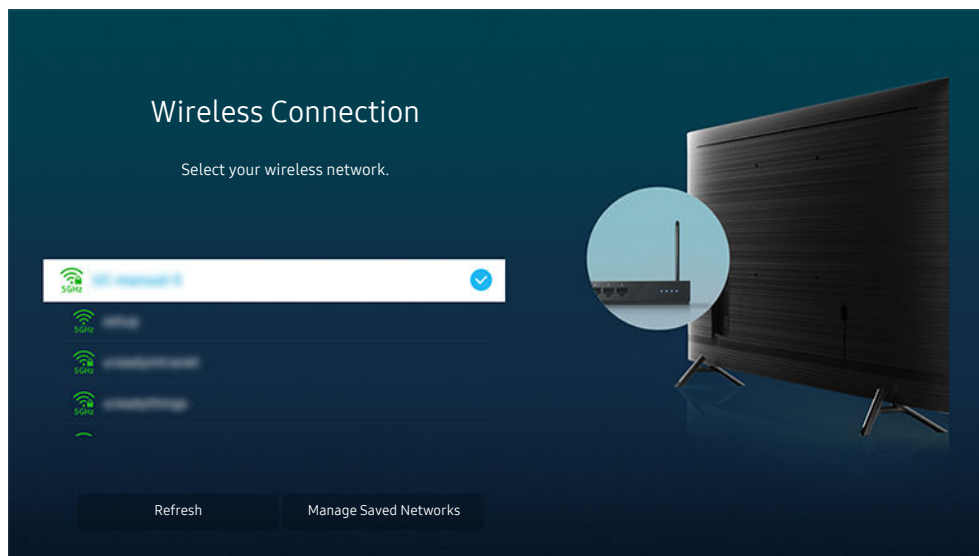
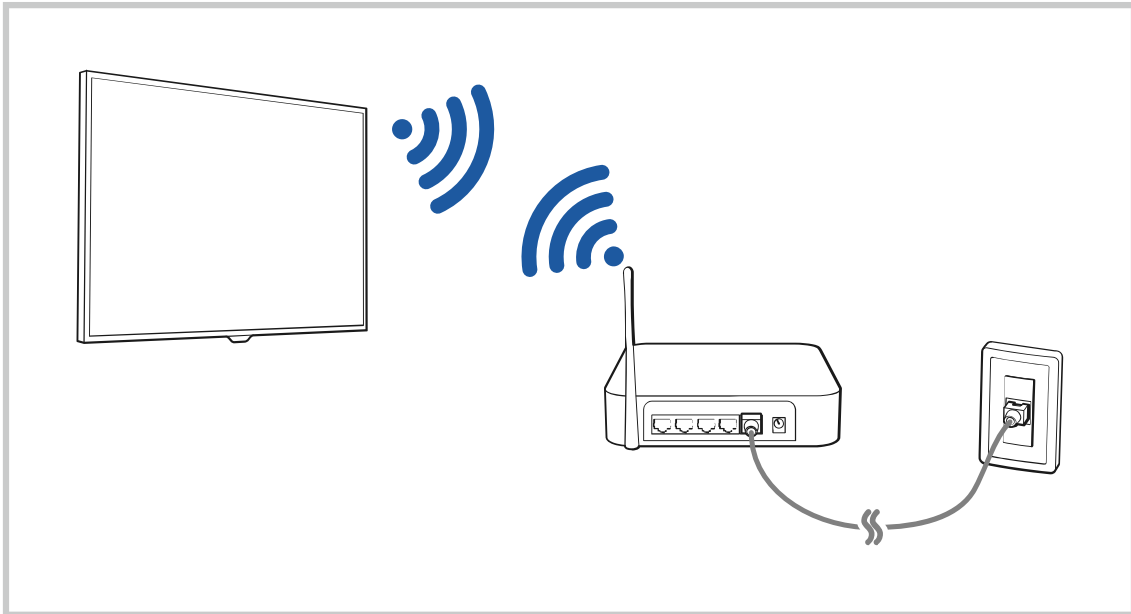

- ✎ The image on your TV may differ from the image above depending on the model and geographical area.
- ✎ If no wireless access point is found, select **Add Network** at the bottom of the list and enter the network name (SSID).
- ✎ If your wireless access point has a WPS or PBC button, select **Use WPS** at the bottom of the list, and then push the WPS or PBC button on your access point within 2 minutes. The TV will connect automatically.
- ✎ To view or delete previously connected network names (SSIDs), move the focus to **Manage Saved Networks**, and then press the Select button.

Checking the Internet connection status

 >  [Settings](#) > [General](#) > [Network](#) > [Network Status](#) [Try Now](#)

View the current network and Internet status.

Resetting Your Network

 >  [Settings](#) > [General](#) > [Network](#) > [Reset Network](#) [Try Now](#)

Restore the network settings to the factory default.

Turning on the TV with a mobile device

 >  [Settings](#) > [General](#) > [Network](#) > [Expert Settings](#) > [Power On with Mobile](#)

You can turn on the TV using a mobile device connected to the same network as the TV.

 This function is available with a mobile device connected to the TV through the SmartThings app or the Apple AirPlay function.

 Apple AirPlay may not be supported depending on the model or geographical area.

Connecting an IP control device to the TV

 >  [Settings](#) > [General](#) > [Network](#) > [Expert Settings](#) > [IP Remote](#)

You can connect an IP control device to the TV remotely to manage your IP device.

 To use this function, [Power On with Mobile](#) must be turned on.

 Turning this feature on may allow other IP control devices to control your TV. We recommend turning this feature on only if an authorised third-party custom controller is installed and configured specifically for a Samsung TV and if your Wi-Fi network is password protected.

 This function may not be supported depending on the model or geographical area.



Changing the name of the TV

 >  [Settings](#) > [General](#) > [System Manager](#) > [Device Name](#) [Try Now](#)



You can change the name of the TV on the network. Select [User Input](#) at the bottom of the list and change the name.

Screen Sharing (Smart View) with your Mobile Device

You can watch the screen of your mobile device on the TV screen through Smart View or Tap View.

For information on how to share the screen with your mobile device, refer to  >  [Source](#) > [Connection Guide](#) > [Smartphone](#) > [Screen Sharing \(Smart View\)](#).

 For more information in The Terrace for business, refer to the provided user manual.

- To turn off Screen Sharing (Smart View), disconnect the mobile device or press the  button on the remote control.
- Using the Smart View menu on your mobile device, you can change the settings such as aspect ratio.
- Use AirPlay if you are an iPhone or iPad user. For more information, refer to  >  [Source](#) > [Connection Guide](#) > [Smartphone](#) > [Apple AirPlay](#)

 This function may not be supported depending on the model.

- The screen sharing function ([Smart View](#) / [Apple AirPlay](#)) on your mobile device appears on Multi View of the TV (or the screen on your mobile device).

 Apple AirPlay may not be supported depending on the model or geographical area.

Using the Tap View

Tap your mobile device on the TV, you can watch the **Multi View** or mobile device's screen through the TV screen.

 This function may not be supported depending on the model.

 This function is available in Samsung mobile devices with Android 8.1 or higher.

1. Enable **Tap View** on your mobile device.

 For more information about configuration, refer to 'Enabling the Tap View' below for how to set.

2. Turn on the screen of your mobile device.
3. Tap your mobile device on the TV. The TV screen switches to **Multi View** or mobile device's screen.

 When you perform Tap View in **Ambient Mode** feature or **Art** mode (only in The Frame models), only the mobile device's screen appears on the TV.

4. Watch the **Multi View** or mobile device's screen on the TV screen.

 The displayed TV screen may differ depending on the model.

 This function enables mirroring (Smart View) by detecting vibrations generated when you tap the mobile device on the TV.

 Be sure to tap away from the TV screen and bezel corners. It may be scratched or broken to the TV or mobile device screen.

 We recommend using your mobile device with the cover in place and lightly tap it on any external edge of the TV.

Enabling the Tap View

Enable **Tap View** in the SmartThings app.

 Depending on the SmartThings app version, you may need to register the TV with your mobile device.











1. Launch the SmartThings app on your mobile device.
2. Select Settings (☰ > ⚙️) in SmartThings app on your mobile device.
3. Set the **Tap View** to on.

 Upon connection for the first time, select Allow on a pop-up window of the TV.

Using the Multi View

While watching the TV, you can see content from your mobile device through mirroring (Smart View).

To start **Multi View**, run the screen sharing (**Smart View / Apple AirPlay**) for your mobile device. This function can be started or stopped by pressing the  button on the remote control.

-  This function operates only by TV broadcasts, external devices, or apps that support **Multi View**.
-  While running **Multi View**, app casting from your mobile device is run on **Multi View**. This function is not available in some apps.
-  To stop this function, press and hold the  button on the remote control.
-  This function may not be supported depending on the model.
-  In some models, you can view the image on the camera connected to the SmartThings app of your mobile device.
-  Q-Symphony is not supported by Multi View.
-  When an external device that connects to a receiver or Soundbar is used in Multi View, sound outputs from the TV speaker, not from the receiver or Soundbar.
-  The following menus can be set by pressing the down directional button on the TV's remote control.
-  When you press the Select button while running **Multi View**, the focused screen is viewed in the full screen.

- **Select Content**

Selects content to be displayed on the left screen.

-  Press the down directional button on the TV screen. Available content items appear.

- **Watch Mobile/Camera**

Enjoy your mobile content by mirroring (Smart View).

You can view the camera video connected to the SmartThings app on your mobile.

- **Screen Size**

Selects the desired size of **Multi View**.

- **PIP Position**

Selects the position of a small screen on the full screen.

The focusing left or right screen appears as small window.

- **Sound Output**

You will hear the sound of the selected screen through another speaker connected to the TV.

-  This function may not be supported depending on the model.

- **Sound Distribution**





You will hear the sound of both screens at the same time by adjusting the ratio of each screens sound.

-  This function may not be supported depending on the model.

Connecting to a Network via a Mobile Dongle (For India Only)

Make network connection by connecting a mobile dongle to the TV.

You can make the TV to connect to a network via a mobile device by connecting a mobile dongle to the TV. Connect the mobile dongle to the USB port that are marked as Dongle in the TV.

-  This function is not available on certain models in specific geographical areas.
-  When you use a large mobile dongle(Data Card), USB devices may not work properly due to interferences among the USB ports, or the wireless network may not work properly due to interferences from the peripherals and surroundings. In this case, use a USB extension cable to connect a large mobile dongle to a USB port.
-  **Channel-Bound Apps** is not available when you set up mobile network.
-  If you have any problems using online services, please contact your Internet service provider.

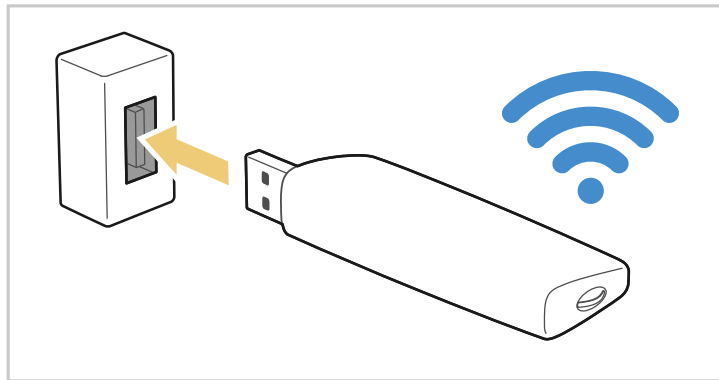





The mobile service providers and their devices that support this function are as follows:

- Airtel (Model No: E3276s LTE, E1731, E303C, E303U, E3131B, E3121B, E8221, E8231, E3276 LTE)
- Idea, Vodafone

Connection Cables for External Devices

You can view detailed information about the connection cables for external devices that can be connected to the TV.

Cable name	Image	Description
HDMI to HDMI		<p>Each cable simultaneously transmits digital video and audio signals from an external device to the HDMI port on the TV.</p> <p>Cables are divided into various types according to the types of input/output ports on external devices.</p>
HDMI to MINI HDMI		
HDMI to Micro HDMI		
HDMI to USB Type-C		
HDMI to DisplayPort		
Mini DisplayPort to HDMI		

Cable name	Image	Description
DVI to HDMI		<p>DVI to HDMI cables can transmit only digital video signals and not audio signals. We recommend that you use HDMI to HDMI cables.</p>
Optical		<p>Optical cables are used to transmit audio signals to external speakers with low signal loss.</p> <p>Optical cables do not transmit video signals.</p>
Component		<p>Component cables transmit analogue signals.</p> <p>The video signal is separated and transmitted to the red, green and blue terminals to provide HD (1080i) pictures. The audio signal is transmitted to the red and white terminals.</p>
Composite		<p>Composite cables transmit analogue signals.</p> <p>The video signal is transmitted to the yellow terminal and the audio signal is transmitted to the red and white terminals.</p>

 Available connection cables may differ depending on the model or geographical area.

ADB (Auto Data Backup) functions (For India Only)

 This function may not be supported depending on the model or geographical area.

Your mobile device comes close to the TV, the ADB (Auto Data Backup) feature backs up your mobile data such as images and videos into a pre-configured specific folder on a USB storage device or an external hard disk drive connected to the TV. You can also transfer files from the ADB (Auto Data Backup) folder to a Samsung mobile device over Wi-Fi Direct.

- Transferring data from a mobile device to the TV

Your mobile device comes close to the TV, images and videos are copied from your mobile device to a USB storage device or an external hard disk drive connected to the TV.

- Transferring data from the TV to a mobile device

You can select and transfer files from the ADB (Auto Data Backup) folder on the TV to a Samsung mobile device.

How to Use ADB (Auto Data Backup)

1 ADB (Auto Data Backup) Registration

First, register the TV using the USB Backup app, and then select a USB storage device or an external hard disk drive connected to the TV. The ADB (Auto Data Backup) folder is automatically created on the selected storage device. Then, select folders from your mobile device's gallery, set the password to open the ADB (Auto Data Backup) folder on the selected storage device connected to the TV.

2 Auto File Copy

When your mobile device comes close to the TV, data are automatically copied from the selected folders on your mobile device to the selected storage device connected to the TV.

3 Share files back from the ADB folder to a mobile device

You can also share file back from ADB folder to Samsung Mobile, by first connecting Samsung Mobile with TV over Wi-Fi direct & then select the files to be transferred from TV, and press "Share" option to send files to connected Mobile device.

Switching between external devices connected to the TV

You can switch between TV programmes and the content of external devices.

🏠 > 📺 Source

When you select a connected external device on the **Source** screen, the output of the selected device is displayed on the TV's screen.

- ✎ On the standard remote control, press the SOURCE button.
- ✎ To control a device (Blu-ray player, game console, etc.) that supports universal remote control with the TV's remote control, connect the device to an HDMI port on the TV, and then turn on the device. The output displayed on the TV is automatically switched to the output of the device or you can configure universal remote control for the device automatically. For more information, refer to "Controlling External Devices with a Samsung Remote Control - Using the Universal Remote".
- ✎ When a USB device is connected to the USB port, a pop-up message appears that lets you switch easily to the media content listed on the device.
- ✎ This function may not be supported depending on the device and geographical area.

Editing the name and icon of an external device

🏠 > 📺 Source

You can change the port name for a connected external device or add it to the Home Screen.

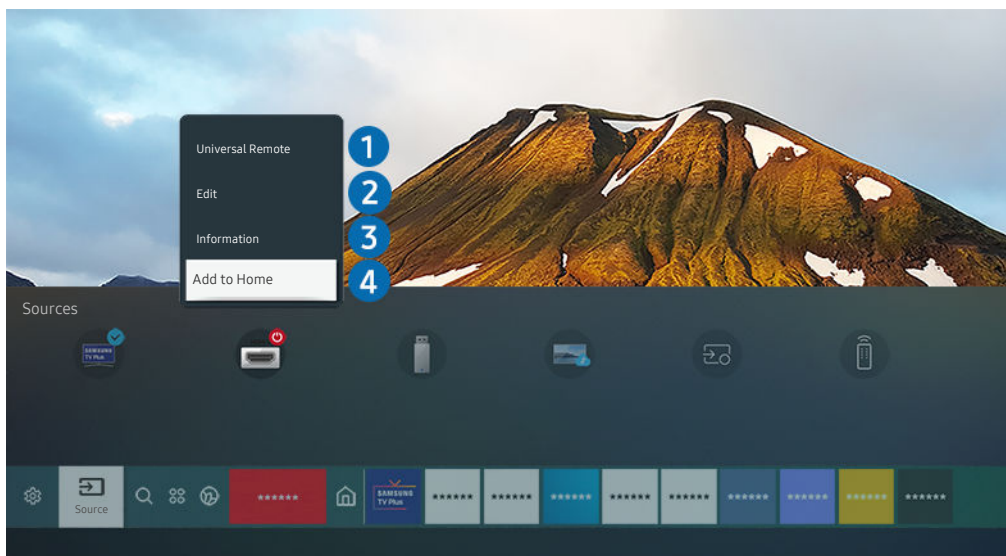

✎ The image on your TV may differ from the image above depending on the model and geographical area.

1. Move the focus to a connected external device.
2. Press the up directional button. The following functions become available.

✎ Available functions may differ depending on the port type.

1 Universal Remote

You can control external devices connected to the TV using a Samsung remote control. To control external devices, register them by following the instructions on the screen.

 This function may not be supported depending on the model or geographical area.

 For more information, refer to "[Controlling External Devices with a Samsung Remote Control - Using the Universal Remote](#)".

2 Edit

You can rename the input ports and change the device icons.

3 Information

You can view detailed information about an external device.

4 Add to Home

You can add the port of an external device to the Home Screen for quick switching.

Using additional functions

You can use the following features on the [Source](#) screen.

- [Remote Access](#)

Use the TV to access your PC via remote PC or Screen Sharing (Wireless).

 For more information, refer to "[Using Remote Access](#)".

- [Connection Guide](#)

Displays device connection instructions.

 For more information about the [Connection Guide](#), refer to "[Connection Guide](#)".

- [Universal Remote](#)



Lets you register external devices to your Samsung remote control and control them using the Remote.

 This function may not be supported depending on the model or geographical area.

 For more information, refer to "[Controlling External Devices with a Samsung Remote Control - Using the Universal Remote](#)".

Connection Notes

When connecting an external device, note the following.

-  The number of connectors and their names and locations may differ with the model.
-  Refer to the external device's operating manual when connecting it to the TV. The number of external device connectors and their names and locations may differ with the manufacturer.

Connection notes for HDMI

- The following types of HDMI cables are recommended:
 - High Speed HDMI Cable
 - High Speed HDMI Cable with Ethernet
 - Premium High Speed HDMI Cable
 - Premium High Speed HDMI Cable with Ethernet
 - Ultra High Speed HDMI Cable
- Use an HDMI cable with a thickness of 17 mm or less.
- Using a non-certified HDMI cable may result in a blank screen or a connection error.
- Some HDMI cables and devices may not be compatible with the TV due to different HDMI specifications.
- This TV does not support HDMI Ethernet Channel. Ethernet is a Local Area Network (LAN) built with coaxial cables standardised by the IEEE.
- Use a cable shorter than 3 m to get the best UHD viewing quality.
- Many computer graphics adaptors do not have HDMI ports, but have DVI or DisplayPort ports instead. If your PC does not support HDMI video out, connect your PC with a DVI to HDMI or HDMI to DisplayPort cable.
- When the TV is connected to an external device such as a DVD/BD player or a set-top box via HDMI, power sync mode will be automatically activated. In the power sync mode, the TV continues to detect and connect external devices via HDMI cable. This function can be deactivated by removing the HDMI cable of the connected device.
 -  This function may not be supported depending on the model.



Connection notes for audio devices

- For better audio quality, it is a good idea to use an AV receiver.
- If you connect an external audio device using an optical cable, the **Sound Output** setting is automatically changed to the connected device. However, to make this happen, you must turn on the external audio device before connecting the optical cable. To manually change the **Sound Output** setting, do one of the following:
 - Use the **Quick Settings** screen to change to the connected device:
Use the Select button to select **Optical** on the **Sound Output** menu. (🏠 > ⚙️ **Settings** > up directional button > **Sound Output**).
 - Use the **Settings** screen to change to the connected device:
Select **Optical** on the **Sound Output** menu. (🏠 > ⚙️ **Settings** > **Sound** > **Sound Output**).
-  Refer to the sound bar's user manual when connecting it to the TV.
- An unusual noise coming from a connected audio device while you are using it may indicate a problem with the audio device itself. If this occurs, ask for assistance from the audio device's manufacturer.
- Digital audio is only available with 5.1 channel broadcasts.

Connection notes for computers

- For the resolutions supported by the TV, refer to "[Read Before Connecting a Computer \(Supported Resolutions\)](#)".
- If you want to connect your PC and TV wirelessly, both of them must be connected to each other on the same network.
- When sharing content with other network-based devices such as those in an IP (Internet Protocol) storage system, sharing may not be supported due to the network's configuration, quality or functionality, for example, if the network has an NAS (Network-Attached Storage) device.

Connection notes for mobile devices

- To use the Smart View function, the mobile device must support a mirroring function such as Screen Mirroring or Smart View. To check whether your mobile device supports the mirroring function, refer to the mobile device's user manual.
- To use Wi-Fi Direct, the mobile device must support the Wi-Fi Direct function. To check whether your mobile device supports Wi-Fi Direct function, refer to the mobile device's user manual.
- The mobile device and your Smart TV must be connected to each other on the same network.
- Use AirPlay if you are an iPhone or iPad user. For more information, refer to  >  [Source](#) > [Connection Guide](#) > [Smartphone](#) > [Apple AirPlay](#)

 This function may not be supported depending on the model.

- The video or audio may stop intermittently, depending on network conditions.
- When sharing content with other network-based devices such as those in an IP (Internet Protocol) storage system, sharing may not be supported due to the network's configuration, quality or functionality, for example, if the network has an NAS (Network-Attached Storage) device.









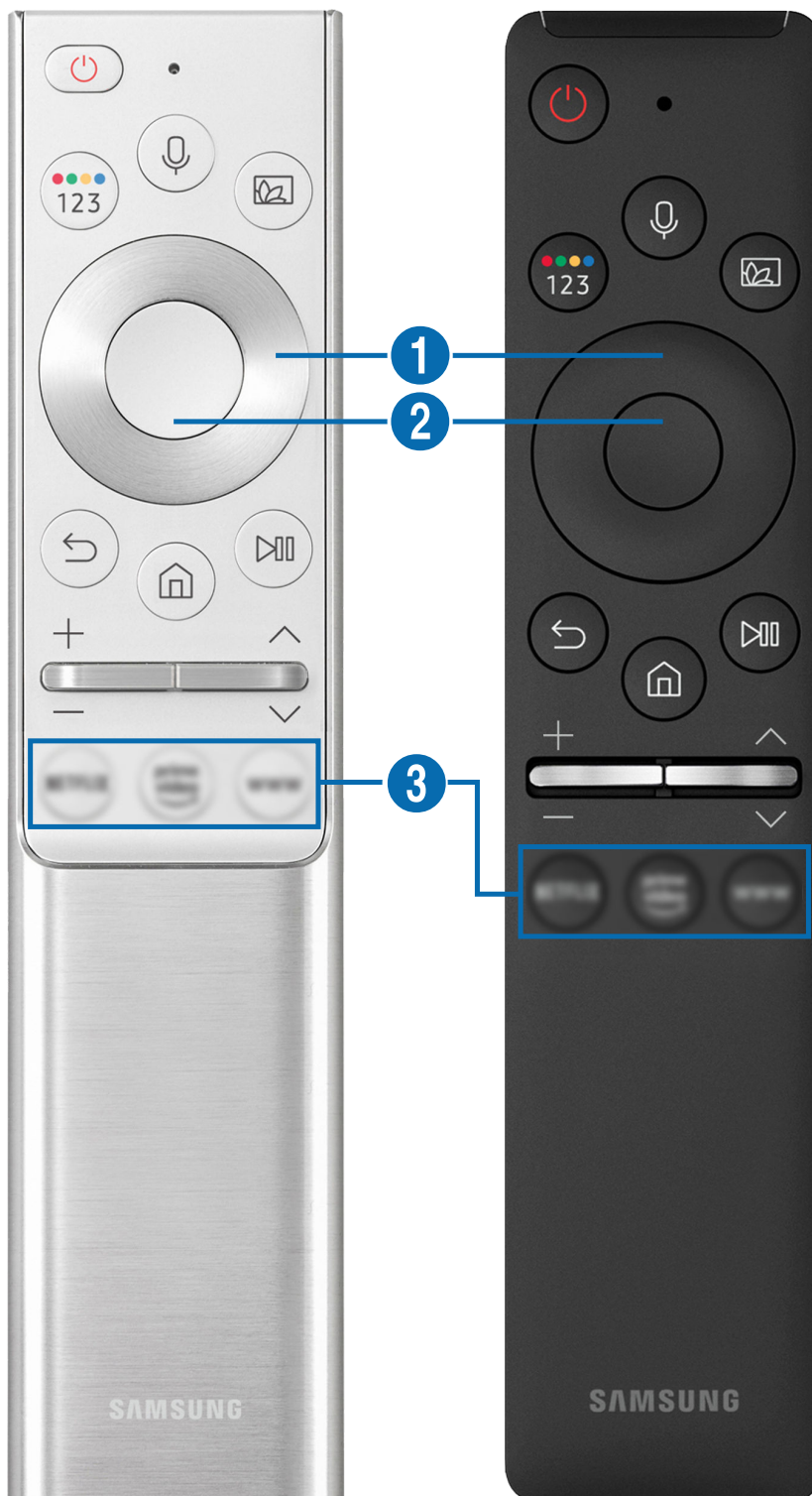

Remote Control and Peripherals



You can control TV operations with your Samsung Smart Remote. Pair external devices such as a keyboard for ease of use.





About the Samsung Smart Remote

Learn about the buttons on the Samsung Smart Remote.



Button	Description
 (Voice Assistant)	<p>Runs Voice Assistant. Press and hold the button, say a command, and then release the button to run Voice Assistant.</p> <p> The supported Voice Assistant's languages and features may differ by geographical region.</p>
 (Colour / Number button)	<p>Each time you press this button, the coloured buttons window and the virtual numeric pad are displayed alternately.</p> <ul style="list-style-type: none"> • Use this button to access additional options that are specific to the feature in use. • Press to bring up the virtual numeric pad on the screen. Use the numeric keypad to enter numeric values. Select numbers and then select Done to enter a numeric value. Use to change the channel, enter a PIN, enter a ZIP code, etc. <p> When you press the  button, and then select TTX/MIX from the pop-up list, the TTX menu appears. For more information, refer to "Teletext Feature".</p> <p> If the Colour Button appears with a number strip on the screen, select the Colour Button and then select a specific colour by using the directional button (up/down/left/right). Use this to access additional options that are specific to the feature in use.</p>
 (Ambient Mode)	<p>In TV mode, press the button to enter Ambient Mode.</p> <p>If you press the button when the TV is turned off, the TV turns on in Ambient Mode.</p>
 Directional button (up/down/left/right)	<p>Moves the focus.</p>
 Select	<p>Selects or runs a focused item. When pressed while you are watching a broadcast programme, detailed programme information appears.</p>
 (Return)	<p>Press to return to the previous menu. When pressed for 1 second or more, the running function is terminated. When pressed while you are watching a programme, the previous channel appears.</p>
 (Smart Hub)	<p>Press to return to the Home Screen.</p>









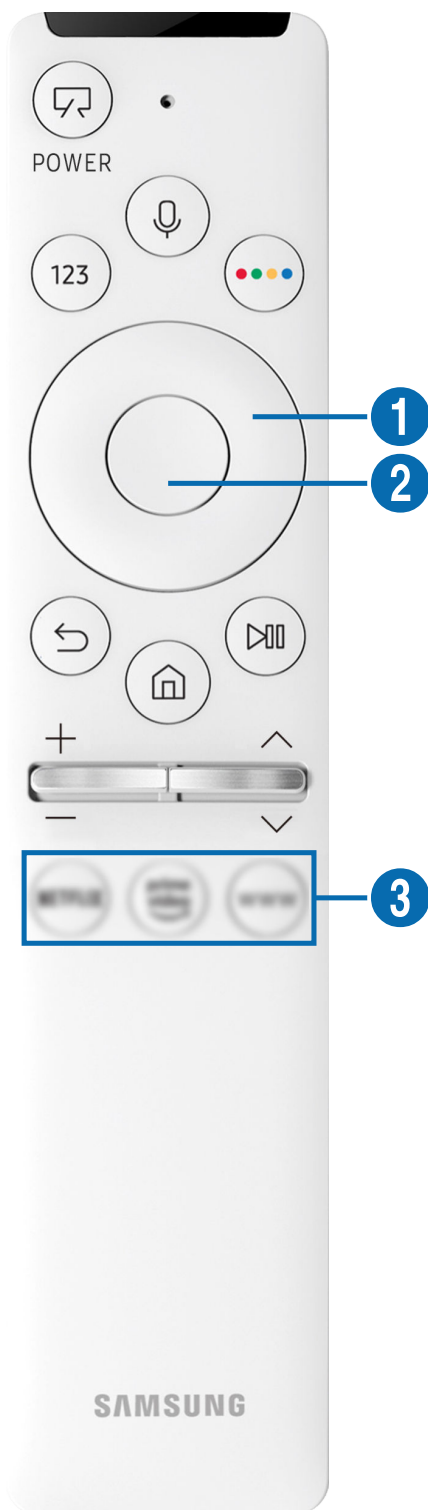



Button	Description
 (Play/pause)	<p>When pressed, the playback controls appear. Using these controls, you can control the media content that is playing.</p> <p>Press the button to use the recording or Timeshift function while watching the broadcast.</p>
+/- (Volume)	Move the button up or down to adjust the volume. To mute the sound, press the button. When pressed for 1 second or more, the Accessibility Shortcuts appears.
^/∨ (Channel)	<p>Move the button up or down to change the channel. To see the Guide or Channel List screen, press the button.</p> <p>Press and hold the button up or down to quickly change the channel.</p>
 (Launch app button)	<p>Launch the app indicated by the button.</p> <p> This function may not be supported depending on the model or geographical area.</p>



-  Use the Samsung Smart Remote less than 6 m from the TV. The usable distance may vary with the wireless environmental conditions.
-  The images, buttons and functions of the Samsung Smart Remote may differ with the model or geographical area.
-  To use the Samsung Smart Remote to control a compatible external device that does not support HDMI-CEC (Anynet+), you must configure universal remote control for the device. For more information, refer to "[Controlling External Devices with a Samsung Remote Control - Using the Universal Remote](#)".
-  To use the Samsung Smart Remote to control a compatible external device that does support HDMI-CEC (Anynet+), connect the device to an HDMI port on the TV using an HDMI cable. For more information, refer to "[Using Anynet+ \(HDMI-CEC\)](#)".





About the Samsung Smart Remote (The Frame)

Learn about the buttons on the Samsung Smart Remote that comes with The Frame.



Button	Description
 (Power)	<p>When watching TV, press to switch to Art mode. In Art mode, press to switch to watching TV.</p> <p>Press and hold to turn off the TV completely.</p> <p> When the TV turns off and on again, display the last used mode.</p>
 (Voice Assistant)	<p>Runs Voice Assistant. Press and hold the button, say a command, and then release the button to run Voice Assistant.</p> <p> The supported Voice Assistant's languages and features may differ by geographical region.</p>
 (Number button)	<p>Press to bring up the virtual numeric pad on the screen. Use the numeric keypad to enter numeric values.</p> <p>Select numbers and then select Done to enter a numeric value. Use to change the channel, enter a PIN, enter a ZIP code, etc.</p> <p> When you press the  button, and then select TTX/MIX from the pop-up list, the TTX menu appears. For more information, refer to "Teletext Feature".</p>
 (Colour button)	<p>When pressed, coloured buttons appear on the screen. Use this button to access additional options that are specific to the feature in use.</p> <p> To immediately set Brightness while enjoying Art mode, press the button.</p>
 Directional button (up/down/left/right)	<p>Moves the focus.</p>
 Select	<p>Selects or runs a focused item. When pressed while you are watching a broadcast programme, detailed programme information appears.</p>
 (Return)	<p>Press to return to the previous menu. When pressed for 1 second or more, the running function is terminated. When pressed while you are watching a programme, the previous channel appears.</p>
 (Smart Hub)	<p>Press to return to the Home Screen.</p> <p>Press in Art mode to switch to TV mode.</p>









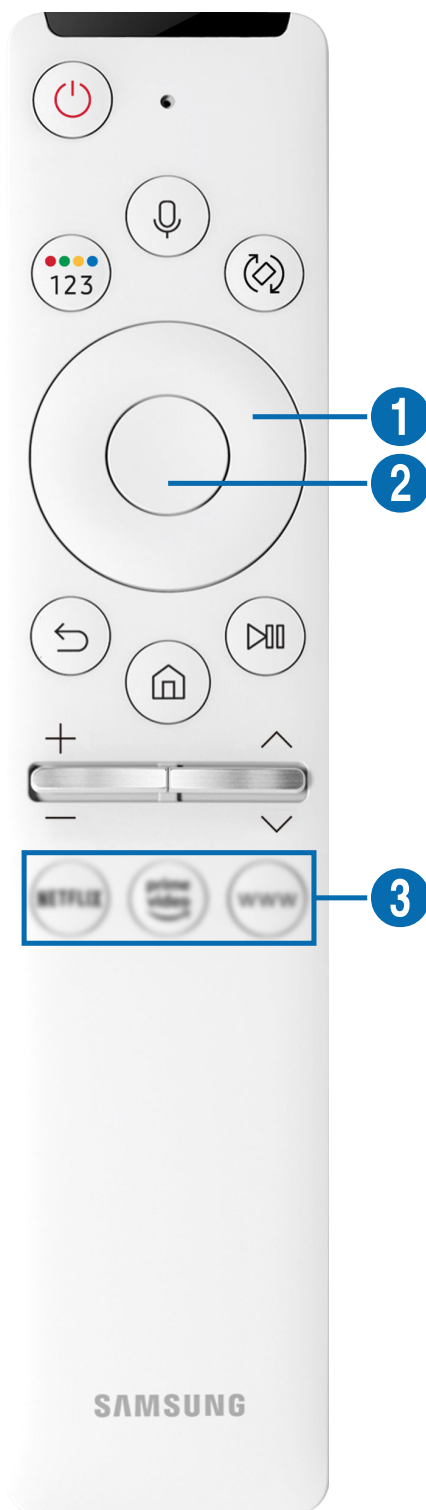

Button	Description
 (Play/pause)	<p>When pressed, the playback controls appear. Using these controls, you can control the media content that is playing.</p> <p>Press the button to use the recording or Timeshift function while watching the broadcast.</p>
+/- (Volume)	<p>Move the button up or down to adjust the volume. To mute the sound, press the button. When pressed for 1 second or more, the Accessibility Shortcuts appears.</p>
^/∨ (Channel)	<p>Move the button up or down to change the channel. To see the Guide screen, press the button. When pressed for 1 second or more, the Channel List screen appears.</p> <p>Press and hold the button up or down to quickly change the channel.</p>
 (Launch app button)	<p>Launch the app indicated by the button.</p> <p> This function may not be supported depending on the model or geographical area.</p>





-  Use the Samsung Smart Remote less than 6 m from the TV. The usable distance may vary with the wireless environmental conditions.
-  The images, buttons and functions of the Samsung Smart Remote may differ with the model or geographical area.
-  To use the Samsung Smart Remote to control a compatible external device that does not support HDMI-CEC (Anynet+), you must configure universal remote control for the device. For more information, refer to "[Controlling External Devices with a Samsung Remote Control - Using the Universal Remote](#)".
-  To use the Samsung Smart Remote to control a compatible external device that does support HDMI-CEC (Anynet+), connect the device to an HDMI port on the TV using an HDMI cable. For more information, refer to "[Using Anynet+ \(HDMI-CEC\)](#)".





About the Samsung Smart Remote (The Sero)

Learn about the buttons on the Samsung Smart Remote that comes with The Sero.





Button	Description
 (Voice Assistant)	<p>Runs Voice Assistant. Press and hold the button, say a command, and then release the button to run Voice Assistant.</p> <p> The supported Voice Assistant's languages and features may differ by geographical region.</p>
 (Colour / Number button)	<p>Each time you press this button, the coloured buttons window and the virtual numeric pad are displayed alternately.</p> <ul style="list-style-type: none"> • Use this button to access additional options that are specific to the feature in use. • Press to bring up the virtual numeric pad on the screen. Use the numeric keypad to enter numeric values. Select numbers and then select Done to enter a numeric value. Use to change the channel, enter a PIN, enter a ZIP code, etc. <p> When you press the  button, and then select TTX/MIX from the pop-up list, the TTX menu appears. For more information, refer to "Teletext Feature".</p> <p> If the Colour Button appears with a number strip on the screen, select the Colour Button and then select a specific colour by using the directional button (up/down/left/right). Use this to access additional options that are specific to the feature in use.</p>
 (Rotate)	<p>Press the button to rotate the screen.</p>
 1 Directional button (up/down/left/right)	<p>Moves the focus.</p>
 2 Select	<p>Selects or runs a focused item. When pressed while you are watching a broadcast programme, detailed programme information appears.</p>
 (Return)	<p>Press to return to the previous menu. When pressed for 1 second or more, the running function is terminated. When pressed while you are watching a programme, the previous channel appears.</p> <p>When pressed for over 1 second in Portrait Mode, the content screen only for Portrait Mode appears.</p>
 (Smart Hub)	<p>Press to return to the Home Screen.</p>

Button	Description
 (Play/pause)	<p>When pressed, the playback controls appear. Using these controls, you can control the media content that is playing.</p> <p>Press the button to use the recording or Timeshift function while watching the broadcast.</p>
+/- (Volume)	Move the button up or down to adjust the volume. To mute the sound, press the button. When pressed for 1 second or more, the Accessibility Shortcuts appears.
^/∨ (Channel)	<p>Move the button up or down to change the channel. To see the Guide or Channel List screen, press the button.</p> <p>Press and hold the button up or down to quickly change the channel.</p>
 (Launch app button)	<p>Launch the app indicated by the button.</p> <ul style="list-style-type: none">  This function may not be supported depending on the model or geographical area.  This button is not supported in the BST model.





-  Use the Samsung Smart Remote less than 6 m from the TV. The usable distance may vary with the wireless environmental conditions.
-  The images, buttons and functions of the Samsung Smart Remote may differ with the model or geographical area.
-  To use the Samsung Smart Remote to control a compatible external device that does not support HDMI-CEC (Anynet+), you must configure universal remote control for the device. For more information, refer to "[Controlling External Devices with a Samsung Remote Control - Using the Universal Remote](#)".
-  To use the Samsung Smart Remote to control a compatible external device that does support HDMI-CEC (Anynet+), connect the device to an HDMI port on the TV using an HDMI cable. For more information, refer to "[Using Anynet+ \(HDMI-CEC\)](#)".
-  When you launch an app by pressing the button on the Samsung Smart Remote in [Portrait Mode](#), some apps may switch to Landscape according to their app policy.

Connecting the Samsung Smart Remote to the TV

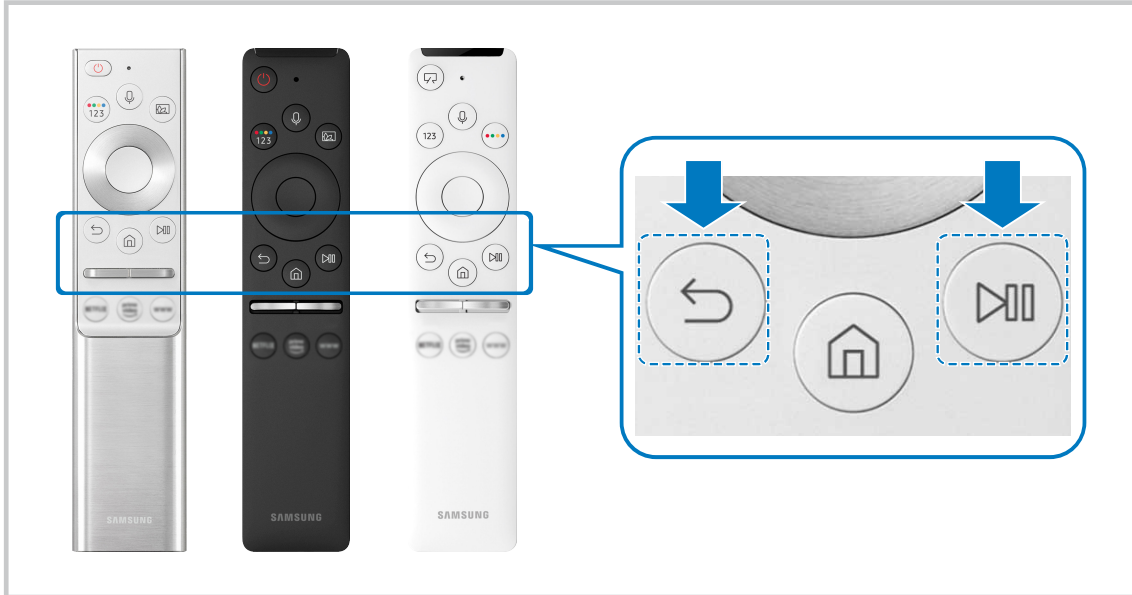
Connect the Samsung Smart Remote to your TV to operate the TV.

When you turn on the TV for the first time, the Samsung Smart Remote pairs to the TV automatically. If the Samsung Smart Remote does not pair to the TV automatically, point it at the front of the TV, and then press and hold the  and  buttons simultaneously for 3 seconds or more.









-  The images, buttons and functions of the Samsung Smart Remote may differ with the model or geographical area.
-  For more information about the Samsung Smart Remote, refer to "[About the Samsung Smart Remote](#)".
-  For more information about the Samsung Smart Remote that comes with The Frame, refer to "[About the Samsung Smart Remote \(The Frame\)](#)".
-  For more information about the Samsung Smart Remote that comes with The Sero, refer to "[About the Samsung Smart Remote \(The Sero\)](#)".

Controlling External Devices with a Samsung Remote Control - Using the Universal Remote

Control the TV and connected external devices with a Samsung remote control.

 >  [Source](#) > [Universal Remote](#)

You can control external devices connected to the TV using a Samsung remote control. To control external devices, register them by following the instructions on the screen.

-  This function may not be supported depending on the model or geographical area.
-  You can also use the [Anynet+ \(HDMI-CEC\)](#) function to operate external Samsung devices with your TV's remote control without any additional setup. For more information, refer to "[Using Anynet+ \(HDMI-CEC\)](#)".
-  Specific external devices connected to the TV may not support the universal remote feature.
-  Do not place any obstacles in front of an external device and TV's logo. It may cause signals from the remote control to be transmitted improperly.
-  The TV memorises both the external device and its connection port (HDMI 1, HDMI 2, etc.).
-  If you have difficulty controlling external devices with the Universal Remote, try adjusting the positions of the external devices.
-  This function may not operate properly depending on the TV installation environment and the features of external devices.

Using Anynet+ (HDMI-CEC)

Control an external device connected via Anynet+ (HDMI-CEC) with the remote control.

You can use the TV's remote control to control external devices that are connected to the TV by an HDMI cable and that support Anynet+ (HDMI-CEC). Note that you can only set up and operate Anynet+ (HDMI-CEC) with the remote control.

Connecting an external device through Anynet+ and using their menus









 >  **Settings** > **General** > **External Device Manager** > **Anynet+ (HDMI-CEC)** [Try Now](#)

1. Set **Anynet+ (HDMI-CEC)** to **On**.
2. Connect an HDMI-CEC-compliant device to the TV.
3. Turn on the connected external device.

The device is automatically connected to the TV. After the connection process is finished, you can access the menu of the connected device using your TV remote and control the device.

 The connecting process can take up to 2 minutes to complete.

Read before connecting an Anynet+ (HDMI-CEC) device

-  Anynet+ (HDMI-CEC)-enabled devices must be connected to the TV with an HDMI cable. Note that some HDMI cables may not support Anynet+ (HDMI-CEC).
-  You can configure the TV's Universal Remote to control third-party cable boxes, Blu-ray players and home theatres that do not support HDMI-CEC. For more information, refer to "[Controlling External Devices with a Samsung Remote Control - Using the Universal Remote](#)".
-  Anynet+ cannot be used to control external devices that do not support HDMI-CEC.
-  The TV remote control may not work under certain circumstances. If this occurs, set up the device as an Anynet+ (HDMI-CEC)-enabled device again.
-  Anynet+ (HDMI-CEC) works only with external devices that support HDMI-CEC and only when those devices are either in standby mode or turned on.
-  Anynet+ (HDMI-CEC) can control up to 12 compliant external devices (up to 3 of the same type) except for home theatres. Anynet+ (HDMI-CEC) can control only one home theatre system.
-  To listen to 5.1 channel audio from an external device, connect the device to the TV via an HDMI cable and connect a 5.1 home theatre system directly to the external device's digital audio output connector.
-  If an external device has been set up for both Anynet+ and a universal remote control, the device can be controlled only with the universal remote control.

Controlling the TV with a Keyboard, Mouse or Gamepad



Connecting a keyboard, mouse or gamepad to make it easier to control the TV.

 >  [Settings](#) > [General](#) > [External Device Manager](#) > [Input Device Manager](#) [Try Now](#)

You can connect a keyboard, mouse or gamepad to make it easier to control the TV.



Connecting a USB keyboard, mouse or gamepad

Plug the keyboard, mouse or gamepad cable into the USB port.

-  If you connect a mouse, it is available only in the [Internet](#) app and [Remote Access](#) function.
-  XInput USB gamepads are supported.
-  For more information, refer to [Input Device](#) in [Connection Guide](#) ( >  [Source](#) > [Connection Guide](#) > [Input Device](#)).

Connecting a Bluetooth keyboard, mouse or gamepad

 >  [Settings](#) > [General](#) > [External Device Manager](#) > [Input Device Manager](#) > [Bluetooth Device List](#)

-  If your device was not detected, position the keyboard close to the TV, and then select [Refresh](#). The TV scans for available devices again.
-  If you connect a mouse, it is available only in the [Internet](#) app.
-  For more information about how to connect a Bluetooth device, refer to the Bluetooth device's user manual.

Using the keyboard and mouse

Button	Description
Directional keys	Moves the focus
Windows key	Displays the TV settings
Enter key	Selects or runs a focused item
ESC key	Returns to the previous screen
F1 / F2 / F3 / F4 key	Colour buttons —  /  /  / 
F5 key	Displays the Home Screen
F6 key	Displays the Source screen
F7 key	Displays the Channel List
F8 key	Mutes the sound
F9 / F10 key	Adjusts the volume
F11 / F12 key	Changes the channel
Page Up / Page Down	Scrolls a web page displayed by the Internet app.
Left-click	Available only in the Internet app. You can click a menu or link to start a function as you do on a PC.
Right-click	Available only in the Internet app. You can use the following functions:  The options displayed in the menu may differ depending on the selected item. <ul style="list-style-type: none">• Open• Open Link in New Tab• Enable Scroll Mode

 The key operation may differ depending on some apps or the keyboard.

Setting up the input devices

🏠 > ⚙️ **Settings** > **General** > **External Device Manager** > **Input Device Manager**

- **Keyboard Settings**

You can set up the keyboard with the **Keyboard Language** and **Keyboard type** functions.

- **Mouse Settings**

You can set up the mouse with the **Primary Button** and **Pointer Speed** functions.

Entering Text using the On-Screen Virtual Keyboard

Use the virtual keyboard to enter text on your TV.

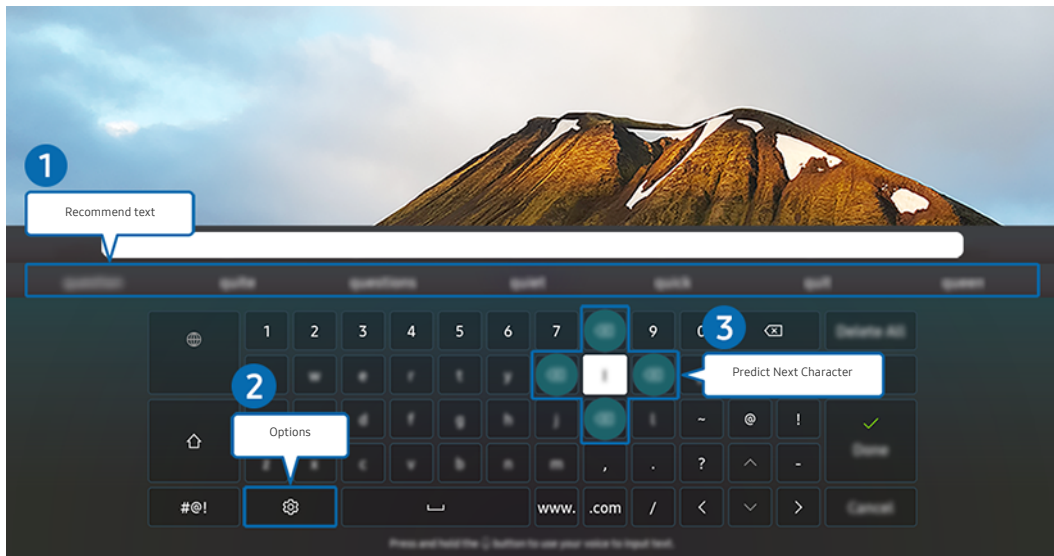

 The image on your TV may differ from the image above depending on the model and geographical area.

1 Recommend text

When you type a word you want to use as a search term, this function displays related suggestions from which you can choose one.

2 Options

Select  on the virtual keyboard screen. The following options are available:

 The options available may differ depending on the function running currently.

- [Recommend text](#)
- [Reset Recommended Text Memory](#)
- [Accented Character Preview](#)
- [Predict Next Character \(when using direction buttons\)](#)
- [Language](#)

3 Predict Next Character

Each time you type a character on the virtual keyboard, the next characters predicted to be typed are displayed. You can use the directional buttons on the remote control to select one.

Entering Text using the remote control's microphone and the on-screen virtual keyboard

When the virtual keyboard is on the screen, press and hold the button  on the Samsung Smart Remote, speak into the microphone on the Samsung Smart Remote, and then release the button. What you say appears on the screen as text.

 Entering text with your voice may not be supported for some functions.

 This function may not be supported depending on the model or geographical area.











Smart Features

You can enjoy various apps with Smart Hub.

Using Smart Hub

View descriptions of Smart Hub's basic functions.

From Smart Hub, you can use the Internet search function, install and use various apps, view photos and videos or listen to music stored on external storage devices, and perform more functions.

-  Some Smart Hub services are paid services.
-  To use Smart Hub, the TV must be connected to the Internet.
-  Some Smart Hub features may not be supported depending on the service provider, language or geographical area.
-  Smart Hub service outages can be caused by disruptions in your Internet service.
-  To use Smart Hub, you must agree to the Smart Hub service agreement and the collection and use of personal information. Without giving consent, you cannot use the additional features and services. You can view the entire text of the [Terms & Privacy](#) by navigating to  >  [Settings](#) > [Terms & Privacy](#). [Try Now](#)
-  If you want to stop using Smart Hub, you can cancel the agreement. To cancel the Smart Hub service agreement, select [Reset Smart Hub](#) ( >  [Settings](#) > [Support](#) > [Device Care](#) > [Self Diagnosis](#) > [Reset Smart Hub](#)).

Displaying the Home Screen

Press the  button.

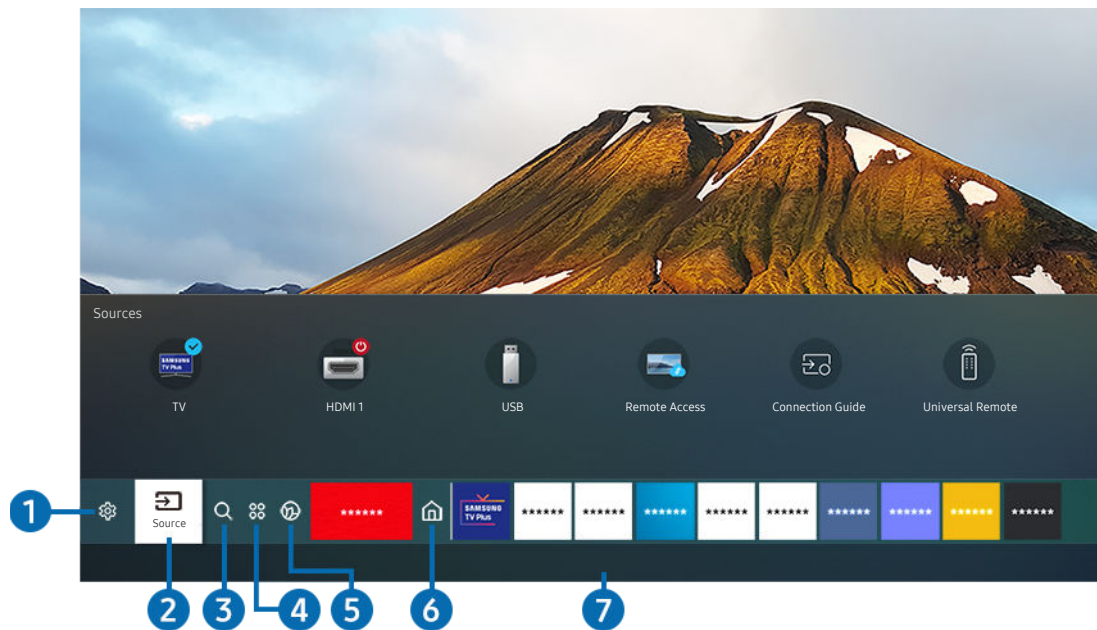

 The image on your TV may differ from the image above depending on the model and geographical area.

On the Home Screen, you can easily run the apps you have used previously or frequently. The apps can also be moved or deleted from the screen.

1 Settings

When the focus is moved to **Settings**, a list of quick settings icons appears above the top of the menu. You can quickly set frequently used functions by clicking the icons.

- **e-Manual**

You can open the user manual embedded in your TV.

- **Intelligent Mode**

In **Intelligent Mode**, the TV recognises and analyses the surroundings, noise, the content and your usage patterns to provide the best viewing experience. To turn **Intelligent Mode** on or off, press the Select button. To set the detailed options, press the up directional button, and then select **Intelligent Mode Settings**.

 This function is supported only in QLED TV (except for Q60T model), The Frame, The Serif, The Sero, The Terrace and The Terrace for business.

 For more information about the Intelligent Mode, refer to "[Using the Intelligent Mode](#)".

- **Picture Mode**

You can select the picture mode that provides the best viewing experience. To change the picture mode, press the Select button. To make fine adjustments, press the up directional button, and then select **Picture Setup**.

- **Sound Mode**

You can select a sound mode to optimise your listening experience. To change the sound mode, press the Select button. To make fine adjustments, press the up directional button, and then select [Equaliser Setup](#).

- **Sound Output**

You can select which speakers the TV uses for audio output. To change the audio output, press the Select button. To connect to a Bluetooth speaker, press the up directional button, and then select [Bluetooth Speaker List](#).

 Connecting Bluetooth speaker may not be supported depending on the model or geographical area.

- **Game Mode**

You can enable game mode to optimise the TV's settings for playing video games with a gaming console, such as a PlayStation™, Xbox™ or Nintendo Switch™. To turn **Game Mode** on or off, press the Select button. To set the detailed options, press the up directional button, and then select [Go to Game Mode Settings](#).

 For more information about Game Mode, refer to "[Setting the Viewing Environment for External Devices](#)".

 This function is only available when an external input source is being used.

- **Subtitle**

You can watch TV broadcasts with subtitles. To activate/deactivate the **Subtitle** function, press the Select button. To run [Accessibility Shortcuts](#), press the up directional button, and then select [Accessibility Shortcuts](#).

- **Audio Language**

You can change to the audio language you want to hear. To make fine adjustments, press the up directional button, and then select [Go to Audio Options](#).

- **Sleep Timer**

You can automatically shut off the TV after a pre-set period of time.

To set the sleep time to up to 180 minutes, press the Select button. To make detail off timer, press the up directional button, and then select [Set Up Off Timer](#).

- **Network**

You can view the current network and Internet status. Press the up directional button, and then select [Network Status](#) or [Network Settings](#).

- **Picture Size**

You can change to the picture size you want to view. To make fine adjustments, press the up directional button, and then select [Go to Picture Size](#).

- **Colour Tone**

You can select a colour tone suitable for your viewing preferences. To change to a colour tone that you want, press the Select button.

- **Picture Clarity**

You can optimise pictures that contain a lot of motions. To turn this function on or off, press the Select button. To set the detailed options, press the up directional button, and then select [Picture Clarity Settings](#).

- **Contrast Enhancer**

You can prevent excessive differences between bright and dark areas on the TV screen. To change the [Contrast Enhancer](#) setting, press the Select button.

- **Digital Output Audio Format**

You can select an output format for digital audio. Note that the [Dolby Digital+](#) option is only available via HDMI (eARC) for external devices that support the Dolby Digital+ format.

- **Colour Space**

You can set the spectrum of colours on the TV screen. To change to a colour space that you want, press the Select button. To set the detailed options, press the up directional button, and then select [Colour Space Settings](#).

- **Device Care**

You can run [Device Care](#) to diagnose and optimise your TV. [Device Care](#) can also check and optimise the TV's storage. If any trouble found, it can call for technical support.

- **All Settings**

Display the [Settings](#) menu.

 These functions may not be supported depending on the model or geographical area.

2 Source

You can select an external device connected to the TV.

 For more information, refer to "[Switching between external devices connected to the TV](#)".

3 Search

You can search for channels, programmes, movie titles and apps from Smart Hub.

 To use this feature, the TV must be connected to the Internet.

 This function may not be supported depending on the model.

4 Apps

You can enjoy a wide range of content including news, sports, weather and games by installing the corresponding apps on your TV.

 To use this feature, the TV must be connected to the Internet.

 For more information, refer to "[Using the Apps Service](#)".

5 Ambient Mode

You can enhance your living space with decorative content that matches the surroundings or view essential real-time information such as weather, time and news on the TV screen when you are not watching TV.

To return to the TV mode, press the  button in **Ambient Mode**. To shut off the TV, press the  button.

 If you use a remote control other than the Samsung Smart Remote, there may be restrictions to entering **Ambient Mode**.

 This function may not be supported depending on the model.

 For more information about the **Ambient Mode**, refer to "[Using the Ambient Mode](#)".

6 Home

This menu appears first when you press the  button. Then you can quickly use any of [Samsung Account](#), [Notification](#) or [Privacy Choices](#).

- [Samsung Account](#)

Go to the [Samsung Account](#) screen to create a new account or sign out of your account.

 For more information about the [Samsung Account](#), refer to "[Using a Samsung account](#)".

-  [Notification](#)

You can view a list of notifications for all events that occur on your TV. A notification appears on the screen when it is time to schedule viewing or schedule recording or when an event occurs on a registered device.

If you move the focus to [Notification](#), and then press the Select button, a notification window appears on the right and the following functions are available:

-  [Delete All](#)

You can delete all your notifications.

-  [Settings](#)

You can select services you want to be notified about.

When you select [Allow sound](#), notifications are displayed with a notification sound.

- [Privacy Choices](#)

You can view and set the privacy policy for Smart Hub and various other services.

7 Universal Guide

Universal Guide is an app that allows you to search for and enjoy various content such as TV shows, dramas and movies in one place. **Universal Guide** can recommend content tailored to your preferences.

You can use this feature on your mobile device with the Samsung SmartThings app.

 To enjoy the content from these apps on your TV, they must be installed on the TV.

 When you watch some paid content, you may need to make a payment using their associated app.

 Some content may be restricted depending on your network conditions and your subscriptions to paid channels.

 Parental control is necessary when children use this service.

 Images may look blurry depending on the service provider's circumstances.

 This function may not be supported depending on the geographical area.

Art

When you are not watching TV or when the TV is turned off, you can use the [Art](#) mode function to edit image content such as artworks or photos or to display the content.

 This function is supported only in The Frame.

 For more information, refer to the provided user manual.

Portrait Mode

When you do not use The Sero, you can rotate its screen vertically to see content such as photos, images, and time display.

 This function is supported only in The Sero.

 For more information, refer to the provided user manual.

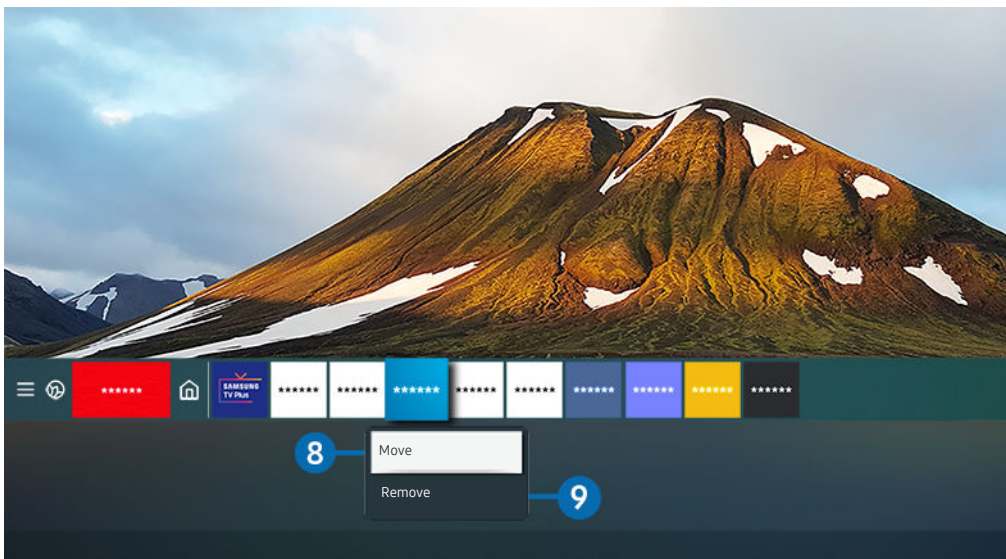

 The image on your TV may differ from the image above depending on the model and geographical area.

8 Moving an item on the Home Screen

Move the focus to the app you want to move, press and hold the Select button on the remote control, and then select **Move** in option menu. Move the app to the desired position by pressing the left or right directional button, and then press the Select button. The selected app is moved on the Home screen.

 In the region that does not support the Universal Guide, press the down directional button on the remote control.

9 Removing an item on the Home Screen

Move the focus to the app you want to delete, press and hold the Select button on the remote control, and then select **Remove** in option menu. The selected app is deleted.

 You can add the apps you want to use often to the Home Screen using Apps. To add your favourite apps to the Home Screen, refer to "[Managing installed apps](#)".

Launching Smart Hub automatically

 >  [Settings](#) > [General](#) > [Smart Features](#) > [Autorun Smart Hub](#) [Try Now](#)

When you set [Autorun Smart Hub](#) to **On**, the TV displays the Home Screen automatically when you turn the TV on. You can also turn this function on or off. Press the Select button at the current menu.

Launching the last used app automatically

 >  [Settings](#) > [General](#) > [Smart Features](#) > [Autorun Last App](#) [Try Now](#)

If [Autorun Last App](#) is set to **On**, the last used app is automatically run when you turn on the TV. You can also turn this function on or off. Press the Select button at the current menu.

 This function may not be supported depending on the app.

Testing Smart Hub connections

 >  [Settings](#) > [Support](#) > [Device Care](#) > [Self Diagnosis](#) > [Smart Hub Connection Test](#) [Try Now](#)

Resetting Smart Hub

 >  [Settings](#) > [Support](#) > [Device Care](#) > [Self Diagnosis](#) > [Reset Smart Hub](#) [Try Now](#)



 You can reset the Smart Hub settings. To reset Smart Hub, enter the PIN. The default PIN is "0000". You can set the PIN in

 >  [Settings](#) > [General](#) > [System Manager](#) > [Change PIN](#).

Using a Samsung account

Create and manage your own Samsung account.

 >  [Settings](#) > [General](#) > [System Manager](#) > [Samsung Account](#) [Try Now](#)

 You can view the entire text of the Terms & Privacy in  >  [Settings](#) > [General](#) > [System Manager](#) > [Samsung Account](#) > [My Account](#) > [Terms & Conditions, Privacy Policy](#) after logging in to your Samsung account.

 You can create a Samsung account at <http://account.samsung.com>. Once you have an account, you can use the same ID on both the TV and the Samsung website.

Signing in to a Samsung account

 >  [Settings](#) > [General](#) > [System Manager](#) > [Samsung Account](#) > [Sign In](#)

Creating a new account

 >  [Settings](#) > [General](#) > [System Manager](#) > [Samsung Account](#) > [Create Account](#)

Sign up for a Samsung account on your mobile or PC. Visit : <https://account.samsung.com>



Managing your Samsung account

 >  [Settings](#) > [General](#) > [System Manager](#) > [Samsung Account](#) > [My Account](#)

When you sign in to your Samsung account, you can use the following functions:

- [Sign out](#)

When multiple people share the TV, you can sign out of your account to prevent others from seeing it.

 To sign out of your [Samsung Account](#) ( >  [Settings](#) > [General](#) > [System Manager](#) > [Samsung Account](#)), move the focus to your account's icon, and then press the Select button. When a pop-up window appears, select [Sign out](#).

- [Edit profile](#)

You can edit your account information.

 To protect personal information, enter [Edit profile](#) and then [Sign-in Method](#) is set to [Profile image selection and password entry \(High security\)](#).

 If you want the TV to log you into your account automatically whenever you turn on the TV, click [Stay Signed In](#).

- [Payment Info](#)

You can view or manage your payment information.

- [Back up](#)

You can back up the TV settings to your Samsung Cloud storage. When resetting or replacing the TV, you can also restore its settings with the backed-up settings.

- [Sync Internet](#)

Once you sign in to your Samsung account and configure the [Sync Internet](#) settings, you can share the favourites and website bookmarks that you registered on other devices.

- [Remove Account](#)

You can delete an account from the TV. Although you have deleted your Samsung account from the TV, you are not unsubscribed. To unsubscribe from your Samsung Account, visit the Samsung Accounts website (<http://account.samsung.com>).

- [Terms & Conditions, Privacy Policy](#)

You can view the user agreement and privacy policy.

 For more information about the terms and conditions, privacy policy, select [View Details](#).

Using the Ambient Mode



Learn about the functions available in Ambient Mode.

🏠 > 🌐 Ambient Mode



You can enhance your living space with decorative content that matches the surroundings or view essential real-time information such as weather, time and news on the TV screen when you are not watching TV.

🔧 This function may not be supported depending on the model.

Entering Ambient Mode

To enter **Ambient Mode** from the TV viewing screen, press the  button or select  >  **Ambient Mode**.



🔧 If you use a remote control other than the Samsung Smart Remote, there may be restrictions to entering **Ambient Mode**.

🔧 When you select  >  **Ambient Mode**, The Sero rotates into Landscape and then enters the **Ambient Mode**.

Ambient Mode browser screen



🔧 The image on your TV may differ from the image above depending on the model and geographical area.

When you press the  or  button in **Ambient Mode**, the **Ambient Mode** browser screen appears at the bottom of the screen. In the **Ambient Mode** browser screen, you can select content and change the **Ambient Mode** settings.

1 Function and content preview

When you select a category at the bottom of the screen, a preview of available functions and content appears here. To view detailed information about a content item, move the focus to it, and then press the up directional button.

2 Ambient Settings

You can configure the following **Ambient Mode** settings:

 Available settings may differ depending on the model.

- **Auto Brightness**

Changes the auto brightness setting for **Ambient Mode**.

 When this function is set to **Off**, the brightness level of the TV screen is not automatically adjusted in response to the surrounding light level.

- **Sleep After**

Sets the time when the **Ambient Mode** screen turns off automatically.

 If there is no remote control input for the set time, the screen goes off.

- **Reset All Photos**

Resets the photos imported from your mobile device or Samsung Cloud.

 This function may not be supported depending on the model.

3 TV

You can enter the TV viewing screen.

4 Selecting a content category

You can select your preferred content and background for the **Ambient Mode** screen.

 You can use the SmartThings app on your mobile device to select the desired content and then change the settings.

 The Sero does not support the following functions in the SmartThings app on your mobile device.

 Available content categories may differ depending on the model or geographical area.

- **Routine**

Enjoy a range of routines, each displaying content to suit each part of your day or create your very own routines via the SmartThings app.

 This function may not be supported depending on the model.

- **Special Edition**

Allows you to enjoy creative artwork and interior design content created by the world's finest artists and designers.

- **Mood**

Enjoy a range of options to create the right ambience to suit your mood.

- **Relaxation**

Relax with a selection of calming content inspired by nature to soothe your mood.

- **Décor**

Allows you to select content with a sensible and beautiful design.

- **My Album**

Allows you to set a photo stored in your mobile device or Samsung Cloud as the wallpaper of the **Ambient Mode** screen.

 To import photos from your mobile device or Samsung Cloud, use the SmartThings app on your mobile device.

 For more information about how to configure the photo settings, select **View Help**. This function is available after you select a photo in the **My Album** category.

 This function may not be supported depending on the model.

- **Info**

Allows you to select essential real-time information such as weather, temperature, time and news.

 This function may not be supported depending on the geographical area.

- **Artwork**

Allows you to select content such as world famous photos and artwork.

 This function may not be supported depending on the model.

- **Background Theme**

Allows you to select a background theme provided by Samsung.

 Take a picture of a wall using the SmartThings app on your mobile device to create a custom background theme. When you use this function, there may be a delay in image transmission and optimisation depending on network conditions.

 You can set a background theme you created as a background of a content item. To set a background theme as the background of a content item, press the down directional button while watching the **Ambient Mode** screen.

- **Music Wall**

Enjoy listening to music in your living space. Visualisations are generated on your TV that alter and respond to the frequency of your music.

 This function may not be supported depending on the model.

- **About Ambient Mode**

You can view information about **Ambient Mode**.

Applying effects to the content

When you are enjoying content in **Ambient Mode**, press the down directional button to change the following settings for the content:

 Available functions may not be supported depending on the content.

- **Colour & Theme**

Changes the colour or theme of the content.

- **Vibes**

Selects a mood that matches the content.

 This function may not be supported depending on the content.

- **Backgrounds**

Changes the background of the content.

 This function may not be supported depending on the content.

 You can use the SmartThings app on your mobile device to take a picture of a wall and create a custom background. For more information, select the **How-To** icon. This function may be a delay in image transmission and optimisation depending on network conditions.

- **Shadow Effects**

Applies a shadow effect that you select to the content.

 This function may not be supported depending on the content.

- **Brightness**

Adjusts the brightness of the content.

- **Saturation**

Adjusts the saturation of the content.

- **Colour Tone**

Adjusts the colours of the content.



- **Red Tone / Green Tone / Blue Tone**

Adjusts the red, green, blue contrast.

Viewing detailed information about the content

When you are enjoying content in **Ambient Mode**, press the up directional button to view detailed information about the content.

Entering the TV viewing screen from Ambient Mode

To enter the TV viewing screen from **Ambient Mode**, press the  button or select  **TV** in the **Ambient Mode** browser screen.

 If you press the  button when the TV is turned off, the TV viewing screen appears.

Using Remote Access

Use the TV to access your PC via Remote PC, Screen Sharing (Wireless) or Cloud Service.

Home > Source > Remote Access

You can use the TV to access your PC via Remote PC, Screen Sharing (Wireless) or Cloud Service.





 For smooth use as in a computer, connect a keyboard and a mouse to your TV in advance.



 The image on your TV may differ from the image above depending on the model and geographical area.

Connecting a Remote PC

Provides **Remote Desktop Connection (RDP)** for remotely connecting to a PC running on Windows and **Virtual Network Computing (VNC)** for a PC running on Mac. To remotely connect to a PC, you must enter the IP address of the remote PC or select a saved profile. Enter a correct username and password and select a correct protocol. If there is any computer that can be accessed via the same network, the found IP and protocol are displayed.

-  To register a frequently used PC, move the focus to  [Manage User Profiles](#), and then press the Select button. When a pop-up window appears, select [Add](#), and then enter the PC information.
-  When your PC enters in power saving mode, connection is not available. It is recommended to cancel the power saving mode.
-  It is recommended to connect the wired network because the screen or sound may be interrupted depending on the network condition.

1) Configure your computer's settings to use the Remote Access function.

 Remote connection to a PC running on Windows via the RDP protocol is only supported for Windows 7 or later. And the operating system must be a Professional or higher edition.

 Remote connection to a PC running on Mac via the VNC protocol is only supported for Mac OS X 10.5 or later.

• Windows OS:

1. Right-click the **My Computer** icon on Desktop or Windows Explorer and then click **Properties**.
2. Click **Advanced System Settings**. The **System Properties** window appears.
3. Click the **Remote** tab and then select the **Allow Remote Assistance connections to this computer**.

• Mac OS:

1. Select **Menu > System > Preferences** and then click **Sharing**.
2. Select the **Screen Sharing** and **Remote Login** check box.
3. Run the resolution changing app downloaded from App Store and then change the resolution to 1440 x 900 or lower.

 If you do not change the resolution in Mac OS, the previous image may appear while connecting a remote computer.

2) Enter the required settings for connecting the computer remotely.

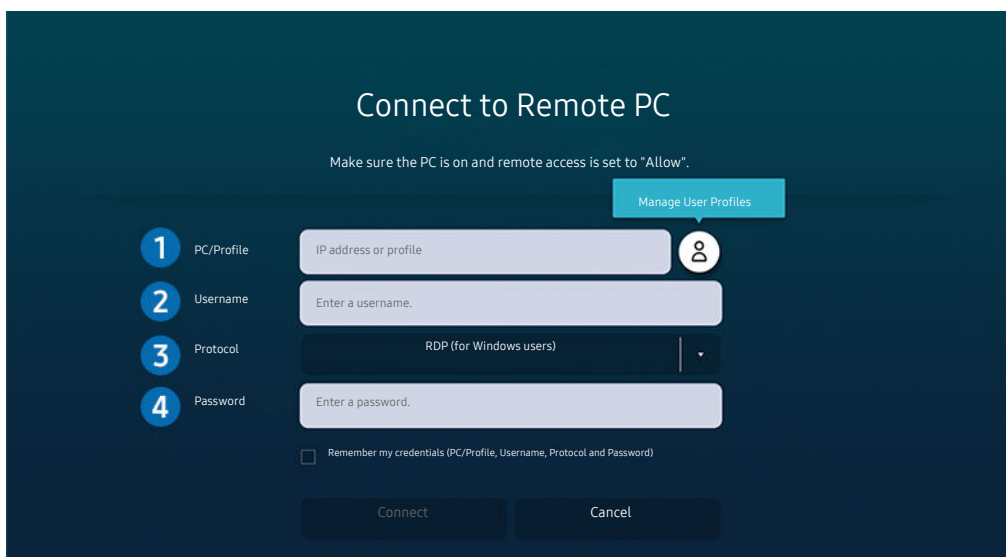

 The image on your TV may differ from the image above depending on the model and geographical area.

1 Enter the IP address of the PC you want to connect to.

- In case of Windows, when the computer to connect is within the same network (router/AP), run "cmd" command in **Settings > Network and Internet > View Network properties** or in **Start > Run**, and then run "ipconfig" to check the IPv4 address of the computer.

- In case of Mac, you can check the IP address in **Settings** > **Remote Access**.
- When the TV and computer are not within the same network, it is required to know the public IP and configure the router and AP. Check whether the router connected to the computer supports port forwarding. When the company provides additional security features such as firewall, seek help from a security officer.

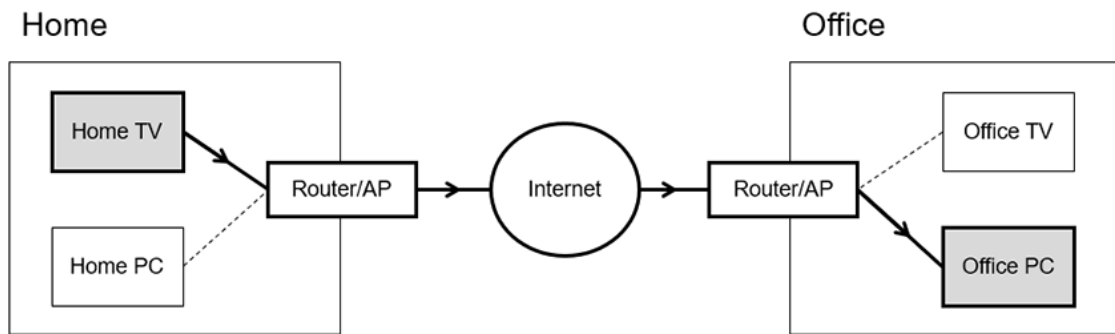

2 Enter the Username of the computer.

How to check the Username: Control Panel > User Account Control in Windows, System Preferences > Users & Groups in Mac.

3 Select the Protocol for the computer's OS. (Windows: RDP, Mac: VNC)

4 Enter the password for the login account.

For use of PIN, do not enter PIN but the specified password of the computer.

Playing Multimedia Content on a Remote PC

When you move the mouse cursor to the top of the screen after accessing a remote computer, the top bar appears. When the sharing folder icon is clicked in the top bar, the folders shared on Windows or Mac OS appear. You can play back any media content in a folder.

 For more information about playing multimedia content, refer to "[Playing pictures/video/music.](#)"

To use this function, the folder sharing option on the computer to access must have been enabled as shown below:

- Windows OS:
 1. Run Windows Explorer and then move to the folder to share.
 2. Right-click the folder and then click **Properties**.
 3. After the **Properties** window appears, click the **Sharing** tab and then click **Advanced Sharing**.
 4. After the **Advanced Sharing** window appears, select the **Share this folder** check box.
- Mac OS:
 1. Select **Menu > System Preferences** and then click **Sharing**.
 2. Select the **File Sharing** check box.
 3. To add a folder to share, click the **Add+** button at the bottom.
 4. Select a folder and then click **Add+**.

 It is recommended to connect the wired network because the screen or sound may be interrupted depending on the network condition.

 When playing a video file via a remote computer, the screen or sound breaking may be encountered.

Using Screen Sharing (Wireless)

Follow the instructions on the screen to adjust the PC settings and wirelessly connect the TV to the PC.

 This function is only available for PCs that support wireless screen sharing.

 This function is supported by Windows 10.

 You can connect AirPlay in Mac.

Using Samsung DeX



Samsung DeX can be connected from the TV via wireless network.

When the mobile device does not appear on the screen, select **Mobile Connection Guide** and then follow the screen instructions.

 This function is available only on mobile devices that support the wireless Samsung DeX.



Using Office 365

You can read or create a document after accessing the Office 365 website.

-  Run the browser in full screen mode.
-  URL modification is impossible in the Office 365 page.



Adding the Cloud Service

Select the [Add Cloud Service](#) icon. Use the bookmarking function of the browser, you can add or delete the cloud service link to or from [Remote Access](#).

-  To add the cloud service, you must be signed in to your Samsung account.
-  The number of cloud services that can be added to [Remote Access](#) is limited.

Using Cloud Service

You can access the cloud service by selecting the cloud service icon added to [Remote Access](#).



-  The screen on the web page may differ from that of a computer.
-  You can copy or paste any text. Some image formats are supported.
-  For easy and secured login in Cloud Service, [Remote Access Pass](#) is additionally supported as well as [Samsung Pass](#).

Setting [Samsung Pass](#) or [Remote Access Pass](#).

Set [Samsung Pass](#) or [Remote Access Pass](#) to Use in  >  [Source](#) > [Remote Access](#) > Run the [Remote Access](#) browser (Additionally select [Office 365](#) or [Add Cloud Service](#)) > [Internet Menu](#) > [Settings](#).

[Remote Access Pass](#) allows you to easily manage the cloud service ID and password without biometric authentication on mobile devices. For this purpose, you must be signed in to your Samsung account. The password is encrypted to be safely stored on your TV.

However, the log in to [Remote Access Pass](#) may not work depending on the site policy.

-  To securely access the cloud service, you can use the browser's automatic shutdown or clear the history logs.
-  Before accessing the cloud service, refer to "[Read Before Using the Internet Function](#)."

The cloud service supports the following keyboard shortcuts:



- F1: Returns to [Remote Access](#)'s Home screen.
- F8: Mutes the sound.
- F9/F10: Adjusts the volume.
- F11: Switches between full screen or default screen.

Using the Apps Service

Download and run various apps from Smart Hub.

> Apps

You can enjoy a wide range of content including news, sports, weather and games by installing the corresponding apps on your TV.

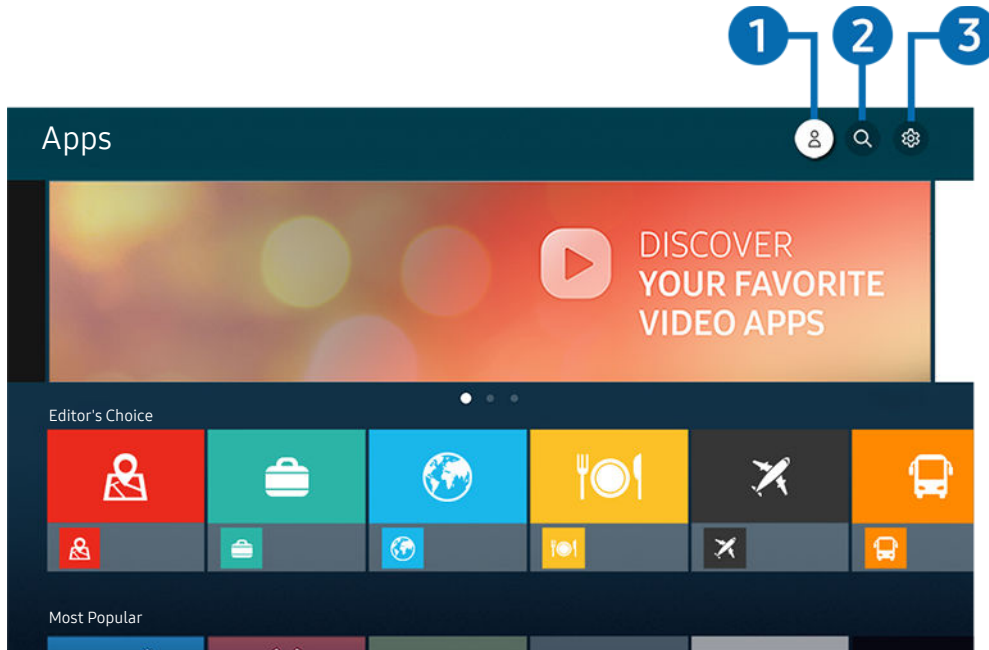

-  To use this feature, the TV must be connected to the Internet.
-  When Smart Hub is launched for the first time, the default apps are automatically installed. The default apps may differ depending on the geographical area.



 The image on your TV may differ from the image above depending on the model and geographical area.

1 Samsung Account

Go to the [Samsung Account](#) screen to create a new account or sign out of your account.

-  If you are signed out of your Samsung account, select  [Sign In](#) to sign in.
-  If you want to download new apps using [Apps](#), first sign in to your Samsung account.

2 App Search

You can search for available apps.

3 Settings

You can manage the installed apps.

Installing an app

1. Move to the app you want to install, and then press the Select button. The detailed information screen appears.
2. Select **Install**. When the installation is complete, the **Open** menu appears.
3. Select **Open** to run the app immediately.

 You can view installed apps on the **Settings** screen.

 If the TV's internal memory is insufficient, you can install some specific apps on a USB device.





 You can run an app installed on a USB device only when the USB device is connected to the TV. If the USB device is disconnected while an app is running, the app is terminated.

 You cannot run an app installed on a USB device on a PC or another TV.

Launching an app

You can run the app desired from **Downloaded App**.

The icons below appear within the selected app's icon and indicate the following:

-  : The app is installed on a USB device.
-  : The app has a password.
-  : The app needs to be updated.
-  : The app supports the mirroring function.

Managing installed apps

Select  **Settings** on **Apps**. You can manage installed apps.

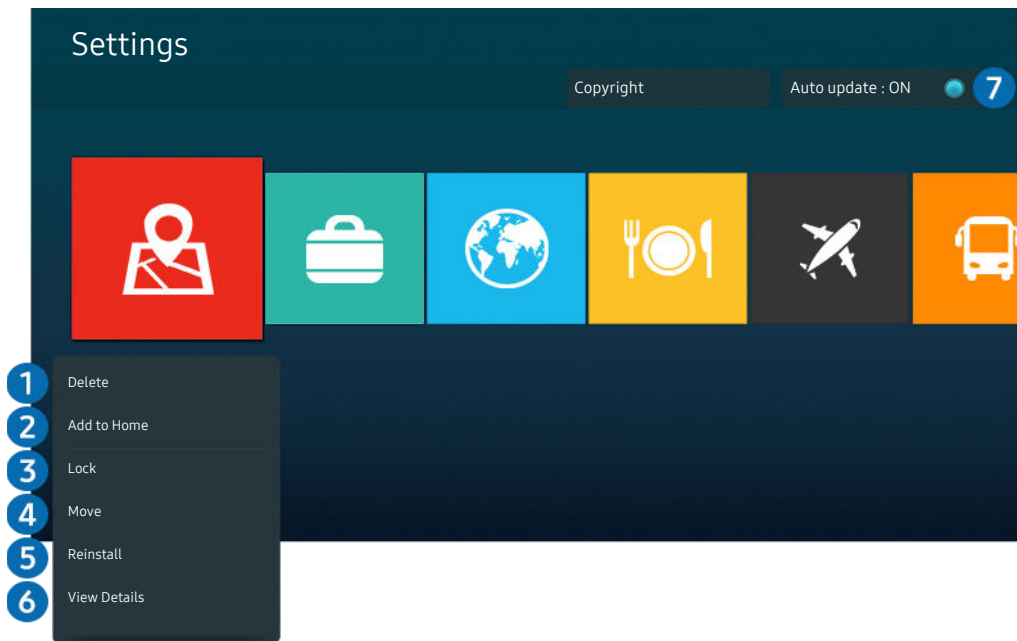

 The image on your TV may differ from the image above depending on the model and geographical area.

1 Removing an app

1. Select an app to delete.
2. Select **Delete**.

The selected app is deleted.

 Ensure that the related app data is also removed when you remove an app.

 Standard apps cannot be uninstalled.

2 Adding apps to the Home Screen

1. Select an app to add.
2. Select **Add to Home**.
3. After the Home screen appears, move the selected app to the desired location.
4. Press the Select button.



The selected app is added to the Home Screen.

 If the selected app is already added to the Home Screen, this function is disabled.

3 Locking and unlocking apps

1. Select an app to lock or unlock.
2. Select [Lock/Unlock](#).

The selected app is locked or unlocked.

 To lock or unlock an app, enter the PIN. The default PIN is "0000". You can set the PIN in  >  [Settings](#) > [General](#) > [System Manager](#) > [Change PIN](#).

4 Moving apps

1. Select an app to move.
2. Select [Move](#).
3. Move the app to the desired location.
4. Press the Select button.

The selected app is moved.

 This function may not be supported depending on the model or geographical area.

5 Reinstalling an app

1. Select the app to install again.
2. Select [Reinstall](#).

Reinstallation starts.

6 Checking the app information details

1. Select the app to check.
2. Select [View Details](#).

The app information screen appears.

 You can rate an app on the [View Details](#) screen.

7 Automatically updating apps

To automatically update the installed apps, set [Auto update](#) to **ON**.

 Automatic update is enabled only when the TV is connected to the Internet.

Using the Gallery App

View photos and videos synchronised with the Samsung Cloud.

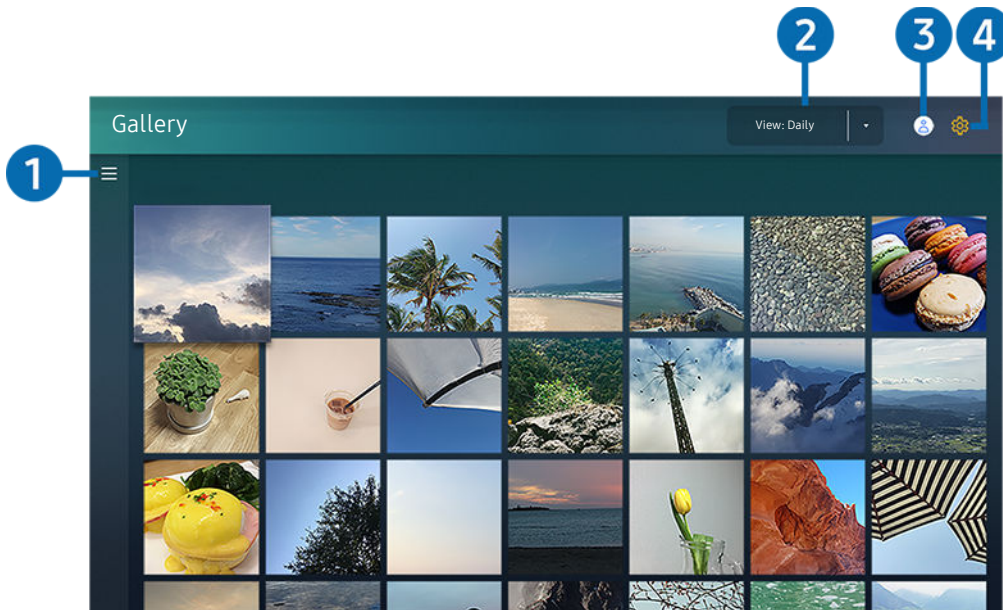

 > Gallery



 The image on your TV may differ from the image above depending on the model and geographical area.

You can enjoy various content synchronised with a mobile device that supports the Samsung Cloud. The available content types are photos, videos, stories and other content shared through your groups.

If you have shared content from your groups, you can access them in notifications.

-  To use the **Gallery** app, you must be signed in to your Samsung account that uses the Samsung Cloud.
-  To use this function, the PIN number is required.
-  This function may not be supported depending on the model.

1 Open category

Move to  at the top left of the screen using the directional buttons on the remote control to view by category the content synchronised with the Samsung Cloud.

2 **View: Daily / View: Monthly**

Sort the content by day or month.

3 **Samsung Account**

Go to the **Samsung Account** screen to create a new account or sign out of your account.

 If you are signed out of your Samsung account, select  **Sign In** to sign in.

4 **Gallery Settings**

Set a PIN for screen lock to restrict access to the **Gallery** app or view the terms and condition.

Using the SmartThings App

Monitor and configure the smart devices you have connected to the SmartThings service.

 > SmartThings

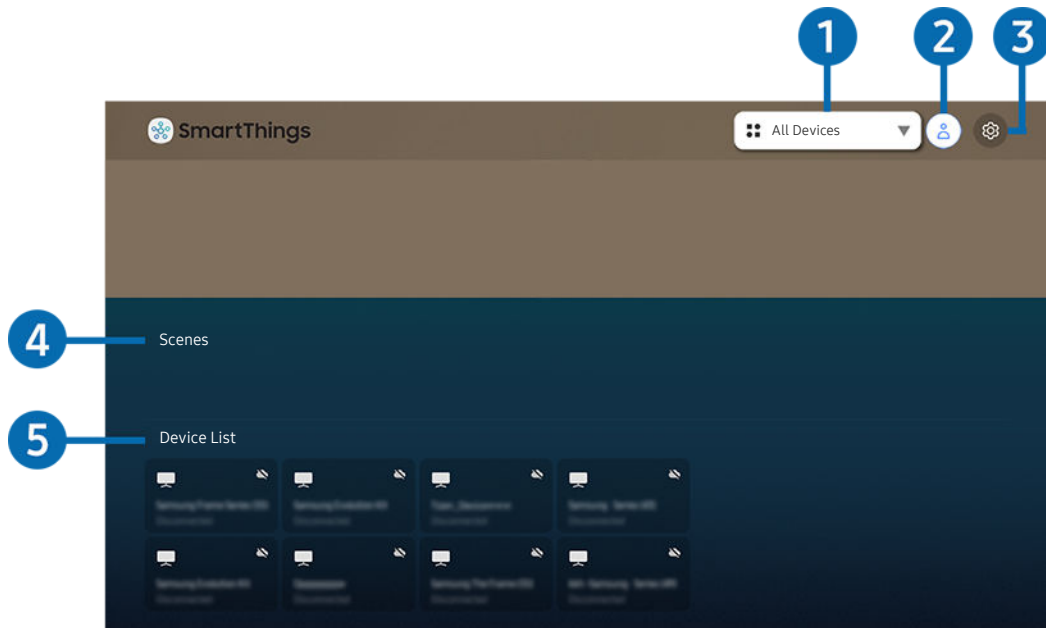

 The image on your TV may differ from the image above depending on the model and geographical area.

From your TV, you can monitor and configure smart devices you connected to the SmartThings service via the SmartThings app installed on them. You can receive notifications about the statuses of your connected devices.

 To use this function, you must be logged in to your Samsung account.

 This function may not be supported depending on the model or geographical area.

1 Location selection list

Press the Select button to identify all connected devices or the devices specific to a location.

2 Samsung Account

Go to the [Samsung Account](#) screen to create a new account or sign out of your account.

 If you are signed out of your Samsung account, select  [Sign In](#) to sign in.

3 Settings

Turn notifications on or off for the connected smart devices.

4 Scenes

Control multiple devices with one command after setting scenes via the SmartThings app on your mobile device.

5 Device list

View a list of the connected smart devices and their statuses.

You can add and control new devices through the SmartThings app on your mobile device. You can check and control various devices such as speaker, smart devices (IoT devices) and home appliances registered on the server. Please refer to the user guide of the SmartThings app on your mobile device for more details.

Controlling your TV with the mobile SmartThings app

You can register your TV and use some features of the TV through the SmartThings app on your mobile device.

Using the e-Manual

Control and read the manual embedded in your TV.

Launching the e-Manual

 >  [Settings](#) > [Support](#) > [Open e-Manual](#)

You can view the embedded e-Manual that contains information about your TV's key features.

 You can download a copy of the e-Manual from Samsung's website to view or print on your PC or mobile device (<http://www.samsung.com>).

 Some menu screens cannot be accessed from the e-Manual.

Using the buttons in the e-Manual

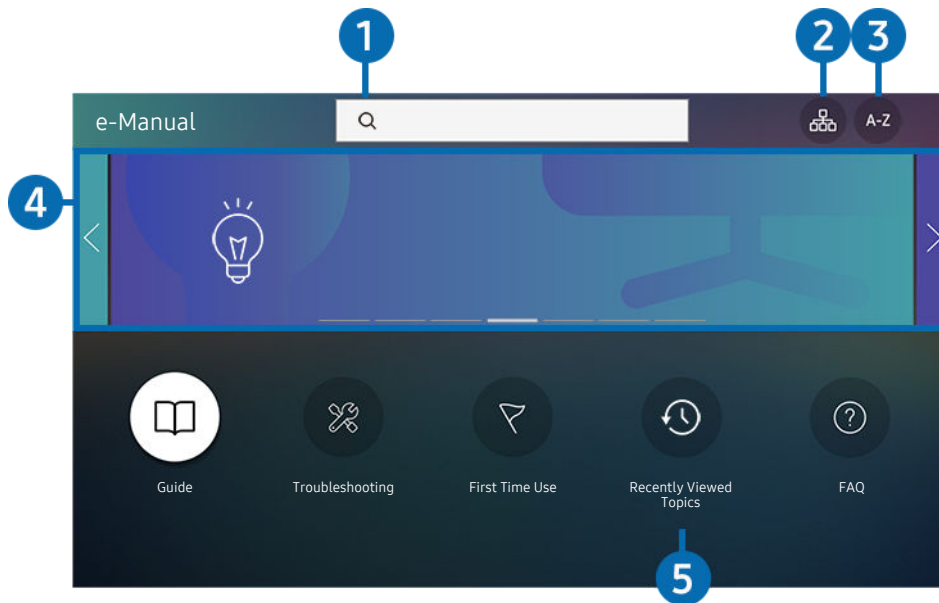

 The image on your TV may differ from the image above depending on the model and geographical area.

1 (Search)

Select an item from the search results to load the corresponding page.

2 (Site Map)

It displays the lists for each item in e-Manual.

3 A-Z (Index)

Select a keyword to navigate to the relevant page.

 This function may not be supported depending on the model or geographical area.

4 Moving to FAQ

You can find the troubleshooting of the selected symptom.

5 (Recently Viewed Topics)

Select a topic from the list of recently viewed topics.

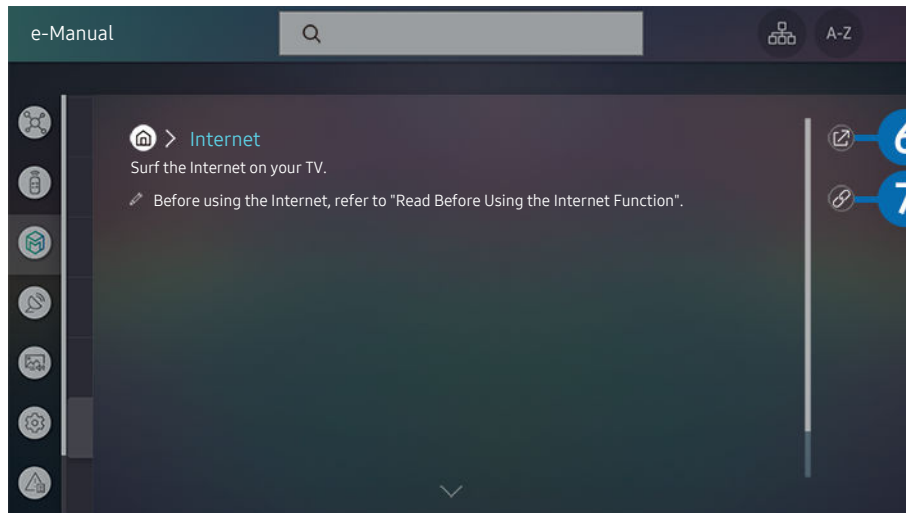

 Words in blue (e.g., [Internet](#)) indicate a menu item.

 The image on your TV may differ from the image above depending on the model and geographical area.

6 (Try Now)

Allows you to access the corresponding menu item and try out the feature right away.

7 (Link)







Access an underlined topic referred to on an e-Manual page immediately.

Using the Internet

Surf the Internet on your TV.

> Internet

When you run **Internet**, you can see recently viewed web sites or featured recommendations. When you select a desired web site, you can get immediate access to it.

-  You can use the **Internet** function more easily after connecting a keyboard and mouse.
-  You can scroll web pages with the directional button on the Samsung Smart Remote.
-  The web pages may differ from those on a PC.
-  Before using the **Internet**, refer to "Read Before Using the Internet Function".
-  The **Internet** app has an embedded **Samsung Pass** ( > **Internet** > **Internet Menu** > **Samsung Pass Settings**). With **Samsung Pass**, you can log in the website easily and securely. When you visit the website again, you can log in with **Samsung Pass** Biometrics Authentication on your mobile device without entering your ID and password. However, this **Samsung Pass** login may not work depending on the website policy. For this purpose, you must have been logged in the mobile device with a Samsung account registered in **Samsung Pass**.

Playing pictures/video/music

Play media content stored on your TV, USB devices, mobile devices, cameras, PCs, etc.

Home > Source > Connected Device [Try Now](#)

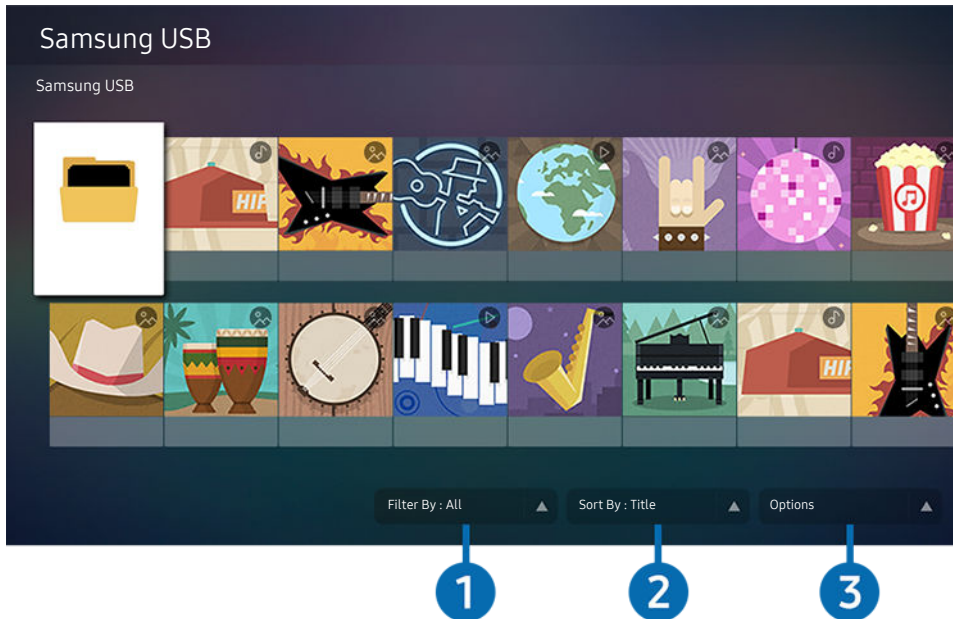

 The image on your TV may differ from the image above depending on the model and geographical area.

You can play media content saved on storage devices, such as USB devices, mobile devices and cameras on the TV.

 You cannot play media content if the content or the storage device is not supported by the TV. For more information, refer to "Read Before Playing Photo, Video or Music Files".

 Backup important files before connecting a USB device. Samsung is not responsible for damaged or lost files.

You can use the following functions on the media content list screen of a storage device.

1 Filter By

Filters the media content by type of media.

2 Sort By

Sorts the content list by **Title**, **Date** or **Channel**.

 This function may not be supported depending on the type of external device.

3 Options



Deletes or plays the selected media content in the media content list. When you select **Refresh**, the content list is reloaded.

 You can delete only the recorded content. To delete content, change the **Filter By** option to **Recorded**.

Playing multimedia content on a PC or mobile device



1. Select a device with media content in  >  **Source**. The media content list in the device appears.
2. Select a media content item from the list.

The selected content is played.

-  The content may not be played depending on the encoding method or file format. Furthermore, several functions may be restricted.
-  Content on devices connected to the TV via your network may not play smoothly due to network communication problems. If this occurs, use a USB device.

Playing multimedia content on a USB device

1. Connect a USB device to the USB port.
2. When a pop up message appears on the screen, select **Browse** to easily move to the list of multimedia content stored on the device.

-  If a USB device that contains the content you want to play is already connected to the TV, select the USB device in the  >  **Source** screen.



3. Select a content item to play from the list.

The selected content is played.

Listening to your mobile device sound through the TV speaker using Sound Mirroring

1. Search for and connect to your TV from the  (Bluetooth) device list on your mobile device.
2. Select media content to play on your mobile device.

The selected contents media is played through the TV speaker.

-  Some models enter **Ambient Mode**, **Art** mode or **Portrait Mode** automatically, and then play the selected media contents.
-  If the TV and the sound bar are connected wirelessly, the operation may be restricted.

Tune Station (MusicTV) functions

Tune Station is an all-purpose dashboard to simplify the entire musical experience when user wants to play music file from USB source.

It provides feature to user like themes, concert mode control, external speakers indicator - all from single display interface.

 This function may not be supported depending on the model or geographical area.

How to use Tune Station

Tune Station Registration

1. Search "Tune Station" from App Search and install Tune Station Launcher.
2. After Install, add to home. Now Tune Station App Icon will show on Home Screen.

When you select the Tune Station App icon in Home Screen, app will be launched in full screen and all Music files will be loaded, if USB is attached to TV.

Launching Tune Station

You can launch Tune Station in following ways:

1. Select Music files on USB storage device or hard disk drive attached to TV. On clicking Music File Tune Station App will be launched.
2. You can manually launch Tune Station from Home Screen. On launch it shows Music files if USB storage device is attached to TV.
3. On clicking any recent played songs from Home Screen, Tune Station App will be launched.

Buttons and functions available while playing multimedia content

Press the Select button while playing any video, photo or recorded content. The following buttons appear.

 The provided buttons and functions may not be supported depending on the model or geographical area.

 The available buttons and functions may differ with the content you are viewing or playing.

- **Pause / Play**

Pauses or plays the multimedia content.

- **Jump Backward / Jump Forward**

Press the up directional button to move the focus to the playback control bar, and then select the left or right directional button in the playback control bar to move backward or forward by 10 seconds in the video.

- **Move to a specific playback section, move up the focus on the playback bar, and then select one of the five thumbnails.**

 This function may not be supported depending on the file format.



- **Stop**

Stop the contents being played.





- **Previous / Next**

Displays the previous or the next multimedia content file.

- **Rewind / Fast Forward**







Rewinds or fast forwards the multimedia content. To increase the rewind or fast forward speed up to 3 times faster than normal, select the button repeatedly. To return to normal speed, select the  option or press the  button.

You can use the following functions when the video is paused. Note that with the video paused, the TV does not play audio.

- **Slow Rewind or Slow Forward:** Allows you to play a video slowly backward or forward by selecting the  or  option. There are 3 playback speeds. To change the playback speed, press the option repeatedly. To return to normal speed, select the  option or press the  button.

- **360 Mode**



Provides a 360-degree view for videos and photos.











-  This function may not be supported depending on the file format.
-  Video files using the mjpeg codec do not support a 360-degree view.
-  When a video or photo does not support a 360-degree view, applying 360 rotation to it may cause the screen to look distorted.
-  Videos may be interrupted if 360 rotation is applied during double speed playback.
-  Videos that support a 360-degree view may be interrupted if 360 rotation is simultaneously applied with other functions during playback.
-  This function may not be supported for some resolutions.
-  This function may not be supported depending on the model.



- **360 Auto Rotation**







Automatically adjusts the video's viewing angle by analysing the amount of image changes during playback of a video file that provides a 360-degree view. When this function is started, the rotation starts in a short time.

When **360 Auto Rotation** is focused, press the Select button to change to the following modes:

-  General
-  Dynamic
-  Natural

-  This function is only available when **360 Mode** is selected.
-  When **360 Auto Rotation** is activated, automatic adjustment is followed. The adjustment position may differ depending on the image.
-  The video's viewing angle is manually adjusted in General mode.
-  This function may not be supported depending on the file format.
-  Video files that use the mjpeg codec do not support a 360-degree view.
-  When a video does not support a 360-degree view, applying 360 rotation to it may cause the screen to look distorted.
-  Videos may be interrupted if 360 rotation is applied during double speed playback.
-  Videos that support a 360-degree view may be interrupted if 360 rotation is simultaneously applied with other functions during playback.
-  This function may not be supported for some resolutions.
-  This function may not be supported depending on the model.

- **Repeat**
Plays the current multimedia content repeatedly or all multimedia content files in the same folder repeatedly.
- **Shuffle**
Plays music files in random order.
- **Picture Off**
Plays music files with the screen off.
- **Fit to Screen**
Fits a photo to the screen.
- **Rotate left / Rotate right**
Rotates a photo left or right.
- **Zoom**
Zooms in a photo.
- **Background Music**
Pauses or resumes the background music while the TV displays photos.
 This function is available after enabling the **Background Music** option.
- **Options**
 The available options may differ with the model and content.

Function	Description
Slideshow Speed	<p>Sets the slideshow speed.</p> <p> If there is only one image file in the USB device, the slide show is not played.</p>
Slideshow Effect	<p>Applies transition effects to the slide show.</p> <p> If there is only one image file in the USB device, the slide show is not played.</p>
Background Music	<p>Plays background music as you set in the pop-up window while the TV displays photos.</p> <p> The music files must be saved in the same USB device as the photo files.</p> <p> To pause the background music, select Background Music on the playback screen bottom.</p>
Subtitles	<p>You can set the detailed subtitle options such as the language, sync, size and colour.</p> <p> If subtitles are not displayed correctly, check the encoding setting.</p>
Rotate	<p>Rotates the video.</p>
Audio Language	<p>Changes the audio language.</p> <p> This function is only available if the video supports multi-track sound.</p>
Information	<p>Displays detailed information about the current multimedia content.</p>

Using Bixby

Set Voice Assistant to Bixby. Speak into the microphone on your Samsung Smart Remote to control your TV.

- ✎ This function is available only if Voice Assistant is set to Bixby. (🏠) > ⚙️ **Settings** > **General** > **Voice** > **Voice Assistant**
- ✎ Bixby is available only when the TV is connected to the Internet.
- ✎ To use Bixby, you must register and sign in to your Samsung account. Some functions may not be supported if you are not signed in to your Samsung account.
- ✎ Bixby only supports some languages, and the supported functions may differ depending on the geographical area.
- ✎ Bixby may not be supported depending on the geographical area.

Starting Bixby with voice

You can immediately start a conversation with Bixby by saying "Hi, Bixby". Say "Hi, Bixby", and the Bixby icon at the bottom of the TV screen is activated in Listen mode. Continue speaking.

- ✎ The appropriate distance between user and the Samsung Smart Remote is 1.5 m. For more information on how to use this function, refer to "[Voice Assistant Issues](#)".
- ✎ This function is not supported in TU8 series, Q60T, The Frame, The Serif, The Sero, The Terrace and The Terrace for business.

Starting Bixby using buttons on the Samsung Smart Remote

You can have conversation with Bixby using the Samsung Smart Remote buttons. Press and hold the 🗣️ button on your Samsung Smart Remote, say a command, and then release the 🗣️ button.

To view the Bixby guide, press the 🗣️ button once:

- When you press the 🗣️ button, the **Explore Now** button appears at the bottom of the screen. Press the Select button to go to the **Explore Bixby** screen.

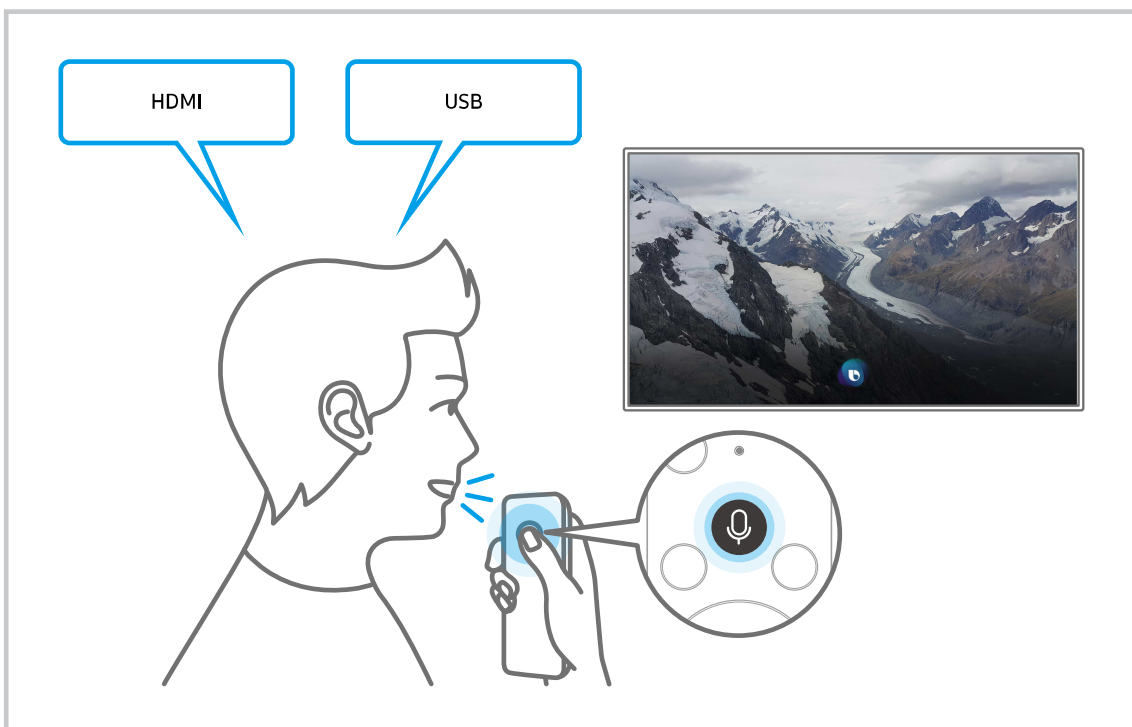

Learning about the Explore Bixby Screen

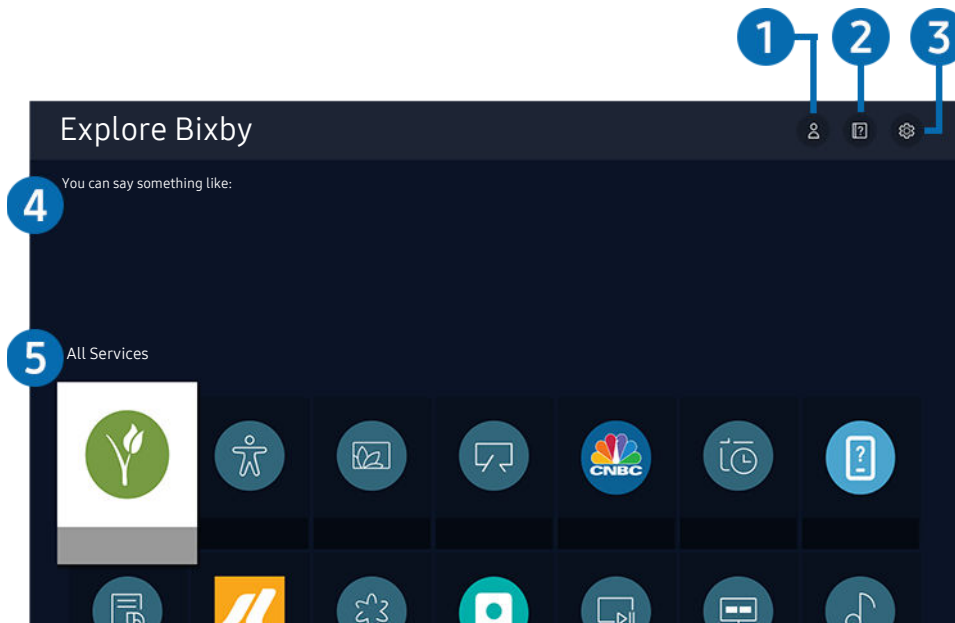

The image on your TV may differ from the image above depending on the model and geographical area.

1 My Profile

Go to the [My Profile](#) screen to create a new account or register a voice ID. When a voice ID is registered, you can log in with your voice and see the icon that Bixby generated for your voice.

You can delete a voice ID after selecting [My Profile](#). When the voice ID is deleted, its icon also disappears.

If you are signed out of your Samsung account, select [My Profile](#) to sign in.

2 Tutorials

The popup window on using Bixby appears.

3 Settings

You can change the settings for using Bixby.

These functions may not be supported depending on the model or geographical area.

These functions can be set in [Bixby Voice settings](#) (> [Settings](#) > [General](#) > [Voice](#) > [Bixby Voice settings](#)).

- [Language](#)

You can change Bixby's language.

The languages of the TV and other apps will not change.



Bixby only supports some languages.

- **Voice response**

You can change or turn off Bixby's voice.

 This function may not be supported depending on the language selected for Bixby.

- **Voice Wake-up**

You can configure this function to make Bixby respond to your voice. If Bixby does not respond to your voice, turn on the **Voice Wake-up** function, and then try again. ( > [Explore Now](#) >  [Settings](#) > [Voice Wake-up](#))

 The appropriate distance between user and the Samsung Smart Remote is 1.5 m. For more information on how to use this function, refer to "[Voice Assistant Issues](#)".

 The **Voice Wake-up** function may not be supported depending on the model or geographical area.

- **Sound feedback**

Play a sound when Bixby starts and stops listening.



 This function may not be supported depending on the model or geographical area.

- **Privacy**

You can permit or prohibit Bixby from utilising your personal information when you are using Bixby services.

4 Recommended commands

Displays recommended commands you can use to control the TV with Bixby given the current context.

If you do not want to see the recommended commands, set **Voice Hint** to **Off**. ( >  [Settings](#) > [General](#) > [Voice](#) > [Voice Hint](#))

5 All Services

You can learn the voice commands that let you use Bixby in various situations. Use the directional buttons to move to the desired command, and then press the Select button. You can operate the TV with various voice commands.

Read Before Using Bixby

- The supported voice interaction languages and features may differ depending on the geographical area.
- If the language set differs from the language of your country, some features are not available.
- Bixby is available only when the TV is connected to the Internet.
- Even if the TV is connected to the Internet, there may be no response due to a Bixby server error.

- The existing functional specifications may be changed if Bixby is updated.
 - Bixby is available only on TVs that support it and come with remote controls that have a microphone.
 - Symbols including "-" and special characters are not supported. Consequently, if a word or sentence contains numeric values or symbols, the function may not operate properly.
 - Searched results may not provide complete results.
 - You may be required to pay for some apps. Consequently, you may encounter a service application or contract.
 - To change the current channel by saying channel names as voice commands, you must finish [Set Up Your Service Provider](#). If [Set Up Your Service Provider](#) is not completed, you can complete it using [Reset](#) (🏠) > [Settings](#) > [General](#) > [Reset](#). [Try Now](#)
-  Service provider settings in initial setup may not be supported on geographical area.
- To use the voice text input function and the search function, you must consent to provisions allowing third parties to collect and use your voice data.
 - To use the Bixby function, you must:
 - Agree to Smart Hub's Terms of Use
 - Agree to a guidance regarding the collection and use of personal information for the Smart Hub service.
 - Consent to the collection and use of personal information for the voice interaction-based service.

Provisions for using Bixby

- The voice interaction rate differs with the volume/tone, pronunciation and ambient sound environment (TV sound and ambient noise).
- The optimal volume for voice commands is between 75 dB and 80 dB.

TV Viewing

You can use convenient features while watching TV. Additionally, you can edit the channel list or create favourite channel lists.

Using the Guide





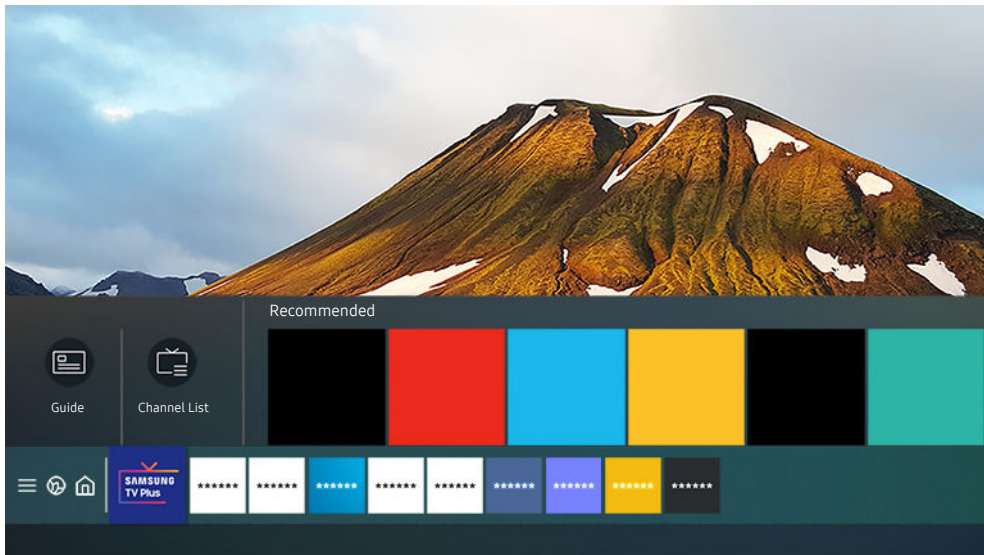

See an overview of each channel's programme lineup.

 > [Live TV](#) > [Guide](#) Try Now



 The image on your TV may differ from the image above depending on the model and geographical area.

In the [Guide](#), you can see the daily programme schedules for each broadcaster, see programme information, choose a programme to watch and set up a schedule viewing or recording.

-  To view the [Guide](#) while watching TV, press the \wedge/\vee (Channel) on the Samsung Smart Remote or press the GUIDE button on the standard remote control.
-  To see information about analogue channels and use the analogue channel functions of the [Guide](#), you must finish the service provider settings in initial setup.
-  Service provider settings in initial setup may not be supported on geographical area.
-  To view the [Guide](#), you must first set the TV's clock ( >  [Settings](#) > [General](#) > [System Manager](#) > [Time](#) > [Clock](#)).
-  Service provider settings in initial setup may not be supported on geographical area.

Move the focus to the programme you want in the [Guide](#), and then press and hold the Select button. You can use the following functions:

- **Record**

You can make a recording of a current programme.

 This function may not be supported depending on the model or geographical area.

- **Stop**

You can stop the recording function that is currently running.

 This function may not be supported depending on the model or geographical area.

- **Edit Recording Time**

You can change the start and end times of scheduled programme recordings.

 This function may not be supported depending on the model or geographical area.

- **Schedule Viewing**

You can schedule the viewing of a broadcast scheduled programme.

- **Schedule Recording**

You can schedule recording of a broadcast scheduled programme.

 This function may not be supported depending on the model or geographical area.

- **Cancel Scheduled Viewing / Cancel Scheduled Recording**

You can cancel scheduled viewings or recordings.

 This function may not be supported depending on the model or geographical area.

- **View Details**

You can see detailed information about the selected programme. The information may differ or may not be provided depending on the broadcast signal.

To move to the [Channel Filter](#) or [Aerial Type, Schedule Manager](#) screen: Press the  or  button. (If the remote control button is , press it twice.)

- **Channel Filter**

You can view channels and programmes categorised by the types defined in [Channel List](#).

- **Aerial Type**

You can change the type of broadcast signals the TV receives.

 This function may not be supported depending on the incoming broadcast signal.







- **Schedule Manager**

You can see the [Schedule Manager](#) or [Recording & Schedule Manager](#) screen.

 These functions may not be supported in the [Guide](#) depending on the model or geographical area.

Recording Programmes

Record a current or upcoming programme using a USB device instead of a video recorder.

-  This function may not be supported depending on the model or geographical area.
-  Read all precautions before using the recording feature. Refer to "[Before Using the Recording and Timeshift Functions](#)" for more information.
-  You can record only the programmes that are received through an aerial.
-  The  appears next to the programmes and channels scheduled for recording.
-  If you go to  > [Live TV](#) while no USB device is connected, the [Schedule Manager](#) screen appears in place of the [Recordings](#) screen.

Using the instant and schedule recording options from the Guide screen

- **Instant Recording**



Select a live programme from the [Guide](#), press and hold the Select button, and then select [Record](#) from the pop-up menu to start recording immediately.

- **Schedule Recording**

Select a programme scheduled to be broadcast, press the Select button, and then select [Schedule Recording](#) to set up a scheduled recording of the scheduled programme.

Using the instant and schedule recording options while watching a programme

- **Instant Recording**

If you select [Record](#) after pressing the  button twice or after pressing the  button once while watching a broadcast, recording starts.

- **Schedule Recording**

Press the Select button while watching a programme to display the programme info window. Use the left or right directional button to select a scheduled programme. Press the Select button, and then select [Schedule Recording](#) to set up a scheduled recording of the scheduled programme.

Scheduling a video recording after entering the date and time

 > [Live TV](#) > [Recordings](#) > [Schedules](#) > [Add Recording](#)

To schedule a recording, set the values for [Aerial](#), [Channel](#), [Repeat](#), [Date](#), [Start Time](#) and [End Time](#) of the broadcast programme to record, and then select [Save](#).

 Check the current time in  >  [Settings](#) > [General](#) > [System Manager](#) > [Time](#) > [Clock](#).

 The menus may not appear depending on the model or geographical area.

Managing the schedule recording list

 > [Live TV](#) > [Recordings](#) > [Schedules](#)

You can change scheduled recording information or cancel scheduled recordings.

 The menus may not appear depending on the model or geographical area.

 You can schedule up to 30 recordings or viewings at once using [Schedule Recording](#) and [Schedule Viewing](#).

- [Edit](#)

You can set the start and end times for a schedule recording. You can set the start time up to 10 minutes before the programme starts and the end time up to 10 minutes after the programme ends.

- [Delete](#)

You can delete scheduled recordings.

- [View Details](#)

You can view detailed information about scheduled recordings.

Viewing recorded programmes

 > [Live TV](#) > [Recordings](#) > [Recordings](#)

Select a file containing a recording from the list. The file is played back.

Move the focus to the recorded file, and then view [Play](#), [Delete](#) or [View Details](#) on the right menu.

 Buttons that appear may differ depending on the file being played. For more information about control buttons, refer to ["Buttons and functions available while recording a programme or Timeshift"](#).

 The menus may not appear depending on the model or geographical area.

Setting up a schedule recording start

 > [Live TV](#) > [Recordings](#) > [Settings](#)

 The menus may not appear depending on the model or geographical area.

- [Start Recording Early](#)

You can set the time to start the recording earlier than the broadcast start time in the programme guide.

- [Continue Recording After](#)

You can set the time to end the recording later than the broadcast end time in the programme guide.



- [Symbol Information](#)

Provide users with the information of the symbol and the explanation about an icon used in the schedule manager.

 The menus may not appear depending on the model or geographical area.

Setting Up a Schedule Viewing

Configure the TV to show a specific channel or programme at a specific time and date.

 The  appears next to programmes that have been configured for a scheduled viewing.

 To set up a schedule viewing, you must first set the TV's clock ( >  [Settings](#) > [General](#) > [System Manager](#) > [Time](#) > [Clock](#)).

Using the schedule viewing options from the guide screen

On the [Guide](#) screen, select a programme you would like to view, press and hold the Select button, and then select [Schedule Viewing](#) in the pop-up menu that appears.

Using the schedule viewing options while watching a programme

Press the Select button while watching TV. The Programme Info window appears. Select a programme that will be broadcast using the left or right directional buttons. Press the Select button, and then select [Schedule Viewing](#) to schedule viewing of that programme.

Using schedule viewing to view programmes at a specified time on a specified date

 > [Live TV](#) > [Schedule Manager](#) > [Add Viewing](#)

 > [Live TV](#) > [Recordings](#) > [Schedules](#) > [Add Viewing](#)

To schedule a viewing, set the values for [Aerial](#), [Channel](#), [Repeat](#), [Date](#) and [Start Time](#) of the broadcast programme to view, and then select [Save](#).

 Check the current time in  >  [Settings](#) > [General](#) > [System Manager](#) > [Time](#) > [Clock](#).

 This function may not be supported depending on the geographical area.

Setting the schedule Viewing Time

 > [Live TV](#) > [Schedule Manager](#)

 > [Live TV](#) > [Recordings](#) > [Schedules](#)

You can change scheduled viewing information or cancel scheduled viewings.

 You can set up a maximum total of 30 [Schedule Viewing](#) and [Schedule Recording](#) entries.

 The menus may not appear depending on the model or geographical area.

- [Edit](#)

You can set the start time of a scheduled viewing. If you choose a programme from the [Guide](#), the [Start Time](#) can be set to up to 10 minutes before the programme.

- [Delete](#)

You can delete scheduled viewings.

- [View Details](#)



You can view detailed information about scheduled viewings.







Using Timeshift

Play, pause or rewind live TV.

You can pause and rewind live TV by using **Timeshift**. Activating this function disables the **Broadcasting** function.



[Try Now](#)

To activate the **Timeshift** function while watching TV, press the  button twice or press the  button and then select **Timeshift** or press the  button.

-  This function may not be supported depending on the model or geographical area.
-  When the Timeshift function is running, some functions are not available in  >  **Settings** > **Broadcasting**.
-  To use Timeshift, you must connect a USB device for recording.
-  Read all precautions before using the Timeshift function. For more information, refer to "[Before Using the Recording and Timeshift Functions](#)".

Buttons and functions available while recording a programme or Timeshift



Review available buttons and functions of how they are used while recording a programme or Timeshift.

-  This function may not be supported depending on the model or geographical area.
-  The available buttons and functions may differ with the functions.

When you press the down directional button, the control bar appears and the following options are available:

- **Pause / Play**

You can use the following functions when the video is paused. Note that with the video paused, the TV does not play audio.

- **Slow Rewind** or **Slow Forward**: Allows you to play the video slowly (1/8, 1/4, 1/2) backward or forward by selecting the  or  option. To increase the rewind or forward speed in slow mode up to 3 times, select the option repeatedly. To return to normal speed, select the  option.

-  When the **Slow Rewind** function is activated, you can view the difference between the current recording time and the current rewind time.

- **Jump Backward / Jump Forward**

Press the up directional button to move the focus to the playback control bar, and then select the left or right directional button in the playback control bar to move backward or forward by 10 seconds in the video.

 When the Jump Backward function is activated, you can view the difference between the current recording time and the current rewind time.

- **Rewind / Fast Forward**

 This function is not available while you are watching a programme that is currently being broadcast.

- **Stop Recording / Stop Timeshift**

Ends the recording or Timeshift function.

- **Record**

You can switch from the Timeshift function to the recording function. When switching to the recording function, you can include the content recorded by the Timeshift function in the new recording.

 This function is only available when the Timeshift function is running.

- **Edit Recording Time**

You can set for what period of time the programme will be recorded.

 This function is only available when a programme is being recorded.

- **Go to Live TV**

Select to return to the current scenes of the programme when the Timeshift function is playing its past scenes.

- **Info**

Displays the programme info window of the programme you are recording or time-shifting.

Using the Channel List



Change the channel or check programmes on other digital channels.

> Live TV > Channel List

Using the **Channel List**, you can change the channel or check programmes on other digital channels while watching TV. On standard remote control, press the CH LIST button.

 The **Channel List** categories may vary depending on the incoming broadcast signals.

The **Channel List** screen contains the following icons:

-  : A favourite channel.
-  : A locked channel.
-  : CI card required channel.

If you press the left directional button when viewing the **Channel List** screen, you can use the following functions:

- **All**

Displays the channels that have been automatically searched.

 The channels received to the currently selected **Terrestrial**, **Cable** or **Satellite** are displayed.

 This function may differ depending on the model or geographical area.

- **Samsung TV Plus**

While the TV is connected to the Internet, you can watch popular programmes or highlights for each theme through a virtual channel at any time. As with regular channels, the TV provides the daily programme schedules for **Samsung TV Plus**.

 This function may not be supported depending on the model or geographical area.

- **Favourites**

Displays **Favourites 1** to **Favourites 5**.

 It displays only the favourites list that includes the favourite channel.

- **Channel Type**

Sorts the list so that it includes channels of a selected type. However, **Channel Type** can only be used channels contain the type information.

 This function may not be supported depending on the incoming broadcast signal.

- **Sort**

Sorts the list by **Number** or by **Name**.

 This option is only available on digital channels and may not always be available.

- **Terrestrial**, **Cable** or **Satellite**

Allows you to choose between **Terrestrial**, **Cable** and **Satellite**.

 This function may not be supported depending on the incoming broadcast signal.

 This function may not be supported depending on the model or geographical area.



 This function may differ depending on the model or geographical area.

Editing channels

Edit the channels stored on your TV.

 > [Live TV](#) > [Channel List](#) > [Edit Channels](#)

The [Edit Channels](#) screen icons indicate the following:

-  : A favourite channel.
-  : A locked channel.
-  : CI card required channel.

On the [Edit Channels](#) screen, you can select channels and use the following functions:

- [Delete](#)

After selecting a target channel to remove in [Edit Channels](#), select [Delete](#). Removed channels are not displayed in the [Channel List](#).

- [Lock / Unlock](#)

After selecting a target channel in [Edit Channels](#), select [Lock](#) or [Unlock](#). Then the channel is locked or unlocked. A locked channel cannot be viewed.

 If you want to use this function or set the password, set  >  [Settings](#) > [Broadcasting](#) > [Apply Channel Lock to On](#).

 For more information about how to set your password, refer to "[Setting up a password](#)".

- [Rename channel](#)

After selecting a channel to change in [Edit Channels](#), select [Rename channel](#) to change the channel name.

 You can rename only one channel at a time.

 This function is only available for analogue broadcasts.

- [Change Number](#)

After selecting a channel to change in [Edit Channels](#), select [Change Number](#) to change the channel number.

 This function may not be supported depending on the model or geographical area.

 When a channel number is changed, its channel information is not updated automatically.

- [Restore Samsung TV Plus](#)

You can restore the deleted [Samsung TV Plus](#) channels.

 This function may not be supported depending on the model or geographical area.

- [Save and Exit](#)

Saves and closes the [Edit Channels](#) screen.

Using a Personal Favourites List

Designate frequently watched channels as favourite channels.

Favourite channels are highlighted in the [Edit Channels](#) and [Channel List](#) screens with the ♥ symbol. You can create up to five favourites lists so that your family members can create their own personal favourites list.

Create a favourites list

 > [Live TV](#) > [Channel List](#) > [Edit Channels](#)

1. Press the left directional button on the remote control to select the desired [Favourites](#) list.
2. Press the right directional button to select [Add Channels](#).
3. Select the desired channel in the list on the screen.
4. Press [Add Channels](#) to add the selected channel in the [Favourites](#) list.

Select [Favourites 1](#) - [Favourites 5](#) on the [Edit Channels](#) screen and the following functions are available:

- [Add Channels](#)
In the channel list, select one or more channels to add in the favourites list and then select [Add Channels](#).
- [Remove](#)
Removes one or more channels from a favourites list.
- [Change order](#)
Changes the order of one or more channels selected in a favourites list.
- [Rename Favourites](#)
Renames a favourites list.
- [Save and Exit](#)
Saves and closes the [Edit Channels](#) screen.

TV-Viewing Support Functions

Use the functions that are available while watching TV.

Changing the broadcast signal

 > [Live TV](#) > [Channel List](#)

Press the directional button on your remote control, move the focus to [Terrestrial](#), [Cable](#) or [Satellite](#), and then press the Select button.

 You do not need to use this function if your TV is connected to a cable box or satellite box.

 The [Channel List](#) categories may vary depending on the incoming broadcast signals.

Scanning for available channels

 >  [Settings](#) > [Broadcasting](#) > [\(Auto Tuning Settings\)](#) > [Auto Tuning](#)

 This function may not be supported depending on the model or geographical area.

 If the TV is connected to a cable box or satellite box, you do not need to do this.

 The DVB-T2 system may not be supported depending on the geographical area.

 The [Auto Tuning Settings](#) may not appear depending on the model or geographical area.

Selecting the cable network search option

 >  [Settings](#) > [Broadcasting](#) > [\(Auto Tuning Settings\)](#) > [Cable Search Option](#)

Sets additional search options such as the frequency and symbol rate for a cable network search.

 This function may not be supported depending on the model or geographical area.

 The [Auto Tuning Settings](#) may not appear depending on the model or geographical area.

Scanning for available channels on standby mode

 >  [Settings](#) > [Broadcasting](#) > [\(Auto Tuning Settings\)](#) > [Standby Auto Tuning](#)

Automatically scan for channels while your TV is in standby mode.

 This function may not be supported depending on the model or geographical area.

 The [Auto Tuning Settings](#) may not appear depending on the model or geographical area.

Setting the Wake-up time

 >  [Settings](#) > [Broadcasting](#) > [\(Auto Tuning Settings\)](#) > [Wake-up Timer](#)

Schedule timer to turn the TV on and scan channels automatically.

 This function may not be supported depending on the model or geographical area.

 The [Auto Tuning Settings](#) may not appear depending on the model or geographical area.

Checking digital channel signal info and strength

 >  [Settings](#) > [Support](#) > [Device Care](#) > [Self Diagnosis](#) > [Signal Information](#) [Try Now](#)

 If your TV is attached to a separate, over-the-air antenna, you can use the signal strength information to adjust the antenna for increased signal strength and improved HD channel reception.

 [Signal Information](#) is only available for digital channels.

 This function may not be supported depending on the model or geographical area.

Restricting Viewing to Specific Channels

 >  [Settings](#) > [Broadcasting](#) > [Apply Channel Lock](#) Try Now

By selecting the menu, you can turn on or off the [Apply Channel Lock](#) function.

Lock specific channels to prevent children from watching adult content.

 To use this function, the PIN number is required.

Selecting the broadcasting audio option

 >  [Settings](#) > [Broadcasting](#) > [Dual Sound](#) Try Now

Set audio options for stereo or bilingual broadcasts. For more information, refer to "[Supported broadcasting audio options](#)".



 This function may not be supported depending on the model or geographical area.

Using Programme Rating Lock

 >  [Settings](#) > [Broadcasting](#) > [Programme Rating Lock](#) Try Now

 This function may not be supported depending on the model or geographical area.

This function is useful for controlling what programmes children can watch on the TV based on their ratings. [Programme Rating Lock](#) does not, however, block programmes originating from external sources, such as Blu-ray players, DVD players or USB files.

Every time you access [Programme Rating Lock](#), you must enter the security PIN. You must also enter this PIN to watch a blocked programme. The default PIN is "0000". To change the PIN, go to  >  [Settings](#) > [General](#) > [System Manager](#) > [Change PIN](#).

 For more information about how to set your password, refer to "[Setting up a password](#)".

 The [Broadcasting](#) is not available in HDMI or Component mode.

 [Programme Rating Lock](#) may not be supported depending on your input signal.

Configuring advanced broadcasting settings

 >  [Settings](#) > [Broadcasting](#) > [Expert Settings](#) Try Now

Showing common interface menu (For India Only)

 >  **Settings** > **Broadcasting** > **Common Interface**

You can view information about common interfaces.

 This function may not be supported depending on the model or geographical area.

- **CI Menu**

Show information and settings of CICAM.

- **Application Info**

Show the manufacturer of CICAM and information of CAS (Conditional Access System).

- **CICAM PIN Manager**

Manage Common Interface Common Access Module (CICAM) PIN. Save PIN or change stored PIN, and then set other PIN options.

 This function may not be supported depending on the model or geographical area.

- **Descramble Mode**

- **CAM video transcoding**

Configures the setting to transcode the video codec from the CAM automatically. Turn it Off if you do not want to use it.

 You must use a CAM that supports video codec transcoding.

Tuning broadcast signals manually

 >  [Settings](#) > [Broadcasting](#) > [Expert Settings](#) > [Manual Tuning](#) Try Now

You can scan for all the channels manually and store the scanned channels in the TV.

 This function may not be supported depending on the model or geographical area.

Tuning digital channels

 >  [Settings](#) > [Broadcasting](#) > [Expert Settings](#) > [Manual Tuning](#) > [Digital Channel Tuning](#)

Select [New](#), and then configure [Channel](#), [Frequency](#) and [Bandwidth](#), and then select [Search](#) to automatically scan and store a list of digital channels in the TV.

Tuning analogue channels

 >  [Settings](#) > [Broadcasting](#) > [Expert Settings](#) > [Manual Tuning](#) > [Analogue Channel Tuning](#)

Select [New](#) and configure [Programme](#), [Colour System](#), [Sound System](#), [Channel](#) and [Search](#) to scan for analogue channels. Then, select [Store](#) to store the scanned channels in the TV.

 This function is only available for analogue broadcasts.

Channel mode

- [P](#) (programme mode)
When tuning is complete, the broadcasting stations in your area have been assigned to position numbers from P0 to P99. You can select a channel by entering the position number in this mode.
- [C](#) (aerial channel mode) / [S](#) (cable channel mode)
These two modes allow you to select a channel by entering the assigned number for each aerial broadcasting station or cable channel.

Fine-tuning analogue broadcasts

 >  [Settings](#) > [Broadcasting](#) > [Expert Settings](#) > [Fine Tune](#) Try Now

 This function is only available for analogue broadcasts.

Transferring channel list

 >  [Settings](#) > [Broadcasting](#) > [Expert Settings](#) > [Transfer Channel List](#)

You can import or export the channel list to a USB storage. To use this function, the PIN number is required.

- [Import from USB](#): Imports channel list from a USB storage.
- [Export to USB](#): Exports channel list saved in the TV to a USB storage.

 This function is available when USB is connected.

 This function may not be supported depending on the model or geographical area.

Enabling/Disabling Edit Channel Numbers

 >  [Settings](#) > [Broadcasting](#) > [Expert Settings](#) > [Edit Channel Numbers](#)

Use this to change channel number. When channel number is changed, channel information is not updated automatically.

 This function may not be supported depending on the model or geographical area.

Changing teletext language

 >  [Settings](#) > [Broadcasting](#) > [Expert Settings](#) > [Teletext Language Settings](#) > [Teletext Language](#)

You can set or change the teletext language. To watch the teletext broadcast in your preferred language, select a language to use in [Primary Teletext Language](#). If this language is not supported, you can watch the teletext broadcast in your secondary preferred language set in [Secondary Teletext Language](#).

 This function may not be supported depending on the model, channel or geographical area.

Selecting the broadcast audio language

 >  [Settings](#) > [Broadcasting](#) > [Expert Settings](#) > [Audio Options](#) Try Now

Configure your preferred audio options for viewing broadcasted content. [Audio Options](#) functions differently for analogue and digital channels.

 This function may not be supported depending on the model or geographical area.

 This function may not be supported depending on the incoming broadcast signal.

- [Audio Language Settings](#)

You can change the audio language you want to hear.

 The available language may differ with the broadcast.

- [Audio Format](#)

You can change the audio format you want to hear.

 The supported audio format may differ with the broadcast programme.

 This option is only available on digital channels.

Showing TVkey Interface menu

 >  [Settings](#) > [Broadcasting](#) > [Expert Settings](#) > [TVkey Interface](#)

You can use the following functions:

- [TVkey Menu](#): Show TVkey Interface menu.
- [Delete TVkey Operator Profile](#): Show the TVkey operator list to delete.

 This function may not be supported depending on the model or geographical area.

Picture and Sound

You can change the settings for the picture and the sound according to your preference.

Using the Intelligent Mode

Let the TV analyse the surrounding and the content you are watching so that it can provide an upgraded viewing experience.

 >  **Settings** > **General** > **Intelligent Mode Settings**

In **Intelligent Mode**, the TV recognises and analyses the surroundings, noise, the content and your usage patterns to provide the best viewing experience. You can turn the options below on or off. Create your preferred viewing environment.

 This function is supported only in QLED TV (except for Q60T model), The Frame, The Serif, The Sero, The Terrace and The Terrace for business.

- **Intelligent Mode**

Improves your viewing experience by recognising your content, usage patterns and the environment around your TV.

- **Adaptive Picture**

Optimises brightness and provides the best picture quality in real time, based on the lighting condition and the content you're viewing.

 This function may not be supported by some modes or apps. (For example, **Ambient Mode** and **Game Mode**)

- **Active Voice Amplifier**





Analyses ambient noise and provides optimal sound depending on the noise.

 This function can be used only when the sound sensor at the bottom of the TV is active and the sound output is set to **TV Speaker**.

 While using this function, the TV does not save the data.



– Adaptive Sound+

Provides optimised sound quality by analysing the viewing space and the acoustic components of the content.

-  This function can be used only when the sound sensor at the bottom of the TV is active and the sound output is set to **TV Speaker**.
-  This function may not be supported by some modes or apps. (For example, **Ambient Mode**, **Game Mode** and apps that control the TV sound)
-  While using this function, the TV does not save the data.
-  This function may not be supported depending on the model.





– Adaptive Sound

Provides optimised sound quality by analyzing the viewing environment and the acoustic components of the content.

-  This function is only available when the sound output of the TV is set to **TV Speaker**.
-  This function may not be supported by some modes or apps (e.g., **Ambient Mode**, **Game Mode**, and apps that control the TV sound).
-  This function may not be supported depending on the model.

– Adaptive Volume

Automatically adjusts to a specific volume level while you are watching TV. The TV analyses your volume usage history by time period to automatically adjust the volume when you use an app or switch to an external input source.

-  This function is only available when the sound output of the TV is set to **TV Speaker**.
-  This function may not be supported by some apps or external devices.
-  This function's operation affects **Auto Volume** function, but it does not work the other way around.
-  This function operates based on your volume usage history and may not operate if the volume usage history by time period is insufficient.
-  The amount of difference made by this function does not exceed +/- 5 levels from the current volume and this function does not change the current volume if it exceeds 40.

Adjusting the Picture Quality

Change the [Picture Mode](#) and adjust [Expert Settings](#).

Choosing a picture mode



 >  [Settings](#) > [Picture](#) > [Picture Mode](#) [Try Now](#)

You can select the [Picture Mode](#) that provides the best viewing experience.

- [Dynamic](#)
Makes the picture brighter and clearer in bright viewing environments.
- [Standard](#)
Is the default mode suitable for general viewing environments.
- [Natural](#)
Reduces eye strain for a comfortable viewing experience.
- [Movie](#)
Is suitable for watching TV or movies in a dark room.

- [FILMMAKER MODE](#)





You can watch the source content (e.g. movie) as it is. The image defined as [FILMMAKER MODE](#) automatically switches to [FILMMAKER MODE](#) while watching.

-  [FILMMAKER MODE](#) may look darker than other picture modes.
-  You can change [FILMMAKER MODE](#) to a different [Picture Mode](#). However, the changed [Picture Mode](#) will be maintained even after watching the picture defined by [FILMMAKER MODE](#).
-  [FILMMAKER MODE™](#) logo is a trademark of UHD Alliance, Inc.

Configuring advanced picture settings

 >  [Settings](#) > [Picture](#) > [Expert Settings](#) [Try Now](#)

Configure the screen settings to your taste by using the following functions:

- [Brightness](#) [Try Now](#)
- [Contrast](#) [Try Now](#)
- [Sharpness](#) [Try Now](#)
- [Colour](#) [Try Now](#)
- [Tint \(G/R\)](#) [Try Now](#)
- [Apply Picture Settings](#) [Try Now](#)
- [Picture Clarity Settings](#) [Try Now](#)
 -  When **LED Clear Motion** is set to **On**, the screen appears darker than when it is **Off**.
- [Local Dimming](#)
 -  This function may not be supported depending on the model or geographical area.
 -  Controls the brightness of individual areas on the screen to maximise contrast automatically.
- [Contrast Enhancer](#) [Try Now](#)
- [Film Mode](#) [Try Now](#)
 -  This function is only available when the input signal is TV, AV, Component (480i, 576i, 1080i), or HDMI (1080i).
- [Colour Tone](#) [Try Now](#)
- [White Balance](#) [Try Now](#)
- [Gamma](#) [Try Now](#)
- [Shadow Detail](#) [Try Now](#)
- [RGB Only Mode](#) [Try Now](#)
- [Colour Space Settings](#) [Try Now](#)
- [Reset Picture](#) [Try Now](#)







Setting the Viewing Environment for External Devices

You can optimise the TV for viewing specific video formats.

Playing games on an optimised screen

 >  [Settings](#) > [General](#) > [External Device Manager](#) > [\(Game Mode Settings\)](#) > [Game Mode](#)



You can enable game mode to optimise the TV's settings for playing video games with a gaming console, such as a PlayStation™, Xbox™ or Nintendo Switch™.

-  The game mode is not available for normal TV viewing.
-  The screen may shake somewhat.
-  When [Game Mode](#) is enabled, [Picture Mode](#) and [Sound Mode](#) are switched to [Game](#) automatically. [Sound Mode](#) may not be automatically switched depending on the selected audio device on the [Sound Output](#) menu.
-  When [Game Mode](#) is set to [On](#), some functions are not available.
-  To use a different external device on the same port, remove the game console connection, set [Game Mode](#) to [Off](#), and then connect the external device to the port.
-  The [Game Mode](#) functions used for Nintendo Switch™ are subject to change without prior notice.

Adjusting the image quality of HDR game

 >  [Settings](#) > [General](#) > [External Device Manager](#) > [HGiG](#)

Set the optimal resolution based on the brightness for HDR game content.

-  When HDR sources are input in Game Mode, this menu is activated.
-  This function may not be supported depending on the model.

Setting the Game Mode details

 >  [Settings](#) > [General](#) > [External Device Manager](#) > [Game Mode Settings](#)

 These functions may not be supported depending on the model.

- [Surround Sound](#)

You can make your games more immersive by using intense, three-dimensional sound optimised for games.

- [Dynamic Black Equalizer](#)

You can easily detect items or hidden enemies lurking in dark corners by improving visibility and object details in dark scenes without washing out colours and contrast in brighter scenes.



- [Game Motion Plus Settings](#)

You can configure the Game Motion Plus settings.

Using Input Signal Plus

 >  **Settings** > **General** > **External Device Manager** > **Input Signal Plus** [Try Now](#)

Expands the input signal range for HDMI connections.

-  When you select the HDMI connector you want to use for **Input Signal Plus**, and then press the Select button to set the **Input Signal Plus** function to **On**, the TV screen may flicker.
-  When you connect the TV to an external device that supports only the UHD 24 Hz or UHD 30 Hz frequency or any FHD frequency, the **Input Signal Plus** function may not be available. In this case, turn off the **Input Signal Plus** function.
-  For more information about the supported UHD resolutions, refer to "[Supported Resolutions for UHD Input Signals](#)".

Using HDMI black level

 >  **Settings** > **General** > **External Device Manager** > **HDMI Black Level** [Try Now](#)

Use HDMI Black Level to adjust the black level to compensate for low black levels, low contrast or dull colours generated by external devices connected to the TV via an HDMI cable.

-  This function is only available when the input signal connected to the TV via an HDMI connector is set to RGB444.

Picture Support Functions

Configure the picture settings for your TV.

Changing the picture size settings

 >  **Settings** > **Picture** > **Picture Size Settings** [Try Now](#)

- **Picture Size** [Try Now](#)

You can change the size of the picture displayed on the TV screen to **16:9 Standard**, **Custom** or **4:3**.

 Supported picture sizes differ with the input signal. For more information about supported picture sizes, refer to "[Picture sizes and input signals](#)".

- **Auto Wide** [Try Now](#)

Changing the picture size automatically.

 This function may not be supported depending on the model or geographical area.

- **4:3 Screen Size** [Try Now](#)

You can select a picture size suitable for your geographical area while you are watching TV in the **4:3** or **Fit to screen** mode. The supported screen sizes differ with the country and this function allows you to adjust the picture size in this case.

 The **4:3** mode is not available when an external device is connected to the TV via a Component connector or an HDMI connector.

 This function may not be supported depending on the model or geographical area.

- **Fit to screen** [Try Now](#)

Fitting the picture to the screen.

 This function may not be supported depending on the **Picture Size** setting.

 This function may not be supported depending on the broadcast signals.

- **Zoom and Position** [Try Now](#)

Adjusting the picture size and/or position.

 This function is available only if **Picture Size** is set to **Custom**.

 To change the picture position on analogue channels, first enlarge the picture and then change the position.

 These functions may not be available on **Samsung TV Plus** and some applications.

Configuring a Sound Mode and Expert Settings

Change the Sound Mode and adjust Expert Settings.

Choosing a sound mode

 >  **Settings** > **Sound** > **Sound Mode** [Try Now](#)

You can select the available sound mode that you prefer for a content type or your listening environment.

 When an external device is connected, **Sound Mode** may change accordingly.

 This function may not be supported depending on the model.

Configuring advanced sound settings

 >  **Settings** > **Sound** > **Expert Settings** [Try Now](#)

You can personalise the sound quality by adjusting the following settings.

- **Balance** [Try Now](#)

- **Equaliser** [Try Now](#)

 This function is not available when the **Adaptive Sound+** function is turned on.

 This function is not available when the **Sound Mode** function is set to **Adaptive Sound** or **Amplify**.

 The name and properties of this function may appear differently depending on the connected external device.

- **HDMI-eARC Mode**

You can connect an audio device that supports eARC via HDMI-eARC. Muting occurs temporarily during device connection.

- **Digital Output Audio Format** [Try Now](#)

Select the digital audio output format. If you select the Auto option, the audio device automatically outputs in a supported format.

If you select the **Pass-through** option, audio data is output with no processing.

- **Digital Output Audio Delay** [Try Now](#)

 This feature is only available when the external device is connected via HDMI (eARC) and SPDIF (Sony Philips Digital Interface).

 This function may not be supported depending on the model.

- **Dolby Atmos Compatibility** [Try Now](#)

You can set the TV to allow Dolby Digital+ with Atmos streams that are inputted from external devices.

Set to **On** if the audio device connected via HDMI (eARC) supports Dolby Atmos. The TV screen may flicker when this function is turned on or off.

 If this function is on, set **Digital Output Audio Format** to **Auto**.

- **Auto Volume** [Try Now](#)

Automatically adjusts the sound to a certain level when changing channels or switching to another external input.

- **Sound Feedback** [Try Now](#)

- **Reset Sound** [Try Now](#)

 Standard audio signals are sampled at 48 kHz while HD audio signals are sampled at 96 kHz.

 Some SPDIF receivers may not be compatible with HD audio format.

Using the Sound Support Functions

Configure the sound settings for your TV.



Selecting speakers

 >  **Settings** > **Sound** > **Sound Output** [Try Now](#)

You can select which speakers the TV uses for audio output.

 External speakers may not be controlled with the Samsung remote control. When an external speaker is enabled, some sound menus are not supported.

Samsung TV supports the Q-Symphony function. This function works synchronised with the Samsung Soundbar that supports Q-Symphony so that your TV speaker and Soundbar simultaneously output the sound for best surround effects.

When a Samsung Soundbar that supports Q-Symphony is connected, the menu name such as "TV + Soundbar" appears under **Sound Output** ( >  **Settings** > **Sound** > **Sound Output**). Select the menu.

Menu name example) TV + [AV] Soundbar series name (HDMI) or TV + Optical

 It works based on the Codec supported by your TV. For more information about Codec information, refer to "[Read Before Playing Photo, Video or Music Files.](#)"

 This function is supported only when connected via HDMI or optical cable.

 This function is available only in some Samsung TVs and Soundbars released in 2020.

 Refer to the sound bar's user manual when connecting it to the TV.

Listening to the TV through Bluetooth devices

 >  **Settings** > **Sound** > **Sound Output** > **Bluetooth Speaker List**

You can connect Bluetooth audio devices to the TV. They must be paired using the TV's Bluetooth function. Refer to the user manual for your audio device such as Bluetooth speaker, sound bar and headphones for detailed connection and usage.

 If the TV fails to find a Bluetooth audio device, place the device closer to the TV, and then select **Refresh**.

 When you turn on a paired Bluetooth audio device, the TV detects it automatically, and then displays a pop-up window. Use this pop-up window to activate/deactivate the Bluetooth audio device.

 The sound quality may be affected by the condition of the Bluetooth connection.

 Before using a Bluetooth audio device, refer to "[Read Before Using Bluetooth Devices](#)".

Listening to the TV through a Samsung audio device that supports the Wi-Fi function

For more information about how to connect and use a Samsung audio device that supports the Wi-Fi function, refer to its user manual.

 >  [Settings](#) > [Sound](#) > [Wi-Fi Speaker Surround Setup](#) [Try Now](#)

If you've connected one or more Samsung wireless audio devices that support the Wi-Fi function to the TV, you can create an optimal sound set up by configuring the surround effect settings. You can select any of the surround sound configurations, with or without a sound bar.

A surround sound configuration can be used if all of the following conditions are met:

- Two or more Samsung wireless speakers of the same type must be connected to the same wireless network.
- The Samsung audio devices that support the Wi-Fi function must be connected to the same wireless network as the TV.

 Surround sound configurations with a sound bar may not be supported depending on the product.

 If you activate the Screen Mirroring function while using Samsung audio devices that support the Wi-Fi function, the Wi-Fi connection is disconnected.

 Mismatched video and audio lip-syncing may occur depending on the device type.

System and Support

You can configure system and support settings such as clock, timers, energy usage and software updates.

Using the Time Functions and the Timers

Set the current time and use the timer function.

 >  **Settings** > **General** > **System Manager** > **Time** Try Now

You can set the **Clock** manually or automatically. Once the **Clock** is set, you can view the current time on the TV anytime.

You must set the clock in the following cases:

- The power cable is disconnected and then connected.
- The **Clock Mode** is changed from **Auto** to **Manual**.
- The TV is not connected to the Internet.
- No broadcast signals are received.

Setting the clock automatically

 >  **Settings** > **General** > **System Manager** > **Time** > **Clock** > **Clock Mode** > **Auto**

 This function works only when the TV is connected to the Internet or is receiving digital broadcasts through a connected antenna.

 The accuracy of the time information received may differ with the channel and signal.

 If you get your TV signal from a cable broadcast receiver/set-top box or a satellite receiver/satellite set-top box connected to an HDMI or Component port, you must set the current time manually.

Adjusting the clock for DST and time zone

 >  **Settings** > **General** > **System Manager** > **Time** > **Clock** > **Time Zone**

Selects your time zone.

 This function is only available when the **Clock Mode** is set to **Auto**.

 This function may not be supported depending on the model or geographical area.

 This function may differ depending on the model or geographical area.

- **GMT**

Set Greenwich Mean Time (GMT).

- **DST**

Automatically adjust for Daylight Saving Time (DST).

Changing the current time

 >  **Settings** > **General** > **System Manager** > **Time** > **Clock** > **Time Offset**

Time Offset adjusts the time through a network connection.

 This function is available only when **Clock Mode** is set to **Auto**, the TV fails to receive time information through normal broadcast signals, and the TV is connected to the Internet through a local area network.

Setting the clock manually

 >  **Settings** > **General** > **System Manager** > **Time** > **Clock** > **Clock Mode** > **Manual**

When **Clock Mode** is set to **Manual**, you can directly enter the current date and time. Select the **Date** and **Time** by using the directional buttons on the remote control.

Using the sleep timer

 >  **Settings** > **General** > **System Manager** > **Time** > **Sleep Timer**

You can use this function to automatically shut off the TV after a pre-set period of time. You can set the sleep timer for up to 180 minutes after which it will turn off the TV.

 This function may not be supported in some viewing modes.

 This function may not be supported depending on the model or geographical area.

Turning off the TV using the off timer

 >  **Settings** > **General** > **System Manager** > **Time** > **Off Timer**

You can set **Off Timer** to shut off the TV automatically at a specific time. **Off Timer** is only available if the **Clock** has been set.

 To use this function, first set the **Clock** ( >  **Settings** > **General** > **System Manager** > **Time** > **Clock**).

 This function may not be supported in some viewing modes.

Using the Auto Protection Time and Energy Saving Functions

Set the Auto Protection Time and reduce the TV's energy consumption.

Setting the Auto Protection Time

 >  [Settings](#) > [General](#) > [System Manager](#) > [Auto Protection Time](#) [Try Now](#)

Activate a screensaver when your TV displays a still image for two hours or more.

 This function may not be supported in some viewing modes.

 This function may not be supported depending on the model or geographical area.

Reducing the energy consumption of the TV

 >  [Settings](#) > [General](#) > [Eco Solution](#) [Try Now](#)



You can adjust the brightness level of the TV, reduce overall power consumption and prevent overheating.

- [Ambient Light Detection](#) [Try Now](#)

Automatically adjusts the brightness level of the TV, according to the ambient light level, to reduce power consumption. If [Ambient Light Detection](#) has adjusted the screen brightness to a too bright or dark level, you can select [Minimum Brightness](#) to manually adjust the minimum screen brightness.

 This function is not available when the [Adaptive Picture](#) function is turned on.

- [Minimum Brightness](#) [Try Now](#)

When [Ambient Light Detection](#) is turned on, you can manually adjust the minimum brightness of the TV screen. This function acts only when the value is less than the setting in  >  [Settings](#) > [Picture](#) > [Expert Settings](#) > [Brightness](#).

 This function is not available when the [Adaptive Picture](#) function is turned on.

- [Energy Saving Mode](#) [Try Now](#)

Adjust the brightness settings to reduce the TV's power consumption.

 This function is not available when the [Adaptive Picture](#) function is turned on.

- [Motion Lighting](#) [Try Now](#)

Adjusts the brightness in response to on-screen movements to reduce power consumption.

 This function is not available when the [Adaptive Picture](#) function is turned on.

- [Auto Power Off](#) [Try Now](#)

Automatically turns off the TV to reduce unnecessary power consumption if the TV Controller and the remote control are not used for the set period of time.

Updating the TV's Software

View your TV's software version and update it if necessary.

 **DO NOT** turn off the TV's power until the update is complete. The TV will turn off and on automatically after completing the software update. Video and audio settings will be reset to their defaults after a software update.

 >  [Settings](#) > [Support](#) > [Software Update](#) 

Updating through the Internet

 >  [Settings](#) > [Support](#) > [Software Update](#) > [Update Now](#) 

 Updating from the Internet requires an active Internet connection.

Updating through a USB device

 >  [Settings](#) > [Support](#) > [Software Update](#) > [Update Now](#)

After downloading the update file from the Samsung website and storing it on a USB device, connect the USB device to the TV to update.

 To update using a USB device, download the update package from Samsung.com to your computer. Then, save the update package in the USB device's top-level folder. Otherwise, the TV will not be able to locate the update package.

Updating the TV automatically

 >  [Settings](#) > [Support](#) > [Software Update](#) > [Auto update](#) 

If the TV is connected to the Internet, you can have the TV's software update itself automatically while you are watching the TV. When the background update is completed, it is applied the next time the TV is turned on.

If you agree to the Smart Hub terms and conditions, [Auto update](#) is set to **On** automatically. If you want this function disabled, use the Select button to turn it off.

 This function may take a longer time if another network function is running concurrently.

 This function requires an Internet connection.

 For more information in The Terrace for business, refer to the provided user manual.

Audio and Video Functions for the Visually or Hearing Impaired



You can configure the functions for the visually or hearing impaired.

Running the accessibility functions

 >  **Settings** > **General** > **Accessibility** [Try Now](#)

Running Accessibility Shortcuts

The **Accessibility Shortcuts** provide easy access to the accessibility functions. To display the **Accessibility Shortcuts**, press and hold the Volume button for 1 second or more. You can easily turn on or turn off the functions such as **Voice Guide**, **Picture Off**, **Audio Description**, **Subtitle**, **High Contrast**, **Enlarge**, **Greyscale**, **Colour Inversion**, **Learn TV Remote**, **Menu Learning Screen**, **Multi-output Audio**, **Sign Language Zoom**, **Slow Button Repeat**, **Accessibility Settings**, etc.



-  On the standard remote control, press the AD/SUBT. button or press and hold the MUTE button.
-  Even if the **Voice Guide** is set to **Off** or muted, the voice guide for **Accessibility Shortcuts** is enabled.
-  The shortcut menus may not appear depending on the model or geographical area.

Enabling voice guides for the visually impaired

 >  **Settings** > **General** > **Accessibility** > **Voice Guide Settings** [Try Now](#)

You can activate voice guides that describe the menu options aloud to aid the visually impaired. To activate this function, set **Voice Guide** to **On**. With **Voice Guide** on, the TV provides voice guides for channel change, volume adjust, information on current and upcoming programmes, schedule viewing, other TV functions and various content in the **Internet** and in **Search**.

You can go to **Voice Guide**, and then press the Select button to turn the function on or off.

-  The **Voice Guide** is provided in the language that is specified on the TV **Language**. However, some languages are not supported by **Voice Guide** even though they are listed in the TV **Language**. **English** is always supported.
-  For more information about the TV **Language** settings, refer to "[Changing the menu language](#)".

Changing the volume, speed and pitch and the TV background volume of the Voice Guide

You can configure the volume, speed pitch and the TV background volume of the voice guide.

Audio Description

 >  [Settings](#) > [General](#) > [Accessibility](#) > [Audio Description Settings](#)

You can activate an audio guide that provides an audio description of video scenes for the visually impaired. This function is only available with broadcasts that provide this service.

 This function is only available on digital channels.

- [Audio Description](#)

Turns the audio description function on or off.

- [Audio Description Volume](#)

Adjusts the audio description volume.

The TV screen is turned off but audio continues

 >  [Settings](#) > [General](#) > [Accessibility](#) > [Picture Off](#)

Turn off the TV screen and provide only sound to reduce overall power consumption. When you press a button on the remote control other than Volume and Power while the screen is off, the TV screen turns back on.

 This function may not be supported depending on the geographical area.

White text on black background (high contrast)

 >  [Settings](#) > [General](#) > [Accessibility](#) > [High Contrast](#) [Try Now](#)

You can change Smart Hub and setting menu screens to white text on a black background and change the transparent TV menus to opaque automatically so that text can be more easily read.

 If [High Contrast](#) is on, some [Accessibility](#) menus are not available.

Setting the screen to black and white

 >  [Settings](#) > [General](#) > [Accessibility](#) > [Greyscale](#) [Try Now](#)

You can change the colour of the TV screen to black and white to sharpen blurred edges caused by colours.

 If [Greyscale](#) is on, some [Accessibility](#) menus are not available.

 This function may not be supported depending on the model or geographical area.

Inverting the screen colour

 >  [Settings](#) > [General](#) > [Accessibility](#) > [Colour Inversion](#) [Try Now](#)

You can invert the colours of the text and background for the setting menus displayed on the TV screen to make it easier to read them.

 If [Colour Inversion](#) is on, some [Accessibility](#) menus are not available.

 This function may not be supported depending on the model or geographical area.

Enlarging the font (for the visually impaired)

 >  [Settings](#) > [General](#) > [Accessibility](#) > [Enlarge](#) [Try Now](#)

You can enlarge the size of the font on the screen. To activate, set [Enlarge](#) to [On](#).

Learning about the remote control (for the visually impaired)

 >  [Settings](#) > [General](#) > [Accessibility](#) > [Learn TV Remote](#) [Try Now](#)

This function helps individuals with a visual impairment to learn the positions of the buttons on the remote control. When this function is activated, you can press a button on the remote control and the TV will tell you its name. Press the  button twice to exit [Learn TV Remote](#).

 This function is only available when [Voice Guide](#) is enabled.

Learning about the TV menu

 >  [Settings](#) > [General](#) > [Accessibility](#) > [Menu Learning Screen](#) [Try Now](#)



Learn the menus on the TV screen. Once enabled, your TV will tell you the structure and features of the menus you select.

 This function is only available when [Voice Guide](#) is enabled.

Watching TV broadcasts with subtitles

 >  [Settings](#) > [General](#) > [Accessibility](#) > [Subtitle Settings](#) [Try Now](#)

Set **Subtitle** to **On**. Then you can watch the programme with the subtitle displayed.

-  This function may not be supported depending on the model or geographical area.
-  This function has no relationship with the features for controlling sub-titles of DVD or Blu-ray players. To control DVD or Blu-ray subtitles, use the sub-title feature of the DVD or Blu-ray player and the player's remote control.

- [Subtitle](#)
Turns on or off the subtitle.
- [Subtitle Mode](#)
Sets the subtitle mode.
- [Subtitle Language](#)
Sets the subtitle language.
- [Spoken Subtitles](#)
Listen to an audio version of the subtitles. Only available with broadcasts that provide this service.

Selecting the broadcasting subtitle language

You can select the default subtitle language. The list may vary depending on the broadcast.

- [Primary Subtitle Language](#)
Sets the primary subtitle language.
- [Secondary Subtitle Language](#)
Sets the secondary subtitle language.

Listening to the TV through Bluetooth devices (for the hearing impaired)

 >  [Settings](#) > [General](#) > [Accessibility](#) > [Multi-output Audio](#)

You can turn on both the TV speaker and Bluetooth headphone at the same time. When this function is active, you can set the volume of the Bluetooth headphone higher than the volume of the TV speaker.

 This function may not be supported depending on the model or geographical area.

 When you connect the Bluetooth headphone to the TV, [Multi-output Audio](#) is activated. For more information about connecting Bluetooth devices to the TV, refer to "[Listening to the TV through Bluetooth devices](#)".

Enlarging the sign language screen for the hearing impaired

 >  [Settings](#) > [General](#) > [Accessibility](#) > [Sign Language Zoom Settings](#) [Try Now](#)

You can zoom in the sign language screen when the programme you are watching provides it. First, set [Sign Language Zoom](#) to [On](#), and then select [Edit Sign Language Zoom](#) to change the position and magnification of the sign language screen.

Configuring the repeat settings for remote control buttons

 >  [Settings](#) > [General](#) > [Accessibility](#) > [Remote Button Repeat Settings](#) [Try Now](#)

You can configure the operation speed of the remote control buttons so that they slow down when you continually press and hold them. First, set [Slow Button Repeat](#) to [On](#), and then adjust the operation speed in [Repeat Interval](#).

App for the Visually Impaired (SeeColors App)

You can download [SeeColors](#) App in  > [Apps](#).

This application helps colour blind people feel rich colours on TV through a simple self-check. Through self-check, colours are changed to be suitable so that each person can experience a richer view of colours.

 When the [SeeColors](#) App is run, specific menus are disabled.

 This function may not be supported depending on the model.

Using Voice Assistants on TV

You can change the settings of a Voice Assistant after selecting it.

Select the Voice Assistant

 >  **Settings** > **General** > **Voice** > **Voice Assistant**

Select which **Voice Assistant** you would like to help control your TV.

 To use this function, the TV must be connected to the Internet.

 This function may not be supported depending on the model or geographical area.

 **Voice Wake-up** may not be available depending on the **Voice Assistant** and language.

- **Bixby / Amazon Alexa / Google Assistant**

 To use the **Voice Assistant**, follow the instructions on the TV screen to enable the selected **Voice Assistant**.

 To change the settings for **Voice Assistant**, run the Settings menu under each **Voice Assistant** ( >  **Settings** > **General** > **Voice** > **Voice Assistant**).

 To enable the Settings menus for each **Voice Assistant**, log in each **Voice Assistant**.

 For an example of Voice command, see the Settings menus for each **Voice Assistant**.

Using Other Functions

You can view other functions.

Changing the menu language



 >  [Settings](#) > [General](#) > [System Manager](#) > [Language](#) [Try Now](#)

Setting up a password

 >  [Settings](#) > [General](#) > [System Manager](#) > [Change PIN](#) [Try Now](#)

The PIN input window appears. Enter a PIN. Enter it again to confirm it. The default PIN is "0000".

 If you forget your PIN, you can reset it with your remote control. With the TV turned on, press the following buttons on the remote control in the order shown to reset the PIN to "0000".

On the Samsung Smart Remote: Select **+/-** (Volume) button. > Volume Up >  > Volume Down >  > Volume Up > .

On the standard remote control: Select  button. > **(+)** (Volume Up) > Select RETURN button. > **(-)** (Volume Down) > Select RETURN button. > **(+)** (Volume Up) > Select RETURN button.

Selecting Usage or Retail Mode

 >  [Settings](#) > [General](#) > [System Manager](#) > [Usage Mode](#) [Try Now](#)

You can set the TV for retail environments by setting [Usage Mode](#) to [Retail Mode](#).

 For all other uses, select [Home Mode](#).

 Use [Retail Mode](#) only in a store. With [Retail Mode](#), some functions are disabled and the TV settings automatically reset after a preset amount of time.

 This function may not be supported depending on the model.

Managing External Devices

 >  [Settings](#) > [General](#) > [External Device Manager](#) > [Device Connection Manager](#) [Try Now](#)

When you connect external devices such as mobile devices or tablets connected to the same network as the TV so you can share content, you can view the list of allowed devices and connected devices.

- [Access Notification](#)

Set whether to display a notification when an external device such as a mobile device or tablet attempts to connect to the TV.

- [Device List](#)

Manage a list of external devices registered to the TV.

Using AirPlay

 >  [Settings](#) > [General](#) > [Apple AirPlay Settings](#)

You can use AirPlay to view content from your iPhone, iPad or Mac on the TV screen.

 This function may not be supported depending on the model or geographical area.

Restoring the TV to the factory settings

 >  [Settings](#) > [General](#) > [Reset](#) [Try Now](#)

You can restore all TV settings to the factory defaults.

1. Select [Reset](#). The security PIN entry window appears.
2. Enter the security PIN, and then select [Reset](#). All settings are then reset. The TV turns off and on again automatically and displays the Initial Setup screen.

 For more information on [Reset](#), refer to the user manual that came with the TV.

 If you skipped some steps in the initial setup, run [Set Up TV](#) ( >  [Source](#) > up directional button > [TV](#) > up directional button > [Set Up TV](#)), and then configure the settings in the steps you skipped.

Turning off in Portrait Mode

 >  [Settings](#) > [General](#) > [System Manager](#) > [Turn Off in Portrait](#)

When the TV is turned off, it switches to Portrait Mode and then the TV turns off.

 This function is supported only in The Sero.

Using the Outdoor Mode

 >  [Settings](#) > [General](#) > [System Manager](#) > [Outdoor Mode](#)

 This function is supported only in The Terrace and The Terrace for business.

 For more information on [Outdoor Mode](#), refer to the user manual that came with the TV.

HbbTV

Access services from entertainment providers, online providers and CE manufactures through HbbTV.

 This function may not be supported depending on the model or geographical area.

 Some channels may not include the HbbTV service.

In some countries, HbbTV is disabled by default. In this case, HbbTV can be used by installing the HbbTV application (the HbbTV Installer Application) in  > [Apps](#).

To set the HbbTV automatic start to on or off, access  > [Settings](#) > [Broadcasting](#) > [Expert Settings](#) > [HbbTV Settings](#) and set [HbbTV](#) to on or off. (Depending on the geographical area.)

You can use the following functions:



- [HbbTV](#): Enable or disable data services.
- [Do Not Track](#): Ask apps and services not to track your browsing activity.
- [Private Browsing](#): Enable Private Browsing to stop the browser from saving your Internet history.
- [Delete Browsing Data](#): Delete all saved Cookies.

If you want this function enabled or disabled, use the Select button to turn it on or off.

- HbbTV is not available when Timeshift is running or when a recorded video is being played back.
- An application on HbbTV may malfunction temporarily depending on the circumstances of the broadcast station or application provider.
- An application on HbbTV usually operates only when the TV is connected to an external network. The application may malfunction depending on the network conditions.
- When the HbbTV application is installed and the broadcasting programme supports HbbTV, a red button appears on the screen.
- It is possible to use both Digital Teletext mode and Traditional Teletext mode in several limited channels by pressing the TTX/MIX button on the remote control in a toggling manner.
- When you press the TTX/MIX button once in HbbTV mode, Digital Teletext mode of HbbTV is activated.
- When you press the TTX/MIX button twice in HbbTV mode, Traditional Teletext mode is activated.

Using a TV Viewing Card (“CI or CI+ Card”) (For India Only)

Watches paid channels by inserting your TV Viewing Card (“CI or CI+ Card”) into the COMMON INTERFACE slot.

-  The 2 CI card slots may not be supported depending on the model.
-  Turn the TV off to connect or disconnect a “CI or CI+ Card”.
-  The “CI or CI+ Card” may not supported depending on the model.

Connecting the “CI or CI+ Card” via COMMON INTERFACE slot with the CI CARD Adapter

-  Only for models with Common interface slot.

Attaching the CI CARD Adapter via COMMON INTERFACE slot

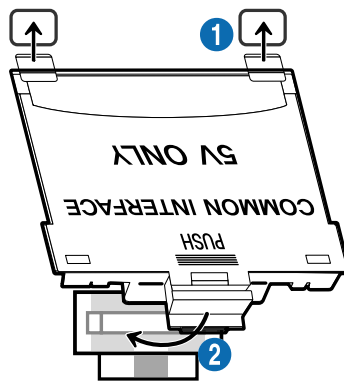

To attach the CI CARD Adapter to the TV, follow these steps:

- 1** Insert the CI CARD Adapter into the two holes on the back of TV.
 -  Please locate the two holes at the back of the TV above the COMMON INTERFACE slot.
- 2** Connect the CI CARD Adapter to the COMMON INTERFACE slot on the back of TV.

Connecting the “CI or CI+ Card”

Connect the “CI or CI+ Card” to the COMMON INTERFACE slot as shown in the image below.

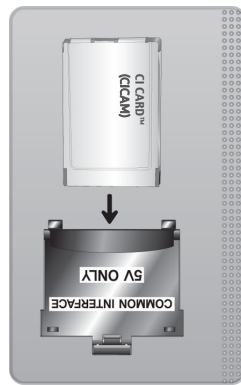

Connecting the “CI or CI+ Card” via COMMON INTERFACE slot

 Only for models with Common interface slot.

Connect the “CI or CI+ Card” to the COMMON INTERFACE slot as shown in the image below.

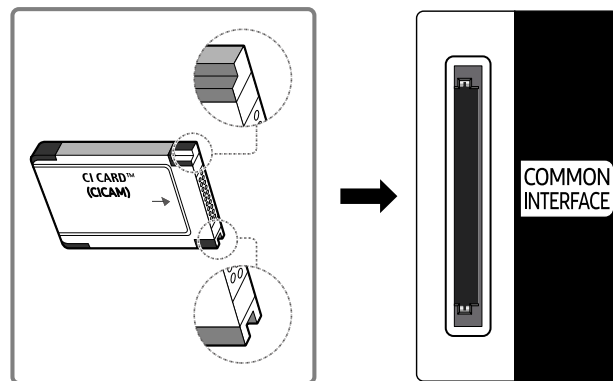

Using the “CI or CI+ Card”

To watch paid channels, the “CI or CI+ CARD” must be inserted.

- Samsung TV follow up CI+ 1.4 standard. When Samsung TV display the pop-up message, it may happen due to CI + 1.4 Version inconsistency. If you have a problem, please contact Samsung Call Centre.

 Your Samsung TV conforms to the CI+ 1.4 standards.

 Where a CI+ Common Interface module is incompatible with Samsung TV then please remove the module and contact the CI+ operator for assistance.

- If you don't insert the “CI or CI+ CARD”, some channels will display the pop-up message.
- The pairing information will be displayed in about 2-3 minutes. If an error message is displayed, please contact your service provider.
- When the configuration of channel information has finished, the message “Updating Completed” is displayed, indicating the channel list is updated.

 You must obtain a “CI or CI+ CARD” from a local cable service provider.

 When removing the “CI or CI+ CARD”, carefully pull it out with your hands since dropping the “CI or CI+ CARD” may cause damage to it.

 Insert the “CI or CI+ CARD” in the direction marked on the card.

 The location of the COMMON INTERFACE slot may be different depending on the model.

 “CI or CI+ CARD” is not supported in some countries and regions. Check with an authorised dealer to find out if “CI or CI+ CARD” is supported in your locality.

 If you have any problems, please contact a service provider.

 Insert the “CI or CI+ CARD” that supports the current aerial settings. If not, the screen may not look normal.

Teletext Feature

Learn how to use Teletext and run the functions provided by Teletext Service.

 This function is available only in the channel that supports the teletext service.

 This function may not be supported depending on the model or geographical area.

 To enter the Teletext feature,

On the Samsung Smart Remote: Press the  or  button, and then select TTX/MIX on the pop-up list.

On the standard remote control: Press the  TTX/MIX button.

 To exit from the Teletext feature,

On the Samsung Smart Remote: Press the TTX/MIX button on the pop-up list until a live TV programme appears.

On the standard remote control: Press the  TTX/MIX button on the remote control until live TV appears.

The index page of the Teletext service gives you information on how to use the Service. For Teletext information to be displayed correctly, channel reception must be stable. Otherwise, information may be missing or some pages may not be displayed.

 To change the Teletext page,

On the Samsung Smart Remote: Press the numeric button on the virtual numeric pad.











On the standard remote control: Press the numeric button.

On the Samsung Smart Remote

TTX/MIX (Full TTX / Double TTX / Mix / Live TV): The teletext mode is activated in the channel that is being watched. Each time you press the TTX/MIX button, the teletext mode changes in the order of **Full TTX** → **Double TTX** → **Mix** → **Live TV**.

- **Full TTX:** The teletext mode appears on the full screen.
- **Double TTX:** The teletext mode appears on the half screen along with the currently viewed channel on the other half.
- **Mix:** The teletext mode appears transparently on the currently viewed channel.
- **Live TV:** It returns to the live TV screen.

Colour buttons (red, green, yellow, blue): If the FASTEXT system is used by the broadcasting company, the different topics on a Teletext page are colour-coded and can be selected by coloured buttons. Press the colour corresponding to the topic of your choice. A new colour coded page appears. Items can be selected in the same way. To display the previous or next page, select corresponding coloured button.

-  **Index:** Displays the index (contents) page at any time while you are viewing Teletext.
-  **Sub Page:** Displays the available sub-page.
-  **List/Flof:** Selects the Teletext mode. If pressed during LIST mode, switches the mode to List save mode. In List save mode, you can save a Teletext page into a list using the  (Store) button.
-  **Store:** Stores the Teletext pages.
-  **Page Up:** Displays the next Teletext page.
-  **Page Down:** Displays the previous Teletext page.
-  **Reveal/Conceal:** Displays or hides the hidden text (answers to quiz games, for example). To display the normal screen, press it again.
-  **Size:** Displays the teletext on the upper half of the screen in double-size. To move the text to the lower half of the screen, press it again. For normal display, press it once again.
-  **Hold:** Holds the display at the current page, in the case that there are several secondary pages that follow automatically. To undo, press it again.
-  **Cancel:** Shrinks the Teletext display to overlap with the current broadcast. To undo, press it again.

On the standard remote control

 On the standard remote control, the Teletext function icons are printed on some remote control buttons. To run a Teletext function, find its icon printed on a remote control button, and then press the found button.

TTX/MIX

Full TTX / Double TTX / Mix / Live TV: The teletext mode is activated in the channel that is being watched. Each time you press the  TTX/MIX button, the teletext mode changes in the order of **Full TTX** → **Double TTX** → **Mix** → **Live TV**.

- **Full TTX:** The teletext mode appears on the full screen.
- **Double TTX:** The teletext mode appears on the half screen along with the currently viewed channel on the other half.
- **Mix:** The teletext mode appears transparently on the currently viewed channel.
- **Live TV:** It returns to the live TV screen.

Colour buttons (red, green, yellow, blue): If the FASTEXT system is used by the broadcasting company, the different topics on a Teletext page are colour-coded and can be selected by coloured buttons. Press the colour corresponding to the topic of your choice. A new colour coded page appears. Items can be selected in the same way. To display the previous or next page, select corresponding coloured button.

 SETTINGS

Index: Displays the index (contents) page at any time while you are viewing Teletext.

 PRE-CH

Sub Page: Displays the available sub-page.

 SOURCE

List/Flof: Selects the Teletext mode. If pressed during LIST mode, switches the mode to List save mode. In List save mode, you can save a Teletext page into a list using the  (CH LIST) button.

 CH LIST

Store: Stores the Teletext pages.

 CH ^

Page Up: Displays the next Teletext page.

 CH v

Page Down: Displays the previous Teletext page.

 INFO

Reveal/Conceal: Displays or hides the hidden text (answers to quiz games, for example). To display the normal screen, press it again.

AD/SUBT.

 Depending on the model or geographical area.

Size: Displays the teletext on the upper half of the screen in double-size. To move the text to the lower half of the screen, press it again. For normal display, press it once again.

RETURN

Hold: Holds the display at the current page, in the case that there are several secondary pages that follow automatically. To undo, press it again.

EXIT

Cancel: Shrinks the Teletext display to overlap with the current broadcast. To undo, press it again.

Typical Teletext page

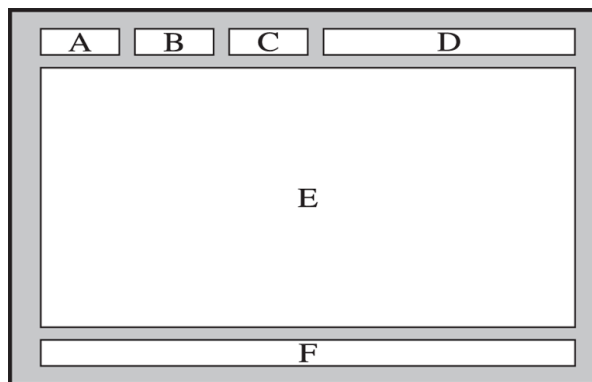

Part	Contents
A	Selected page number.
B	Broadcasting channel identity.
C	Current page number or search indications.
D	Date and time.
E	Text.
F	Status information. FASTEXT information.





Precautions and Notes

You can get instructions and information that you must read after installation.

Before Using the Recording and Timeshift Functions

Read these instructions before using Recording and Timeshift.

Before using the recording and schedule recording functions

-  Recording may not be supported depending on the model or geographical area.
- To set up a Schedule Recording, you must first set the TV's clock. Set the **Clock**.
 -  >  **Settings** > **General** > **System Manager** > **Time** > **Clock**
- You can set up a maximum total of 30 **Schedule Viewing** and **Schedule Recording** entries.
- Recordings are DRM-protected and therefore cannot be played back on a computer or on a different TV. In addition, these files cannot be played back on your TV if its video circuit has been replaced.
- For a USB device for recording, it is recommended to use the USB hard disk that supports USB 2.0 or later and 5,400 rpm or higher. However, RAID-type USB hard drives are not supported.
- USB memory sticks are not supported.
- The total recording capacity may differ with the amount of available hard drive space and the recording quality level.
- Schedule Recording** requires at least 100 MB of free space on the USB storage device. Recording will stop if the available storage space falls below 50 MB while recording is in progress.
- If the available storage space falls below 500 MB while both the Schedule Recording and Timeshift functions are in progress, only the recording will stop.
- The maximum recording time is 720 minutes.
- Videos are played according to the TV settings.
- If the input signal is changed while recording is in progress, the screen will go blank until the change is made. In this case, recording will resume, but  will not be available.
- When using the Record or Schedule Recording function, the actual recording may start a second or two later than the specified time.
- If the Schedule Recording function is operating while a recording is being made on an HDMI-CEC external device, the priority is given to the Schedule Recording.
- Connecting a recording device to the TV automatically deletes abnormally saved recorded files.

- If the [Sleep Timer](#) or [Auto Power Off](#) has been set, the TV will override these settings, continue to record and turn off after the recording has ended.

–  >  [Settings](#) > [General](#) > [System Manager](#) > [Time](#) > [Sleep Timer](#)

–  >  [Settings](#) > [General](#) > [Eco Solution](#) > [Auto Power Off](#)

Before using the timeshift function

 Timeshift may not be supported depending on the model or geographical area.

- For a USB device for recording, it is recommended to use the USB hard disk that supports USB 2.0 or later and 5,400 rpm or higher. However, RAID-type USB hard drives are not supported.
- USB memory sticks or flash drives are not supported.
- The total recording capacity may differ with the amount of available hard drive space and the recording quality level.
- If the available storage space falls below 500 MB while both the Schedule Recording and Timeshift functions are in progress, only the recording will stop.
- The maximum amount of time available for the Timeshift function is 90 minutes.
- The Timeshift function is not available for locked channels.
- Time-shifted videos are played according to the TV settings.
- The Timeshift function may be terminated automatically once it reaches its maximum capacity.
- The Timeshift function requires at least 1.5 GB of free space available on the USB storage device.

Supported broadcasting audio options

Check the supported broadcasting audio options.

	Audio Type	Dual Sound	Default
A2 Stereo	Mono	Mono	Automatic change
	Stereo	Stereo, Mono	Automatic change
	Dual	Dual I, Dual II	Dual I
NICAM Stereo	Mono	Mono	Automatic change
	Stereo	Mono, Stereo	Automatic change
	NICAM Dual	Mono, NICAM Dual-1, NICAM Dual-2	NICAM Dual-1

 If the [Stereo](#) signal is too weak and an automatic switching occurs, select [Mono](#).

 Available only for the stereo signals.

 Available only when the input source is set to [TV](#).

Read Before Using Apps

Read this information before using Apps.

- If you want to download new apps using [Apps](#), first sign in to your Samsung account.
- Due to the product characteristics featured on Samsung Smart Hub, as well as limitations in available content, certain features, applications and services may not be available on all devices or in all territories. Visit <http://www.samsung.com> for more information on specific device information and content availability. Services and content availability are subject to change without prior notice.
- Samsung Electronics takes no legal responsibility whatsoever for any interruption of app services caused by the service provider for any reason.
- Application services may be provided in English only and available content may differ with the geographical area.
- For more information about applications, visit the applicable service provider's website.
- An unstable Internet connection may cause delays or interruptions. In addition, applications may terminate automatically depending on the network environment. If this occurs, check your Internet connection and try again.
- Application services and updates may become unavailable.
- Application content is subject to change by the service provider without prior notice.
- Specific services may differ with the version of the application installed on the TV.
- An application's functionality may change in future versions of the application. If this occurs, run the application's tutorial or visit the service provider's website.
- Depending on the service provider's policies, certain applications may not support multitasking.



Read Before Using the Internet Function

Read this information before using the Internet function.

- File download is not supported.
- The **Internet** function may not be able to access certain websites, including websites operated by certain companies.
- The TV does not support playback of flash videos.
- E-commerce for online purchases is not supported.
- ActiveX is not supported.
- Only a limited number of fonts are supported. Certain symbols and characters may not be displayed properly.
- The response to remote commands and the resulting on-screen display may be delayed while a web page is loading.
- Loading a web page may be delayed or suspended completely depending on the status of the participating systems.
- Copy and paste operations are not supported.
- When composing an email or a simple message, certain functions such as the font size and colour selection may not be available.
- There is a limit to the number of bookmarks and the size of the log file that can be saved.
- The number of windows that can be opened concurrently is limited.
- Web browsing speed will differ with the network environment.
- Embedded videos in a web page cannot be played at the same time while the PIP (picture-in-picture) function is operating.
 -  This function may not be supported depending on the model or geographical area.
- Browsing history is saved from latest to oldest, with the oldest entries being overwritten first.
- Depending on the types of video/audio codecs supported, you may not be able to play certain HTML5 video and audio files.
- Video sources from PC-optimised streaming service providers may not play properly on our proprietary **Internet** browser.

Read before setting up a wireless Internet connection

Precautions for wireless Internet

- This TV supports the IEEE 802.11 a /b /g /n /ac communication protocols. Video files stored on a device connected to the TV via a Home Network may not play back smoothly.
 -  Q950T, Q900T series supports the IEEE 802.11 a /b /g /n /ac /ax communication protocols.
 -  For models other than the Q950T and Q900T series, Samsung recommends using IEEE 802.11n.
- To use wireless Internet, the TV must be connected to a wireless access point or modem. If the wireless access point supports DHCP, the TV can use a DHCP or static IP address to connect to the wireless network.
- Select a channel that is not currently being used by the wireless access point. If the channel set is currently being used by the wireless access point to communicate with another device, the result is usually interference and/or a communications failure.
- Most wireless networks have an optional security system. To enable a wireless network's security system, you need to create a password using characters and numbers. This password is then needed to connect to a security-enabled access point.

Wireless security protocols

The TV only supports the following wireless network security protocols. The TV cannot connect to non-certified wireless access point.



- Authentication Modes: WEP, WPAPSK, WPA2PSK
- Encryption Types: WEP, TKIP, AES

In compliance with the Wi-Fi certification specifications, Samsung TVs do not support WEP or TKIP security encryption in networks running in the 802.11n mode. If the wireless access point supports WPS (Wi-Fi Protected Setup), you can connect the TV to your network using PBC (Push Button Configuration) or a PIN (Personal Identification Number). WPS automatically configures the SSID and WPA key settings.

Read Before Playing Photo, Video or Music Files

Read this information before playing media content.

Limitations to the use of photo, video and music files Try Now

- The TV supports MSC (Mass Storage Class) USB devices only. MSC is a class designation for mass storage devices. Types of MSC devices include external hard drives, flash card readers and digital cameras. (USB hubs are not supported.) These kinds of devices must be connected directly to the USB port. The TV may not be able to recognise a USB device or read the files on the device if it is connected with a USB extension cable. Do not disconnect USB devices while they are transferring files.
- When connecting an external hard drive, use the USB (HDD 5V 1A) port. We recommend that you use an external hard drive with its own power adapter.
 -  USB (HDD 5V 0.5A) port is supported by some models.
- Certain digital cameras and audio devices may not be compatible with the TV.
- If there are multiple USB devices connected to the TV, the TV might not be able to recognise some or all the devices. USB devices that use high-power input should be connect to the USB (HDD 5V 1A) port.
 -  USB (HDD 5V 0.5A) port is supported by some models.
- The TV supports the FAT, exFAT and NTFS file systems.
- In the media contents list, the TV can display up to 1,000 files per folder. If the USB device contains more than 8,000 files and folders, however, some files and folders might not be accessible.
- Certain files, depending on how they are encoded, may not play on the TV.
- Certain files are not supported on all models.
- The DivX and DTS codecs are not supported by the Samsung TV models released in 2020.

Supported subtitles

Subtitle formats

Name	Format
MPEG-4 Timed text	.txt
SAMI	.smi
SubRip	.srt
SubViewer	.sub
Micro DVD	.sub or .txt
SubStation Alpha	.ssa
Advanced SubStation Alpha	.ass
SMPTE-TT Text	.xml

Video formats with subtitles

Name	Container
Xsub	AVI
SubStation Alpha	MKV
Advanced SubStation Alpha	MKV
SubRip	MKV
VobSub	MKV
MPEG-4 Timed text	MP4
TTML in smooth streaming	MP4
SMPTE-TT TEXT	MP4
SMPTE-TT PNG	MP4

Supported image formats and resolutions

File extension	Format	Resolution
*.jpg *.jpeg	JPEG	15360 x 9024
*.png	PNG	4096 x 4096
*.bmp	BMP	4096 x 4096
*.mpo	MPO	15360 x 8640

 The MPO format is supported partly.

Supported music formats and codecs

File extension	Format	Codec	Note
*.mp3	MPEG	MPEG1 Audio Layer 3	
*.m4a *.mpa *.aac	MPEG4	AAC	
*.flac	FLAC	FLAC	Supports up to 2 channels
*.ogg	OGG	Vorbis	Supports up to 2 channels
*.wma	WMA	WMA	WMA is supported up to 10 Pro 5.1 channels. WMA lossless audio is not supported.
*.wav	wav	wav	
*.mid *.midi	midi	midi	Supports type 0 and type 1. Seek is not supported. Supports USB device only.
*.ape	ape	ape	
*.aif *.aiff	AIFF	AIFF	
*.m4a	ALAC	ALAC	

Supported video codecs (QLED TV, The Serif, The Frame, The Sero, The Terrace, The Terrace for business)

 For Q60T model, refer to the next section.

File format	Container	Video codecs	Resolution	Frame rate (fps)	Bitrate (Mbps)	Audio codecs
*.avi		H.264 BP/MP/HP	4096 x 2160	4096 x 2160: 30	60	
*.mkv				3840 x 2160: 60		
*.asf						
*.wmv	AVI			4096 x 2160: 60		
*.mp4	MKV	HEVC (H.265 - Main, Main10)	4096 x 2160	3840 x 2160: 120	80	Dolby Digital LPCM
*.mov	ASF					ADPCM(IMA, MS)
*.3gp	MP4	Motion JPEG	3840 x 2160	30	80	AAC
*.vro	3GP	MVC				HE-AAC
*.mpg	MOV	MPEG4 SP/ASP				WMA
*.mpeg	FLV	Window Media Video v9 (VC1)		60		Dolby Digital+
*.ts	VRO	MPEG2				MPEG(MP3)
*.tp	VOB	MPEG1				AC-4
*.trp	PS	Microsoft MPEG-4 v1, v2, v3	1920 x 1080		20	G.711(A-Law, μ -Law)
*.flv	TS					OPUS
*.vob	SVAF	Window Media Video v7 (WMV1), v8 (WMV2)		30		
*.svi						
*.m2ts		H.263 Sorrenson				
*.mts		VP6				
		AV1	3840 x 2160	60	40	
		VP8	1920 x 1080	60	20	
*.webm	WebM	VP9 (Profile 0, profile 2 supported)	3840 x 2160	60	80	Vorbis
		AV1	3840 x 2160	60	40	
*.rmvb	RMVB	RV8/9/10 (RV30/40)	1920 x 1080	60	20	RealAudio 6

Supported video codecs (Q60T model, TU8 series)

File format	Container	Video codecs	Resolution	Frame rate (fps)	Bitrate (Mbps)	Audio codecs
*.avi	AVI MKV ASF MP4 3GP MOV FLV VRO VOB PS TS SVAF	H.264 BP/MP/HP	4096 x 2160	4096 x 2160:	60	Dolby Digital LPCM ADPCM(IMA, MS) AAC HE-AAC WMA Dolby Digital+ MPEG(MP3) AC-4 G.711(A-Law, μ -Law) OPUS
*.mkv				30		
*.asf		HEVC (H.265 - Main, Main10)	3840 x 2160	3840 x 2160:	80	
*.wmv				60		
*.mp4		Motion JPEG	3840 x 2160	30	80	
*.mov		MVC	1920 x 1080	60	20	
*.3gp		MPEG4 SP/ASP				
*.vro		Window Media Video v9 (VC1)				
*.mpg		MPEG2				
*.mpeg		MPEG1				
*.ts		Microsoft MPEG-4 v1, v2, v3				
*.tp		Window Media Video v7 (WMV1), v8 (WMV2)				
*.trp		H.263 Sorrenson				
*.flv		VP6				
*.vob	AV1	3840 x 2160				60
*.svi	WebM	VP8	1920 x 1080	60	20	
*.m2ts		VP9 (Profile 0, profile 2 supported)	3840 x 2160	60	80	
*.mts		AV1	3840 x 2160	60	40	
*.rmvb	RMVB	RV8/9/10 (RV30/40)	1920 x 1080	60	20	RealAudio 6

Other restrictions

- Codecs may not function properly if there is a problem with the content.
- Video content does not play or does not play correctly if there is an error in the content or container.
- Sound or video may not work if they have standard bit rates/frame rates above the TV's compatibility ratings.
- If the Index Table is has an error, the Seek (Jump) function will not work.
- When playing video over a network connection, the video may not play smoothly because of data transmission speeds.
- Some USB/digital camera devices may not be compatible with the TV.
- HEVC codec is only available in MKV / MP4 / TS containers.
- The MVC codec is supported partly.

Video decoders

- H.264 UHD is supported up to Level 5.1, and H.264 FHD is supported up to Level 4.2. (TV does not support FMO / ASO / RS)
- HEVC UHD is supported up to Level 5.2, and HEVC FHD is supported up to Level 4.1. (QLED TV, The Serif, The Frame, The Sero, The Terrace, The Terrace for business)
- HEVC UHD is supported up to Level 5.1, and HEVC FHD is supported up to Level 4.1. (Q60T model, TU8 series)
- VC1 AP L4 is not supported.
- GMC 2 or above is not supported.

Audio decoders

- WMA is supported up to 10 Pro 5.1 channels.
- WMA1, WMA lossless / Voice are not supported.
- QCELP and AMR NB/WB are not supported.
- Vorbis is supported for up to 5.1 channels.
- Dolby Digital+ is supported for up to 5.1 channels.
- The supported sample rates are 8, 11.025, 12, 16, 22.05, 24, 32, 44.1, and 48 KHz, and differ with the codec.

Supported video codecs (Q800T series or higher)

File format	Container	Video codecs	Resolution	Frame rate (fps)	Bitrate (Mbps)	Audio codecs
*.avi *.mkv *.asf	AVI	H.264 BP/MP/HP	4096 x 2160	4096 x 2160: 30	60	Dolby Digital LPCM ADPCM(IMA, MS) AAC HE-AAC WMA Dolby Digital+ MPEG(MP3) AC-4 G.711(A-Law, μ-Law) OPUS
*.wmv *.mp4 *.mov				3840 x 2160: 120		
*.3gp *.vro	MP4	Motion JPEG	3840 x 2160	30	80	
*.mpg	3GP	MVC	1920 x 1080	60	20	
*.mpeg	MOV	MPEG4 SP/ASP				
*.ts	FLV	Window Media Video v9 (VC1)				
*.tp	VRO	MPEG2				
*.trp	VOB	MPEG1				
*.flv	PS	Microsoft MPEG-4 v1, v2, v3				
*.vob	TS	Window Media Video v7 (WMV1), v8 (WMV2)				
*.svi	SVAF	H.263 Sorrenson				
*.m2ts *.mts		VP6				
		AV1				7680 x 4320
		VP8	1920 x 1080	60	20	
*.webm	WebM	VP9 (Profile 0, profile 2 supported)	3840 x 2160	60	80	Vorbis
		AV1	7680 x 4320	60	60	
*.rmvb	RMVB	RV8/9/10 (RV30/40)	1920 x 1080	60	20	RealAudio 6

 Because the specifications are based on the current 8K connectivity and decoding standards, future connectivity, broadcasting, and decoding standards may not be supported. Upgrading for meeting future standards may require purchase of additional devices.

 Some 3rd party standards may not be supported.

Other restrictions

- Codecs may not function properly if there is a problem with the content.
- Video content does not play or does not play correctly if there is an error in the content or container.
- Sound or video may not work if they have standard bit rates/frame rates above the TV's compatibility ratings.
- If the Index Table is has an error, the Seek (Jump) function will not work.
- When playing video over a network connection, the video may not play smoothly because of data transmission speeds.
- Some USB/digital camera devices may not be compatible with the TV.
- HEVC codec is only available in MKV / MP4 / TS containers.
- The MVC codec is supported partly.

Video decoders

- H.264 UHD is supported up to Level 5.1, and H.264 FHD is supported up to Level 4.2. (TV does not support FMO / ASO / RS)
- HEVC UHD is supported up to Level 5.2, and HEVC FHD is supported up to Level 4.1.
- HEVC 8K is supported up to Level 6.1.
- AV1 8K is supported up to Level 6.1.
- VC1 AP L4 is not supported.
- GMC 2 or above is not supported.

Audio decoders

- WMA is supported up to 10 Pro 5.1 channels.
- WMA1, WMA lossless / Voice are not supported.
- QCELP and AMR NB/WB are not supported.
- Vorbis is supported for up to 5.1 channels.
- Dolby Digital+ is supported for up to 5.1 channels.
- The supported sample rates are 8, 11.025, 12, 16, 22.05, 24, 32, 44.1, and 48 KHz, and differ with the codec.

Read After Installing the TV

Read this information after installing the TV.

Picture sizes and input signals

The **Picture Size** is applied to the current source. The applied **Picture Size** will remain in effect whenever you select that source unless you change them.

Input signal	Picture size
Component	16:9 Standard, Custom, 4:3
Digital channel (720p)	16:9 Standard, Custom, 4:3
Digital channel (1080i, 1080p)	16:9 Standard, Custom, 4:3
Digital channel (3840 x 2160p @ 24/30 Hz)	16:9 Standard, Custom
Digital channel (3840 x 2160p @ 50/60 Hz)	16:9 Standard, Custom
Digital channel (4096 x 2160p)	16:9 Standard, Custom
HDMI (720p)	16:9 Standard, Custom, 4:3
HDMI (1080i, 1080p)	16:9 Standard, Custom, 4:3
HDMI (3840 x 2160p)	16:9 Standard, Custom
HDMI (4096 x 2160p)	16:9 Standard, Custom
*HDMI (7680 x 4320p)	16:9 Standard, Custom
USB (720p)	16:9 Standard, Custom, 4:3
USB (1080i/p @ 60 Hz)	16:9 Standard, Custom, 4:3
USB (3840 x 2160p @ 24/30 Hz)	16:9 Standard, Custom
USB (3840 x 2160p @ 60 Hz) USB (4096 x 2160p @ 24/30/60 Hz)	16:9 Standard, Custom
*USB (7680 x 4320p @ 24/30/60 Hz)	16:9 Standard, Custom

 *: This input signal is supported by Q800T series or higher.

 The input ports for external devices may differ depending on the model and geographical area.

Installing an anti-theft lock

An anti-theft lock is a physical device that can be used to protect the TV against theft. Look for the lock slot on the back of the TV. The slot has a  icon next to it. To use the lock, wrap the lock cable around an object that is too heavy to carry and then thread it through the TV's lock slot. The lock is sold separately. The method of using an anti-theft lock may differ for each model. Refer to the lock's user manual for more information.

 This function may not be supported depending on the model or geographical area.

Supported Resolutions for UHD Input Signals

Check the supported resolution for UHD input signals.

- Resolution: 3840 x 2160p, 4096 x 2160p

If Input Signal Plus is set to Off

Frame rate (fps)	Colour Depth / Chroma Sampling	RGB 4:4:4	YCbCr 4:4:4	YCbCr 4:2:2	YCbCr 4:2:0
50 / 60	8 bit	-	-	-	0

If Input Signal Plus is set to On

- All models for TU Series and Q60T model
- For less than 55-inch models (Q80T model, The Sero, The Serif, The Frame):

Frame rate (fps)	Colour Depth / Chroma Sampling	RGB 4:4:4	YCbCr 4:4:4	YCbCr 4:2:2	YCbCr 4:2:0
50 / 60	8 bit	0	0	0	0
	10 bit	-	-	0	0

- For 55-inch or larger models (QLED TV except for Q60T model, The Serif, The Frame, The Terrace, The Terrace for business):

Frame rate (fps)	Colour Depth / Chroma Sampling	RGB 4:4:4	YCbCr 4:4:4	YCbCr 4:2:2	YCbCr 4:2:0
50 / 60	8 bit	0	0	0	0
	10 bit	*0	*0	0	0
120	8 bit	*0	*0	*0	*0
	10 bit	*0	*0	*0	*0

 *: These specifications are supported for the HDMI 4 port.

Resolutions for Input Signals supported by Q800T series or higher

Check the resolutions for input signals supported by Q800T series or higher.

- Resolution: 3840 x 2160p, 4096 x 2160p

Frame rate (fps)	Colour Depth / Chroma Sampling	RGB 4:4:4	YCbCr 4:4:4	YCbCr 4:2:2	YCbCr 4:2:0
50 / 60	8 bit	0	0	0	0
	10 bit	*0	*0	0	0
120	8 bit	*0	*0	*0	*0
	10 bit	*0	*0	*0	*0

 *: These specifications are supported for the HDMI 4 port.

- Resolution: 7680 x 4320p

Frame rate (fps)	Colour Depth / Chroma Sampling	RGB 4:4:4	YCbCr 4:4:4	YCbCr 4:2:2	YCbCr 4:2:0
24 / 30 / 50 / 60	8 bit	0	0	0	0
	10 bit	0	0	0	0

 These specifications are supported for the HDMI 4 port.

Supported Resolutions for FreeSync(VRR)

[Check the supported resolutions for the FreeSync\(VRR\) signal.](#)

- When **Game Mode** is set to **On** or **Auto**, the FreeSync(VRR) function is activated.
- FreeSync(VRR) is supported only in the following models:

For 55-inch or larger models (QLED TV except for Q60T model, The Serif, The Frame, The Terrace, The Terrace for business)

 This function may not be supported depending on the model.

Resolution (Dots x lines)	Display format	Horizontal frequency (KHz)	Vertical frequency (Hz)	Clock frequency (MHz)	SCAN
1920 x 1080	120 Hz	135.000	120.000	297.000	progressive
2560 x 1440	120 Hz	150.000	120.000	495.000	progressive
3840 x 2160	60 Hz	135.000	60.000	594.000	progressive
4096 x 2160	60 Hz	135.000	60.000	594.000	progressive

Read Before Connecting a Computer (Supported Resolutions)

Check the resolutions supported for PC input signals.

When you connect your TV to a computer, set the computer's video card to one of the standard resolutions listed in the tables below or on the next pages. The TV will automatically adjust to the resolution you choose. Note that the optimal and recommended resolutions are 3840 x 2160 @ 60Hz (UHD models) and 7680 x 4320 @ 60Hz (Q800 series or higher). Choosing a resolution not included in the tables can result in a blank screen or just the remote control sensor turning on. Refer to the user manual of your graphics card for compatible resolutions.

 The native resolutions are 3840 x 2160 @ 60Hz (UHD models) and 7680 x 4320 @ 60Hz (Q800 series or higher) with the **Input Signal Plus** set to **On**. The native resolution is 3840 x 2160 at 30 Hz with the **Input Signal Plus** set to **Off**.

IBM

Resolution (Dots x lines)	Display format	Horizontal frequency (KHz)	Vertical frequency (Hz)	Clock frequency (MHz)	Polarity (horizontal / vertical)
720 x 400	70 Hz	31.469	70.087	28.322	- / +

MAC

Resolution (Dots x lines)	Display format	Horizontal frequency (KHz)	Vertical frequency (Hz)	Clock frequency (MHz)	Polarity (horizontal / vertical)
640 x 480	67 Hz	35.000	66.667	30.240	- / -
832 x 624	75 Hz	49.726	74.551	57.284	- / -
1152 x 870	75 Hz	68.681	75.062	100.000	- / -

VESA DMT

Resolution (Dots x lines)	Display format	Horizontal frequency (KHz)	Vertical frequency (Hz)	Clock frequency (MHz)	Polarity (horizontal / vertical)
640 x 480	60 Hz	31.469	59.940	25.175	- / -
640 x 480	72 Hz	37.861	72.809	31.500	- / -
640 x 480	75 Hz	37.500	75.000	31.500	- / -
800 x 600	60 Hz	37.879	60.317	40.000	+ / +
800 x 600	72 Hz	48.077	72.188	50.000	+ / +
800 x 600	75 Hz	46.875	75.000	49.500	+ / +
1024 x 768	60 Hz	48.363	60.004	65.000	- / -
1024 x 768	70 Hz	56.476	70.069	75.000	- / -
1024 x 768	75 Hz	60.023	75.029	78.750	+ / +
1152 x 864	75 Hz	67.500	75.000	108.000	+ / +
1280 x 720	60 Hz	45.000	60.000	74.250	+ / +
1280 x 800	60 Hz	49.702	59.810	83.500	- / +
1280 x 1024	60 Hz	63.981	60.020	108.000	+ / +
1280 x 1024	75 Hz	79.976	75.025	135.000	+ / +
1440 x 900	60 Hz	55.935	59.887	106.500	- / +
1600 x 900	60 Hz	60.000	60.000	108.000	+ / +
1680 x 1050	60 Hz	65.290	59.954	146.250	- / +
1920 x 1080	60 Hz	67.500	60.000	148.500	+ / +

VESA CVT

Resolution (Dots x lines)	Display format	Horizontal frequency (KHz)	Vertical frequency (Hz)	Clock frequency (MHz)	Polarity (horizontal / vertical)
*2560 x 1440	60 Hz	88.787	59.951	241.500	+ / -
2560 x 1440	120 Hz	192.996	119.998	497.750	+ / -

 The resolution may not be supported depending on the model.

 *: The HDMI 4 port does not support the resolution of 2560 x 1440 @ 60 Hz in **Game Mode** with Q800T series models or higher.

To use the resolution of 2560 x 1440 @ 60 Hz in **Game Mode**, it is recommended to use the HDMI 1/2/3 port.

CTA-861

Resolution (Dots x lines)	Display format	Horizontal frequency (KHz)	Vertical frequency (Hz)	Clock frequency (MHz)	Polarity (horizontal / vertical)
*1920 x 1080	100 Hz	112.500	100.000	297.000	+ / +
*1920 x 1080	120 Hz	135.000	120.003	297.000	+ / +
3840 x 2160	30 Hz	67.500	30.000	297.000	- / -
*3840 x 2160	60 Hz	135.000	60.000	594.000	- / -
*3840 x 2160	100 Hz	225.000	100.000	1188.000	+ / +
*3840 x 2160	120 Hz	270.000	120.000	1188.000	+ / +
4096 x 2160	24 Hz	54.000	24.000	297.000	+ / +
4096 x 2160	25 Hz	56.250	25.000	297.000	+ / +
4096 x 2160	30 Hz	67.500	30.000	297.000	+ / +
*4096 x 2160	50 Hz	112.500	50.000	594.000	+ / +
*4096 x 2160	60 Hz	135.000	60.000	594.000	+ / +
*4096 x 2160	100 Hz	225.000	100.000	1188.000	+ / +
*4096 x 2160	120 Hz	270.000	120.000	1188.000	+ / +
*7680 x 4320	24 Hz	108.000	24.000	1188.000	+ / +
*7680 x 4320	30 Hz	132.000	30.000	1188.000	+ / +
*7680 x 4320	50 Hz	220.000	50.000	2376.000	+ / +
*7680 x 4320	60 Hz	264.000	60.000	2376.000	+ / +

 *: The resolution may not be supported depending on the model.

Supported Resolutions for Video Signals

Check the resolutions supported for video signals.

CTA-861

Resolution (Dots x lines)	Display format	Horizontal frequency (KHz)	Vertical frequency (Hz)	Clock frequency (MHz)	Polarity (horizontal / vertical)
720 (1440) x 576i	50 Hz	15.625	50.000	27.000	- / -
720 (1440) x 480i	60 Hz	15.734	59.940	27.000	- / -
720 x 576	50 Hz	31.250	50.000	27.000	- / -
720 x 480	60 Hz	31.469	59.940	27.000	- / -
1280 x 720	50 Hz	37.500	50.000	74.250	+ / +
1280 x 720	60 Hz	45.000	60.000	74.250	+ / +
1920 x 1080i	50 Hz	28.125	50.000	74.250	+ / +
1920 x 1080i	60 Hz	33.750	60.000	74.250	+ / +
1920 x 1080	24 Hz	27.000	24.000	74.250	+ / +
1920 x 1080	25 Hz	28.125	25.000	74.250	+ / +
1920 x 1080	30 Hz	33.750	30.000	74.250	+ / +
1920 x 1080	50 Hz	56.250	50.000	148.500	+ / +
*1920 x 1080	100 Hz	112.500	100.000	297.000	+ / +
*1920 x 1080	120 Hz	135.000	120.003	297.000	+ / +
1920 x 1080	60 Hz	67.500	60.000	148.500	+ / +
3840 x 2160	24 Hz	54.000	24.000	297.000	+ / +
3840 x 2160	25 Hz	56.250	25.000	297.000	+ / +
3840 x 2160	30 Hz	67.500	30.000	297.000	+ / +
*3840 x 2160	50 Hz	112.500	50.000	594.000	+ / +
*3840 x 2160	60 Hz	135.000	60.000	594.000	+ / +
*3840 x 2160	100 Hz	225.000	100.000	1188.000	+ / +
*3840 x 2160	120 Hz	270.000	120.000	1188.000	+ / +

Resolution (Dots x lines)	Display format	Horizontal frequency (KHz)	Vertical frequency (Hz)	Clock frequency (MHz)	Polarity (horizontal / vertical)
4096 x 2160	24 Hz	54.000	24.000	297.000	+ / +
4096 x 2160	25 Hz	56.250	25.000	297.000	+ / +
4096 x 2160	30 Hz	67.500	30.000	297.000	+ / +
*4096 x 2160	50 Hz	112.500	50.000	594.000	+ / +
*4096 x 2160	60 Hz	135.000	60.000	594.000	+ / +
*4096 x 2160	100 Hz	225.000	100.000	1188.000	+ / +
*4096 x 2160	120 Hz	270.000	120.000	1188.000	+ / +
*7680 x 4320	24 Hz	108.000	24.000	1188.000	+ / +
*7680 x 4320	30 Hz	132.000	30.000	1188.000	+ / +
*7680 x 4320	50 Hz	220.000	50.000	2376.000	+ / +
*7680 x 4320	60 Hz	264.000	60.000	2376.000	+ / +

 *: The resolution may not be supported depending on the model.

VESA CVT

Resolution (Dots x lines)	Display format	Horizontal frequency (KHz)	Vertical frequency (Hz)	Clock frequency (MHz)	Polarity (horizontal / vertical)
2560 x 1440	60 Hz	88.787	59.951	241.500	+ / -
2560 x 1440	120 Hz	192.996	119.998	497.750	+ / -

 The resolution may not be supported depending on the model.

Supported Resolutions for HDBT

[Check the resolutions supported for HDBT.](#)

 HDBT is used only for The Terrace, The Terrace for business.

CEA-861

Resolution (Dots x lines)	Display format	Horizontal frequency (KHz)	Vertical frequency (Hz)	Clock frequency (MHz)
640 x 480	60 Hz	31.469	60.000	25.000
720 x 480	60 Hz	31.469	60.000	27.000
720 x 576	50 Hz	31.250	50.000	27.000
1280 x 720	50 Hz	37.500	50.000	74.000
1280 x 720	60 Hz	45.000	60.000	74.000
1440 x 480	60 Hz	15.734	60.000	27.000
1440 x 576	50 Hz	15.625	50.000	27.000
1440 x 576	50 Hz	31.250	50.000	54.000
1920 x 1080	24 Hz	27.000	24.000	74.000
1920 x 1080	25 Hz	28.125	25.000	74.000
1920 x 1080	30 Hz	33.750	30.000	74.000
1920 x 1080	50 Hz	31.250	50.000	72.000
1920 x 1080	50 Hz	33.750	30.000	74.000
1920 x 1080	50 Hz	56.250	50.000	149.000
1920 x 1080	60 Hz	33.750	60.000	74.000
1920 x 1080	60 Hz	67.500	60.000	149.000
1920 x 1080	100 Hz	112.500	100.000	297.000
1920 x 1080	120 Hz	135.000	120.000	297.000
3840 x 2160	30 Hz	67.500	30.000	297.000

Read Before Using Bluetooth Devices





Read this information before using a Bluetooth device.

 This function may not be supported depending on the model or geographical area.

Restrictions on using Bluetooth

- You can't use Bluetooth devices and the [Wi-Fi Speaker Surround Setup](#) feature simultaneously.
- Compatibility issues may occur, depending on the Bluetooth device. (A Mobile exclusive headphone may not be available, depending on the environment.)
- Lip-sync errors may occur.
- The TV and Bluetooth device may disconnect, depending on the distance between them.
- A Bluetooth device may hum or malfunction:
 - When a part of your body is in contact with the receiving/transmitting system of the Bluetooth device or the TV.
 - When the device is subject to electrical variation from obstructions caused by a wall, corner or office partitioning.
 - When the device is exposed to electrical interference from same frequency-band devices including medical equipment, microwave ovens and wireless LANs.
- If the problem persists, we recommend you use a wired connection.
 - DIGITAL AUDIO OUT (OPTICAL) port
 - HDMI (eARC) port

Suffix : Parental Rating - Thailand only

Alphabet	Icon	Description
Allow All		The broadcasted rating value is not classified
Preschool		Content suitable for preschool aged children 3-5 years old
Children		Content suitable for children between 6–12 years old
General		Content suitable for general audiences
PG 13 (PG-13)		Content suitable for people aged 13 and above, but can be watched by those who are under the recommended age if parental guidance is provided
PG 18 (PG-18)		Content suitable for people aged 18 and above, but can be watched by those who are under the recommended age if parental guidance is provided
Adults		Content unsuitable for children and youngsters

Licences

[Check the licence information and trademarks applied in your TV.](#)

DOLBY AUDIO™

Manufactured under license from Dolby Laboratories. Dolby, Dolby Audio, Pro Logic, and the double-D symbol are trademarks of Dolby Laboratories.



The terms HDMI and HDMI High-Definition Multimedia Interface, and the HDMI Logo are trademarks or registered trademarks of HDMI Licensing LLC in the United States and other countries.

Open Source License Notice

Open Source used in this product can be found on the following webpage. (<http://opensource.samsung.com>)



POWERED BY



 This licence may not be supported depending on the model or geographical area.

Troubleshooting

If you have a problem with your TV, you can access various solutions while watching TV. If your problem is not addressed in the Troubleshooting section, view the FAQ section or contact the Samsung Call Centre.















Picture Issues























When the TV has trouble with the picture, these steps may help resolve the problem.



















Testing the picture





 >  [Settings](#) > [Support](#) > [Device Care](#) > [Self Diagnosis](#) > [Picture Test](#) Try Now

Before you review the list of problems and solutions below, use [Picture Test](#) to determine if the problem is caused by the TV. [Picture Test](#) displays a high definition picture you can examine for flaws or faults.

The problem	Try this!
<p>Flickering and Dimming</p>	<p>If your TV is flickering or dimming sporadically, you may need to disable some of the energy efficiency features.</p> <p>Disable Ambient Light Detection, Energy Saving Mode, Motion Lighting or Contrast Enhancer.</p> <ul style="list-style-type: none"> •  >  Settings > General > Eco Solution > Ambient Light Detection •  >  Settings > General > Eco Solution > Energy Saving Mode •  >  Settings > General > Eco Solution > Motion Lighting •  >  Settings > Picture > Expert Settings > Contrast Enhancer <p>Run Picture Test. When the tested image quality is normal, check the signal of the connected device.</p> <ul style="list-style-type: none"> •  >  Settings > Support > Device Care > Self Diagnosis > Picture Test
<p>Component Connections and Screen Colour</p>	<p>If the colour on your TV screen is not correct or the black and white colours are off, run Picture Test.</p> <ul style="list-style-type: none"> •  >  Settings > Support > Device Care > Self Diagnosis > Picture Test <p>If the test results indicate that the problem is not caused by the TV, do the following:</p> <p>When using the One Connect, confirm that its video input connectors are connected to the correct external device video output connectors.</p> <p>When using the component cable, confirm that the green (Y), blue (Pb) and red (Pr) jacks are plugged into their proper connectors.</p> <p>For more information about how to connect an external device, run Connection Guide.</p> <ul style="list-style-type: none"> •  >  Source > Connection Guide

The problem	Try this!
Screen Brightness	<p>If the colours on your TV are correct but just a little too dark or bright, try adjusting the following settings first.</p> <ul style="list-style-type: none"> •  >  Settings > Picture > Expert Settings > Contrast •  >  Settings > Picture > Expert Settings > Brightness •  >  Settings > Picture > Expert Settings > Sharpness •  >  Settings > Picture > Expert Settings > Colour •  >  Settings > Picture > Expert Settings > Tint (G/R)
Blurring or Juddering	<p>If you notice blurring or juddering on the screen, use the Picture Clarity Settings function to resolve the issue.</p> <ul style="list-style-type: none"> •  >  Settings > Picture > Expert Settings > Picture Clarity Settings
Unwanted Powering Off	<p>If your TV appears to turn off by itself, try disabling some of the TV's energy efficiency functions.</p> <p>See if Sleep Timer has been enabled. The Sleep Timer automatically turns the TV off after a specified period of time.</p> <ul style="list-style-type: none"> •  >  Settings > General > System Manager > Time > Sleep Timer <p>If the Sleep Timer has not been enabled, see if Auto Power Off or Off Timer has been enabled and disable it.</p> <ul style="list-style-type: none"> •  >  Settings > General > Eco Solution > Auto Power Off •  >  Settings > General > System Manager > Time > Off Timer <p>In case of The Sero, check the options such as The Sero Auto On/Off and Off Timer in the SmartThings app on your mobile device. The Sero Auto On/Off is intended to automatically turn on The Sero when your mobile device approaches and to automatically turn off it after a specific time when your mobile device gets far away from it.</p>
Problems Powering On	<p>If you are having problems powering on your TV, there are a number of things to check before calling the service department.</p> <p>Confirm that the TV's power cable is connected correctly at both ends and that the remote control is operating normally.</p> <p>Make sure that the antenna cable or cable TV cable is firmly connected.</p> <p>If you have a cable box or satellite box, confirm that it is plugged in and turned on.</p> <p>In case of a model that supports One Connect, check the One Invisible Connection between the TV and One Connect.</p>
Unable to find a Channel	<p>If your TV is not connected to a cable box or satellite box, run Auto Tuning.</p> <ul style="list-style-type: none"> •  >  Settings > Broadcasting > (Auto Tuning Settings) > Auto Tuning <p> The Auto Tuning Settings may not appear depending on the model or geographical area.</p> <p>When using a broadcast receiver such as set-top box and IPTV, check the connection to the TV.</p> <ul style="list-style-type: none"> •  >  Source > Connection Guide <p>When the symptom persists, contact your service provider.</p>

The problem	Try this!
<p>The TV image does not look as good as it did in the store.</p>	<p>Store displays are tuned to a digital UHD channel or HD channel.</p> <p>Change the output resolution of your devices such as digital broadcast receiver, IPTV and set-top box to UHD or HD.</p> <p>Be sure to use an HDMI cable to enjoy high quality videos.</p> <ul style="list-style-type: none"> •  >  Source > Connection Guide > Video Device > HDMI <p>To connect the TV with your PC, make sure that your PC's graphic card supports UHD resolutions.</p> <p>For more information about the supported UHD resolutions, refer to "Supported Resolutions for UHD Input Signals".</p> <p> Make sure that the set-top box or cable box supports the content or broadcast for UHD and set the resolution. For more information, contact your service provider.</p> <p> When using a Samsung TV Plus channel, check the network connection. When the network speed is slow, the app may not work or the image quality may be poor.</p>
<p>The picture is distorted.</p>	<p>The compression of video content may cause picture distortions, especially in fast moving pictures from sports programmes and action movies.</p> <p>If the signal reception is weak or poor, screen distortion may be visible but it is not a malfunction.</p> <p>Mobile phones used close to the TV (within 1 m) may cause noise on analogue and digital channels.</p>
<p>The colour is wrong or missing.</p>	<p>If you're using a Component connection, make sure that the Component cables are connected to the correct jacks.</p> <p>Incorrect or loose connections may cause colour problems or a blank screen.</p>
<p>The colour is poor or the picture is not bright enough.</p>	<p>Go to Picture and then adjust the Picture Mode, Brightness, Sharpness and Colour settings.</p> <ul style="list-style-type: none"> •  >  Settings > Picture > Picture Mode •  >  Settings > Picture > Expert Settings > Brightness •  >  Settings > Picture > Expert Settings > Sharpness •  >  Settings > Picture > Expert Settings > Colour <p>See if Energy Saving Mode has been enabled.</p> <ul style="list-style-type: none"> •  >  Settings > General > Eco Solution > Energy Saving Mode <p>Try resetting the picture.</p> <ul style="list-style-type: none"> •  >  Settings > Picture > Expert Settings > Reset Picture
<p>There is a dotted line on the edge of the screen.</p>	<p>Change Picture Size Settings to 16:9 Standard.</p> <ul style="list-style-type: none"> •  >  Settings > Picture > Picture Size Settings > Picture Size 16:9 Standard

The problem	Try this!
<p>The picture is black and white.</p>	<p>Use a composite cable when you connect AV equipment to the TV.</p> <p>If you are using the composite cable, connect the video cable (Yellow) to the VIDEO (Yellow / Green) input port.</p> <p> The COMPONENT IN port may not be supported depending on the model or geographical area.</p> <p>Check whether Greyscale is set to On.</p> <ul style="list-style-type: none"> •  > Settings > General > Accessibility > Greyscale
<p>The picture won't display in full screen.</p>	<p>HD channels will have black bars on either side of the screen when displaying upscaled SD (4:3) content.</p> <p>Black bars will appear at the top and bottom of the screen when you watch movies that have aspect ratios different from your TV.</p> <p>Adjust the picture size options on your external device or set the TV to full screen.</p> <ul style="list-style-type: none"> •  > Settings > Picture > Picture Size Settings > Picture Size
<p>The Subtitle function in the TV menu is deactivated.</p>	<p>When an external device is connected with an HDMI or Component cable, the Subtitle function is unavailable. Adjust the subtitle setting on the external device.</p>
<p>Subtitles appear on the TV screen.</p>	<p>Turn off the Subtitle function in Subtitle Settings.</p> <ul style="list-style-type: none"> •  > Settings > General > Accessibility > Subtitle Settings > Subtitle
<p>The HDR of the connected external device turns off.</p>	<p>Expand the reception range of the corresponding HDMI input signal in Input Signal Plus.</p> <ul style="list-style-type: none"> •  > Settings > General > External Device Manager > Input Signal Plus

 If the test picture does not appear or there is noise or distortion, the TV may have a problem. Contact Samsung's Call Centre for assistance.

 If the test picture is displayed properly, there may be a problem with an external device. Please check the connections.

 If the problem persists, check the [Signal Information](#) or refer to the external device's user manual.







Sound and Noise Issues

When the TV has difficulties with sound, these steps may help resolve the problem.

Testing the sound

 >  [Settings](#) > [Support](#) > [Device Care](#) > [Self Diagnosis](#) > [Sound Test](#) Try Now

If the TV plays the [Sound Test](#) melody without distortion, there may be a problem with an external device or the broadcast signal's strength.









The problem	Try this!
<p>How can I connect an audio device to the TV?</p>	<p>The connection method may differ depending on the audio device such as HDMI (eARC), Optical, Bluetooth and Wi-Fi.</p> <p>For more information about how to connect an audio device, run Connection Guide.</p> <ul style="list-style-type: none">  >  Source > Connection Guide > Audio Device
<p>There is no sound or the sound is too low at maximum volume.</p>	<p>Check the volume control of your TV, and then check the volume control of the external device (cable box or satellite box, DVD, Blu-ray, etc.) connected to your TV.</p> <p>Check the cable connection between an external device and the TV, and then try cable connection again.</p>
<p>The picture is good but there is no sound.</p>	<p>Set Sound Output to TV Speaker.</p> <ul style="list-style-type: none">  >  Settings > Sound > Sound Output <p>If you are using an external device, check the device's audio output option.</p> <p>For example, you may need to change your cable box's audio option to HDMI if the box connected to your TV is using an HDMI cable.</p> <p>To listen to computer sound, connect an external speaker to the computer's audio output connector.</p> <p>If your TV has a headphone jack, make sure there is nothing plugged into it.</p> <p>Reboot the connected device by disconnecting and then reconnecting the device's power cable.</p> <p>With a set-top box or cable box, check the cable connection and reboot the external device. When the symptom persists, contact your service provider.</p>
<p>No sound is heard.</p>	<p>Check whether Digital Output Audio Format is set to Pass-through.</p> <p>If you select the Pass-through option to use an AV receiver that does not support Dolby Digital+, no sound is output with Dolby Digital+ content.</p> <p>It is recommended to set Digital Output Audio Format to Auto when the connected receiver supports only the limited audio formats.</p> <ul style="list-style-type: none">  >  Settings > Sound > Expert Settings > Digital Output Audio Format > Auto

The problem	Try this!
<p>The speakers are making an odd sound.</p>	<p>Run Sound Test.</p> <ul style="list-style-type: none"> • Home > Settings > Support > Device Care > Self Diagnosis > Sound Test <p>Make sure that the audio cable is connected to the correct audio output connector on the external device.</p> <p>For antenna or cable connections, check the Signal Information. A low signal level may cause sound distortions.</p> <ul style="list-style-type: none"> • Home > Settings > Support > Device Care > Self Diagnosis > Signal Information
<p>The sound is interrupted.</p>	<p>The sound may frequently be interrupted when a Bluetooth speaker is used. Make sure that the Bluetooth speaker and the wireless access point are on a straight line and the Bluetooth speaker is placed as close as possible to the TV.</p> <p>To minimise interruptions, we recommend a wireless access point that uses a 5 GHz frequency.</p> <p>When the symptom persists, it is recommended to use wired connection such as HDMI (eARC) and Optical.</p>
<p>Whenever a function is used on the TV or the channel is changed, the TV voices the activity.</p> <p>The TV explains in voice-over the video scenes displayed on the screen.</p>	<p>Turn off the Voice Guide function in Voice Guide Settings.</p> <ul style="list-style-type: none"> • Home > Settings > General > Accessibility > Voice Guide Settings > Voice Guide
<p>The TV audio is not being played through the AV receiver.</p>	<p>Check the A/V receiver's power supply and its settings.</p> <ul style="list-style-type: none"> • When connecting the optical cable between the TV and A/V receiver, make sure that the sound output is set Optical on your TV. • In case of HDMI-eARC connection, make sure that it is connected to the eARC dedicated HDMI port on your TV. However, the eARC can be used only when the A/V receiver supports the eARC feature.

The problem	Try this!
<p>The sound is not heard clearly.</p>	<p>Change to an appropriate sound mode.</p> <ul style="list-style-type: none"> • 🏠 > ⚙️ Settings > Sound > Sound Mode <p>When Intelligent Mode and Adaptive Sound+ are turned on, the sound effects are automatically adjusted to the surroundings.</p> <ul style="list-style-type: none"> • 🏠 > ⚙️ Settings > General > Intelligent Mode Settings > Intelligent Mode <p>To optimise the sound depending on the surroundings, select Adaptive Sound+.</p> <ul style="list-style-type: none"> • 🏠 > ⚙️ Settings > General > Intelligent Mode Settings > Adaptive Sound+ <p> This function may not be supported depending on the model.</p>
<p>The volume of the external device cannot be adjusted.</p>	<p>Check the cable connection between the TV and the external device.</p> <p>When connecting an external speaker such as home theatre via HDMI, make sure it is connected to the HDMI (eARC) port on the TV. Make sure that the 🏠 > ⚙️ Settings > General > External Device Manager > Anynet+ (HDMI-CEC) is active on your TV.</p>
<p>I want to turn off and on the TV and audio device at the same time.</p>	<p>When you connect the Samsung Soundbar to the TV via Bluetooth, the power turns off and on together. It may not be supported depending on the Samsung Soundbar model.</p> <p>When you connect an audio device that supports HDMI eARC to the HDMI (eARC) port on the TV, the power turns off and on together.</p>

Channel and Broadcast Issues





When the TV has difficulties receiving broadcasts, these steps may help resolve the problem.

The problem	Try this!
<p>“Weak or No Signal” displayed in TV mode or cannot find channel.</p>	<p>Make sure that the external device is connected securely and turned on. Move to Sources to switch to other input sources.</p> <ul style="list-style-type: none"> •  >  Source > Sources <p>When using a set-top box or cable box, check the broadcast signals or the network that is connected to the external device.</p>
<p>The TV is not receiving all channels.</p>	<p>Confirm that the coaxial cable is securely connected to the TV.</p> <p>Run Reset or Auto Tuning.</p> <ul style="list-style-type: none"> •  >  Settings > General > Reset •  >  Settings > Broadcasting > (Auto Tuning Settings) > Auto Tuning <p> The Auto Tuning Settings may not appear depending on the model or geographical area.</p>
<p>The subtitles are not provided on a digital channel.</p> <p>I want to turn off the subtitles.</p>	<p>When watching channels with the antenna cable connected, run Subtitle Settings.</p> <ul style="list-style-type: none"> •  >  Settings > General > Accessibility > Subtitle Settings <p>Some channels may not have subtitle data.</p> <p>When watching a channel on an external device such as set-top box and cable box, turn on the subtitle function on the device. For more information, contact your service provider.</p>
<p>Broadcasting is deactivated.</p>	<p>Broadcasting is only available when Source is set to TV.</p> <p>Broadcasting cannot be accessed while you watch TV using a cable box or satellite box.</p> <p>Broadcasting cannot be accessed while a recording is in progress or the Timeshift function is running.</p>

External Device Connectivity Issues

When the TV has difficulties connecting to external devices such as a PC, game console or mobile device, these steps may help resolve the problem.

The problem	Try this!
<p>The "Mode Not Supported" message appears.</p>	<p>Adjust the output resolution of the external device to a resolution supported by the TV.</p>
<p>The video is OK but there is no audio.</p>	<p>If you are using an HDMI connection, check the audio output setting on your PC.</p> <p>If you are using a DVI to HDMI cable, a separate audio cable is required.</p> <p>To listen to the computer sound, connect external speakers to the audio output connection of the computer.</p>
<p>I want to connect to a PC and mobile device via screen mirroring.</p>	<p>To wirelessly connect the TV to your PC, read the instructions at PC > Screen Sharing (Wireless) in Connection Guide, and then try to connect.</p> <ul style="list-style-type: none"> • Home > Source > Connection Guide > PC > Screen Sharing (Wireless) <p>Confirm that the TV and your PC are connected to the same network.</p> <p>To wirelessly connect the TV to your mobile device, read the instructions at Smartphone > Screen Sharing (Smart View) in Connection Guide, and then try to connect.</p> <ul style="list-style-type: none"> • Home > Source > Connection Guide > Smartphone > Screen Sharing (Smart View) <p> For more information in The Terrace for business, refer to the provided user manual.</p> <p>If the TV has difficulties connecting to your PC or mobile device due to surrounding radio interferences, change the frequency of the wireless access band, and then try to connect.</p>
<p>No screen appears when connecting the TV to an external device.</p>	<p>For more information about how to connect an external device, run Connection Guide.</p> <ul style="list-style-type: none"> • Home > Source > Connection Guide <p>Make sure that the external device is connected securely and turned on. Move to Sources to switch to other input sources.</p> <ul style="list-style-type: none"> • Home > Source > Sources <p>Using HDMI Troubleshooting, you can check the connection to HDMI cable and external devices (takes approximately 2 minutes).</p> <ul style="list-style-type: none"> • Home > Source > Connection Guide > Video Device > HDMI Troubleshooting <p>When using a set-top box or cable box, check the broadcast signals or the network that is connected to the external device.</p>



The problem	Try this!
<p>I want to connect to a Bluetooth speaker.</p>	<p>For more information on how to connect a Bluetooth speaker, see Audio Device > Bluetooth in Connection Guide.</p> <ul style="list-style-type: none"> •  >  Source > Connection Guide > Audio Device > Bluetooth
<p>The PC screen does not appear or it flickers.</p>	<p>When the PC screen does not appear or the PC is not recognised, check the power supply of the PC and then reconnect the HDMI cable between the PC and TV. When the symptom persists, check that the PC is in Sleep mode, and then set Input Signal Plus to On.</p> <ul style="list-style-type: none"> •  >  Settings > General > External Device Manager > Input Signal Plus <p>When the set resolution is not matched, the screen may flicker. For the PC supported resolution, see 'Read Before Connecting a Computer (Supported Resolutions).'</p>

Network Issues

When the TV has difficulties connecting to the Internet, these steps may help resolve the problem.

 >  [Settings](#) > [Support](#) > [Device Care](#) > [Self Diagnosis](#) > [Smart Hub Connection Test](#) [Try Now](#)
[Try Now](#)









If the TV has trouble with network connection or TV services, check the Smart Hub connection status.



The problem	Try this!
<p>Wireless network connection failed.</p> <p>Unable to connect to a wireless access point.</p>	<p>Make sure that no items that can generate electromagnetic interferences are placed between the TV and the wireless/wired access point.</p> <p>Check if the access point is turned on. If it is on, turn it off, wait 1 or 2 minutes, and then turn it on.</p> <p>Enter the correct password if required.</p> <p>If the wireless connection fails, connect the TV to the access point via a LAN cable.</p> <p>If the TV can connect to the Internet normally via the wired connection, there might be a problem with the access point. In this case, try using a different access point.</p>
<p>Wired network connection failed.</p>	<p>Check if the LAN cable is plugged in on both ends. If it is plugged in, check if the access point is turned on. If it is on, turn it off, wait 1 or 2 minutes, and then turn it on.</p>
<p>Auto IP configuration failed.</p> <p>Unable to connect to the network.</p>	<p>Check if the LAN cable is plugged in on both ends. If it is plugged in, check if the access point is turned on.</p> <p>If the access point is on, turn it off, wait 1 or 2 minutes, and then turn it on.</p> <p>Disconnect and then reconnect the power cable of the TV or press and hold the power button for 3 seconds.</p>
<p>Connected to a local network, but not to the Internet.</p>	<ol style="list-style-type: none"> 1. Check if the Internet LAN cable is connected to the access point's external LAN port. 2. Check the DNS setting in IP Settings. <ul style="list-style-type: none"> –  >  Settings > General > Network > Network Status > IP Settings
<p>Network setup is completed, but unable to connect to the Internet.</p>	<p>If the problem persists, contact your Internet service provider.</p>

 Wired networks are not supported by some models.

Anynet+ (HDMI-CEC) Issues







When Anynet+ (HDMI-CEC) isn't working, these steps may help resolve the problem.

The problem	Try this!
<p>What is Anynet+?</p>	<p>You can use the TV's remote control to control external devices that support Anynet+ (HDMI-CEC) and that are connected to the TV via an HDMI cable. For example, if a connected external device supports Anynet+, you can have the connected device turn on or off when you turn the TV on or off.</p>
<p>Anynet+ does not work.</p>	<p>Confirm that the device is an Anynet+ device. The Anynet+ system supports Anynet+ devices only.</p> <p>Check if the power cable of the Anynet+ device is properly connected.</p> <p>Check the cable connections of the Anynet+ device.</p> <p>Go to Anynet+ (HDMI-CEC) and see if Anynet+ (HDMI-CEC) has been set to On.</p> <ul style="list-style-type: none"> •  >  Settings > General > External Device Manager > Anynet+ (HDMI-CEC) <p>Anynet+ may not function when some other functions are active, including Channel Search, Smart Hub, Initial Setup, etc.</p> <p>If you have disconnected and then reconnected the HDMI cable, scan for devices again or turn your TV off and on.</p>
<p>I want to start Anynet+.</p> <p>I also want the connected devices to turn on when the TV is turned on.</p>	<p>Move the focus to the Anynet+ device at  >  Source, press the up directional button to move to Anynet+ (HDMI-CEC), and then press the Select button.</p> <p>Check if the Anynet+ device is properly connected to the TV, and then select Anynet+ (HDMI-CEC) menu to see if Anynet+ (HDMI-CEC) is set to On.</p> <ul style="list-style-type: none"> •  >  Settings > General > External Device Manager > Anynet+ (HDMI-CEC)
<p>I want to exit Anynet+.</p> <p>It is inconvenient to turn on other devices because the TV also turns on. It is inconvenient because the connected devices (e.g. set-top box) turn off together.</p>	<p>To turn off the Anynet+ function of a device connected to the TV, turn off the Anynet+ (HDMI-CEC) function of the device.</p> <ul style="list-style-type: none"> •  >  Settings > General > External Device Manager > Anynet+ (HDMI-CEC) <p>When Anynet+ (HDMI-CEC) is turned off, the sound bar connected via HDMI (eARC) port does not turn off and on together with the TV. To prevent a specific device connected to the TV from turning off automatically, turn off the HDMI-CEC function on a specific device connected to the TV.</p>

The problem	Try this!
<p>The message "Connecting to Anynet+ device..." or "Disconnecting from Anynet+ device" appears on the screen.</p>	<p>You cannot use the remote control when the TV is configuring Anynet+ or switching to the TV viewing screen.</p> <p>Use the remote control after the TV has completed the Anynet+ configuration or has switched to the TV viewing screen.</p>
<p>The Anynet+ device won't play.</p>	<p>You cannot use the play function when Reset is in progress.</p>
<p>The connected device is not displayed.</p>	<p>Check whether the device supports Anynet+.</p> <p>Anynet+ devices must be connected to the TV using an HDMI cable. Make sure the device is connected to your TV with an HDMI cable. Some HDMI cables may not support Anynet+.</p> <p>Check whether the HDMI cable is properly connected.</p> <p>Go to Anynet+ (HDMI-CEC) and see if Anynet+ (HDMI-CEC) has been set to On.</p> <ul style="list-style-type: none"> •  >  Settings > General > External Device Manager > Anynet+ (HDMI-CEC) <p>Scan for Anynet+ devices again.</p> <p>If the connection is terminated because there has been a power failure or the HDMI cable has been disconnected, please scan for the device again.</p>

Remote Control Issues

When the remote control isn't working, these steps may help resolve the problem.

The problem	Try this!
The remote control does not work.	<p>The connection between the Samsung Smart Remote and the TV may be lost.</p> <p>Point the Samsung Smart Remote at the front of the TV, and then press and hold the  and  buttons simultaneously for 3 seconds or more.</p> <p>Also, if the remote control is not working or slow, the batteries might be low or dead. If this is the case, replace the batteries. Alkaline batteries are recommended for longer battery life.</p>
The remote control batteries run out quickly.	<p>The batteries may be consumed quickly if the remote control is used very frequently or the Voice Wake-up function is turned on.</p> <p>You can extend the battery life by turning off the Voice Wake-up function.</p> <ul style="list-style-type: none"> > Explore Now >  Settings > Voice Wake-up <p> The Voice Wake-up function may not be supported depending on the model, Voice Assistant or geographical area.</p>
External devices cannot be operated with the TV remote control.	<p>Check the cable connection between the TV and external devices.</p> <p>When the symptom persists, set it manually in  >  Source > Universal Remote Setup.</p>

Recording Issues

When Timeshift or Schedule recording aren't working, these steps may help resolve the problem.

The problem	Try this!
The Timeshift or recording function cannot be used.	<p>Check if there is a storage device connected to the TV.</p> <p>Recording will automatically stop if the signal becomes too weak.</p> <p>Check the free space on the storage device.</p> <p>The function will not work if there isn't enough storage space on the USB device.</p> <p>Before using the recording function, be sure to read all precautions. For more information, refer to "Before Using the Recording and Timeshift Functions".</p>
Cannot record videos received from an external device or Samsung TV Plus .	<p>The recording function is only available for digital broadcast channels received by the TV. You cannot record videos received from an external device or Samsung TV Plus.</p>
The "Format Device" message appears when the Timeshift or recording function is used.	<p>To use the recording function, the storage device connected to the TV must have been already formatted.</p> <p>Formatting the storage device deletes all data from it, and the storage device is formatted in NTFS.</p>
The recorded files on the TV are not played back on a PC.	<p>The recorded files on the TV can only be played back on the same TV. Those video files cannot be played back on a PC or other TV.</p>

 This function may not be supported depending on the model or geographical area.

Apps

When apps aren't working, these steps may help resolve the problem.

The problem	Try this!
I launched an app, but it's in a different language. How can I change the language?	Languages supported by an app may be different from the TV Language set in the menu. The ability to change the language depends on the app's provider.
The app does not work properly. Its image quality is poor.	Check the network connection. When the network speed is slow, the app may not work or its image quality may be poor. The services of your application are not provided by the TV but by the application service provider. Refer to the Help section on the application service provider's website.

Media Files









When files don't play, this may help resolve the problem.

The problem	Try this!
Some files are interrupted during playback.	This problem may occur with unsupported files or high-bitrate files. Most files can be played back, but some files may not play smoothly.
Some files can't be played.	Some files that use an unsupported codec may not be played back. Make sure that the codec is supported by the TV. For more information about the supported codecs, refer to " Read Before Playing Photo, Video or Music Files ".

Voice Assistant Issues





When the Voice Assistant isn't working, these steps may help resolve the problem.





 The **Voice Wake-up** function may not be supported depending on the model or geographical area.

The problem	Try this!
<p>The voice commands do not work well.</p>	<p>Voice commands may differ depending on the Voice Assistant.</p> <p>Refer to the command examples for each Voice Assistant.</p> <ul style="list-style-type: none"> • Bixby:  > Explore Now • Amazon Alexa:  >  Settings > General > Voice > Amazon Alexa Settings • Google Assistant:  >  Settings > General > Voice > Google Assistant Settings
<p>Bixby or Alexa answers automatically.</p>	<p>The TV may recognise an ambient noise or everyday conversation as a call to Voice Assistant.</p> <p>Turn off the Voice Wake-up function or set the Wake-up Sensitivity to Low.</p> <ul style="list-style-type: none"> •  > Explore Now >  Settings > Voice Wake-up
<p>I spoke "Hi, Bixby" but Bixby does not answer.</p> <p>I spoke "Alexa" but Amazon Alexa does not answer.</p>	<p>The Samsung Smart Remote may not recognise your voice when it is far away from you, turned upside down, or located in an environment with loud ambient noise.</p> <ul style="list-style-type: none"> • Use the Samsung Smart Remote less than 1.5 m with the remote control buttons facing upward. (There is a built-in microphone on the front of the Samsung Smart Remote.) • Do not place the Samsung Smart Remote near the TV speaker or an audio speaker. <p>Turn on the Voice Wake-up function.</p> <ul style="list-style-type: none"> •  > Explore Now >  Settings > Voice Wake-up
<p>With Samsung Smart Remote, the following features are available except for voice recognition.</p> <p>There is no response even if the voice entry button is pressed.</p>	<p>Try pairing the remote control with the TV.</p>
<p>During voice recognition, the heavy load message appears and the function does not work.</p>	<p>Unplug and then plug the TV power cable and then try again after 1 minute and 30 seconds. It may take a while if the voice recognition server is being inspected.</p>
<p>I want to see weather information of the desired area.</p>	<p>Say with the area name included.</p>

Other issues

Use these procedures to resolve other issues that may occur in relation to the product.

The problem	Try this!
The TV is hot.	<p>Watching TV for an extended period of time causes the panel to generate heat. The heat from the panel is dissipated through internal vents running along the top of the TV.</p> <p>The bottom, however, may feel hot to the touch after extended use.</p> <p>Children watching TV need constant adult supervision to prevent them from touching the TV.</p> <p>This heat, however, is not a defect and does not affect the TV's functionality.</p>
The TV smells of plastic.	This smell is normal and will dissipate over time.
The settings are lost after 5 minutes or every time the TV is turned off.	<p>If Usage Mode is set to Retail Mode, the TV's audio and video settings are automatically reset every 5 minutes.</p> <p>Change Usage Mode to Home Mode.</p> <ul style="list-style-type: none">•  >  Settings > General > System Manager > Usage Mode
The TV is tilted to the side.	Remove the base stand from the TV and reassemble it.
The stand is wobbly or crooked.	Refer to the Quick Setup Guide and make sure that the stand is assembled correctly.
A POP (TV's internal banner ad) appears on the screen.	<p>Change Usage Mode to Home Mode.</p> <ul style="list-style-type: none">•  >  Settings > General > System Manager > Usage Mode
The TV is making a popping noise.	<p>The expansion and contraction of the TV's outer casing may cause a popping noise.</p> <p>This does not indicate a product malfunction.</p> <p>The TV is safe to use.</p>

The problem	Try this!
<p>The TV is making a humming noise.</p>	<p>Your TV utilises high-speed switching circuits and high levels of electrical current. Depending on the TV's brightness level, the TV may seem slightly noisier than a conventional TV.</p> <p>Your TV has undergone strict quality control procedures that meet our demanding performance and reliability requirements.</p> <p>Some noise coming from the TV is considered normal and is not an acceptable cause for an exchange or refund.</p>
<p>The software update over the Internet has failed.</p>	<p>Check the network connection status.</p> <ul style="list-style-type: none"> •  >  Settings > General > Network > Network Status <p>If the TV is not connected to a network, connect it to a network.</p> <p>The upgrade stops if you already have the latest software version.</p>
<p>The TV narrates the screen events in voice-over.</p>	<p>To turn off Voice Guide, move the focus from Accessibility Shortcuts to Voice Guide and then press the Select button. You can turn on or off Voice Guide. To run Accessibility Shortcuts, see the following:</p> <ul style="list-style-type: none"> • Press and hold the +/- (Volume) button on your Samsung Smart Remote. • Press the AD/SUBT. button on the standard remote control or press and hold the MUTE button. You can turn off the Voice Guide function by going to the General menu. •  >  Settings > General > Accessibility > Voice Guide Settings > Voice Guide









Diagnosing TV operational issues

You can diagnose issues with your TV and Smart Hub and run reset functions.

 >  [Settings](#) > [Support](#) > [Device Care](#) > [Self Diagnosis](#) Try Now

You can use the [Picture Test](#) to help diagnose video issues and the [Sound Test](#) to diagnose sound issues. You can also view signal strength information for over-the-air digital signals, test the Smart Hub Internet connection and run the Smart Hub and TV factory reset functions.

- [Video Test](#)
- [Picture Test](#)
- [Sound Test](#)
- [HDMI Troubleshooting](#)
- [Signal Information](#)
- [Smart Hub Connection Test](#)
- [Reset Smart Hub](#)

The problem	Try this!
Cannot select Signal Information in Self Diagnosis .	Verify that the current channel is a digital channel. Signal Information is only available for digital channels. <ul style="list-style-type: none"> •  >  Settings > Support > Device Care > Self Diagnosis > Signal Information
Reset Smart Hub	Resets all Smart Hub settings to their factory defaults and deletes all information related to Samsung accounts, linked service accounts, Smart Hub service agreements and Smart Hub applications. <ul style="list-style-type: none"> •  >  Settings > Support > Device Care > Self Diagnosis > Reset Smart Hub
Reset picture	Resets current picture settings to the default settings. <ul style="list-style-type: none"> •  >  Settings > Picture > Expert Settings > Reset Picture
Reset sound	Resets current sound settings to the default settings. <ul style="list-style-type: none"> •  >  Settings > Sound > Expert Settings > Reset Sound

Getting Support

Get help directly from Samsung if you have a problem with your TV.

Getting support through Remote Management

 >  [Settings](#) > [Support](#) > [Remote Management](#) [Try Now](#)

After consenting to our service agreement, you can use [Remote Management](#) to access Remote Support and have a Samsung service technician diagnose your TV, correct problems and update your TV's software remotely via the web. You can also turn [Remote Management](#) on and off.



 This function requires an Internet connection.

Finding the contact information for service

 >  [Settings](#) > [Support](#) > [About This TV](#) [Try Now](#)

You can view the address of the Samsung website, the call centre phone number, your TV's model number, your TV's software version, Open Source License and other information you may need to get service support from a Samsung call agent or the Samsung website.

 You can also view information by scanning the QR code of your TV.

 You can also start this function by pressing and holding the  button for 5 or more seconds. For the standard remote control, press and hold the  (Play) button for 5 or more seconds. Continue holding the button until the customer information pop-up window appears.

Requesting service

 >  [Settings](#) > [Support](#) > [Device Care](#) > [Request Support](#) [Try Now](#)

You can request service when you encounter a problem with the TV. Select the item matching the problem that you encountered, enter the required item, move the focus to [Next](#), and then press the Select button. Select [Request Now](#) > [Send](#) or [Schedule Appointment](#) > [Request](#) > [Send](#). Your service request will be registered. The Samsung Contact Centre will contact you to set up or confirm your service appointment.

 You must agree to the terms and conditions for the service request.

 This function may not be supported depending on the geographical area.

 This function requires an Internet connection.

FAQ

In this section, you'll find the answers to the e-Manual questions we get asked about most often.

The TV Screen does not Display Properly

When the TV screen is bad, let's find out how to simply check whether the cause is caused by the product or the external environment by broadcasting signals and cables.

When the TV screen does not display properly

 The colour and design of the TV and its accessories and the features may differ depending on the model or geographical area.



Check the antenna and input cable connections.

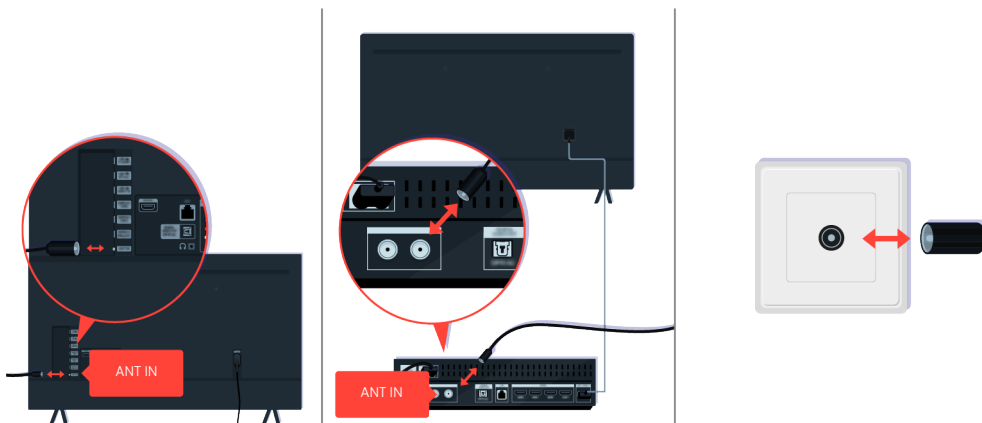

Check the antenna and input cable connections.

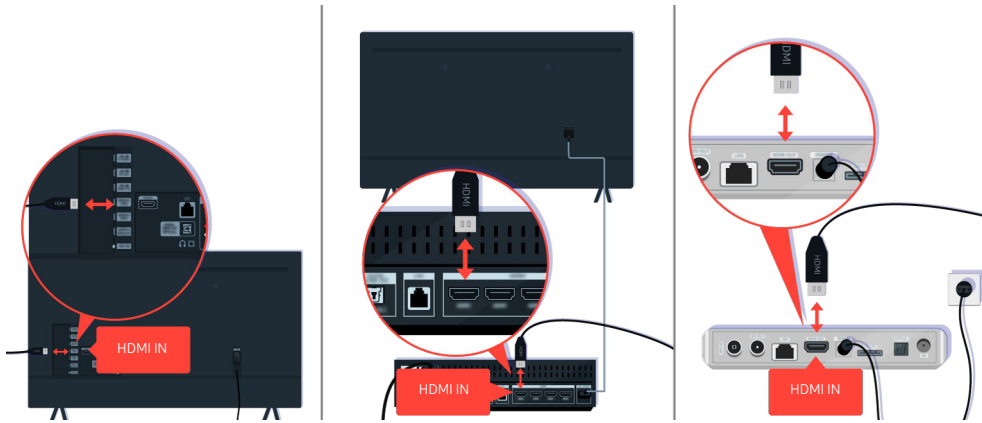

Check the antenna and HDMI cable connections.



If the issue persists, define exactly what is wrong with the display. For example, mosaics and blocks, multiple lines or white dots or fixed horizontal or vertical lines.



Try changing channels using the remote control.

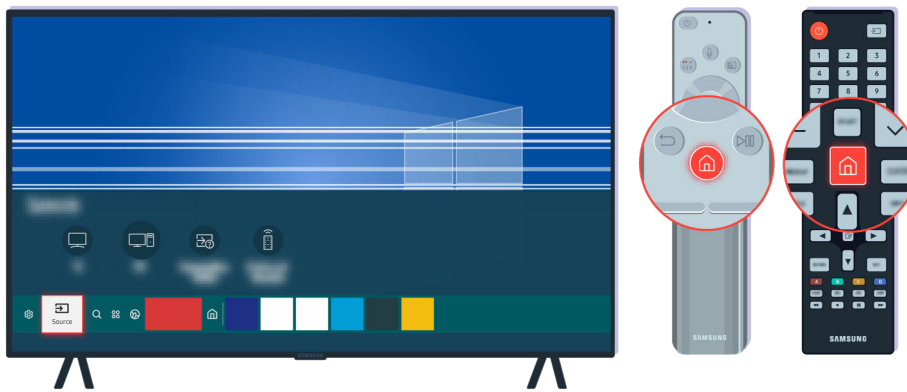

Press the  button, select **Source**, choose another input source.



If the same problem persists, run a diagnostic test. On the remote control, press the  button.



Select  >  **Settings** > **Support** > **Device Care** > **Self Diagnosis** > **Picture Test**.

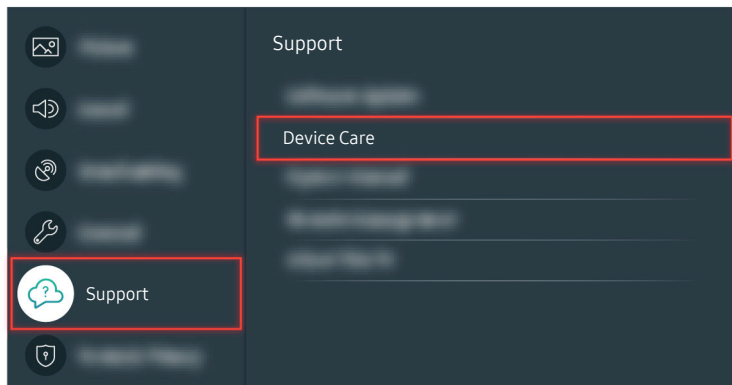

Select  >  **Settings** > **Support** > **Device Care** > **Self Diagnosis** > **Picture Test**.

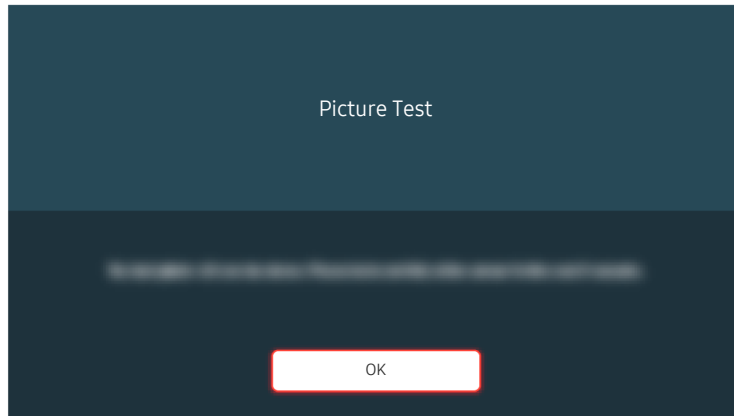

When a message appears, select **OK** and follow the on-screen instructions to complete the test.



When a message appears, select **OK** and follow the on-screen instructions to complete the test.

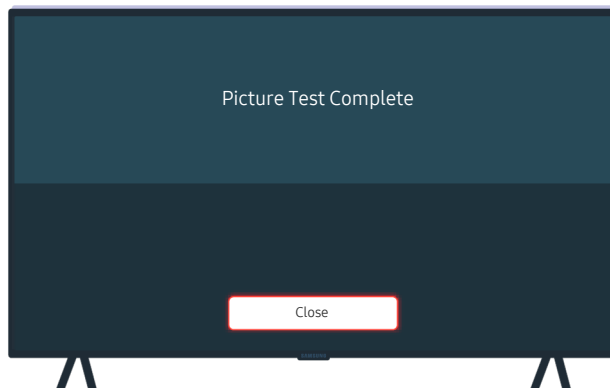



When a message appears, select **Close** and follow the on-screen instructions to complete the test.





If the problem disappears during the test, check your TV signal. On the remote control, press the  button.

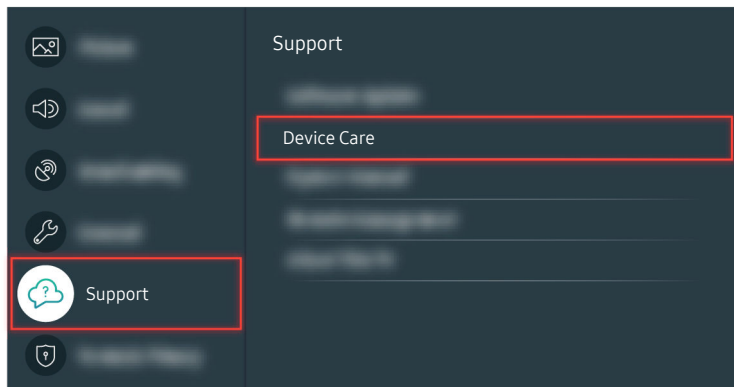

Select  >  **Settings** > **Support** > **Device Care** > **Self Diagnosis** > **Signal Information** to check the signal strength.



Select  >  **Settings** > **Support** > **Device Care** > **Self Diagnosis** > **Signal Information** to check the signal strength.

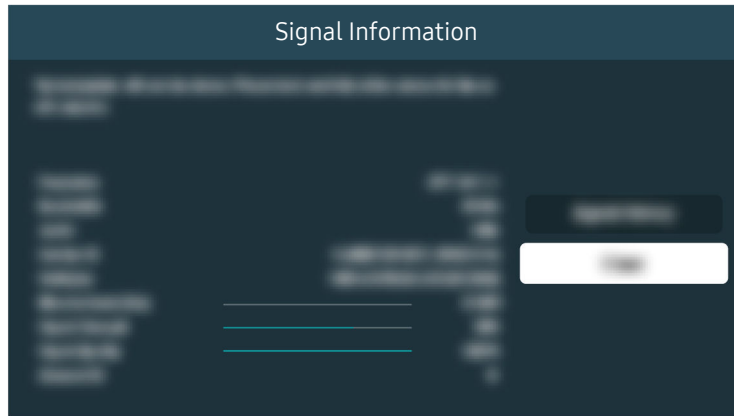

Check whether the signal strength is too weak or not.

Related menu path

[Home](#) > [Settings](#) > [Support](#) > [Device Care](#) > [Self Diagnosis](#) > [Picture Test](#) [Try Now](#)

[Home](#) > [Settings](#) > [Support](#) > [Device Care](#) > [Self Diagnosis](#) > [Signal Information](#) [Try Now](#)

The TV does not Turn On

If there is no screen on the TV, it often occurs when the contact point of the power cable is loose or the peripheral device is turned off.

When your TV does not turn on

 The colour and design of the TV and its accessories and the features may differ depending on the model or geographical area.

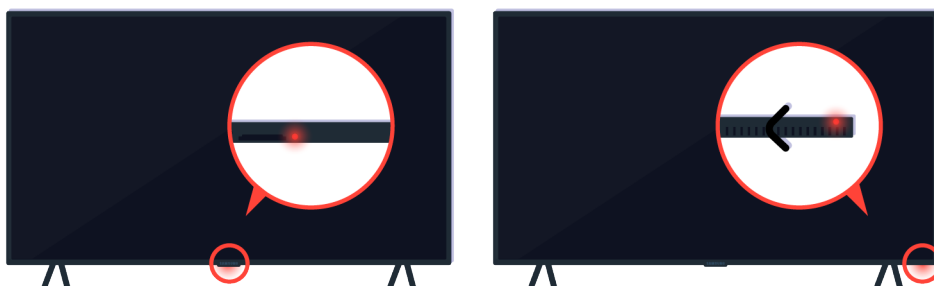

If your TV does not turn on, check whether the remote control sensor is on.

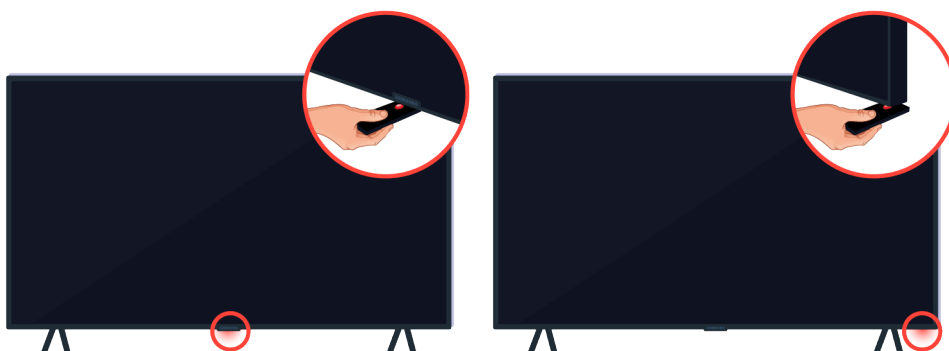

By holding a reflective object like mirror under the TV, you can easily find the remote control sensor.

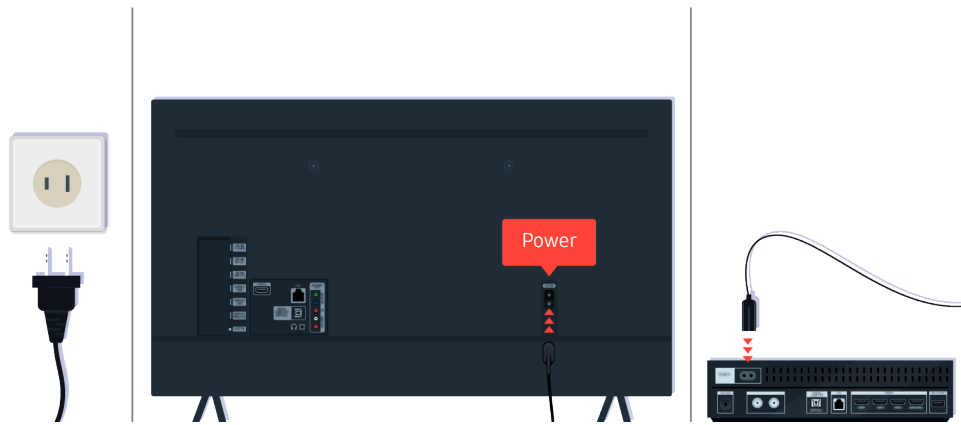

If the remote control sensor is not turned on, unplug the power cable and plug it back in.

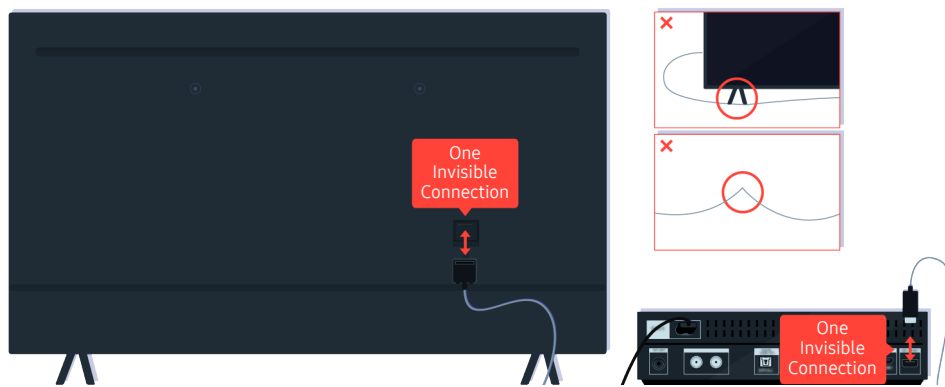

Disconnect and reconnect the One Invisible Connection cable between the TV and the One Connect (OC) Box. Make sure that the One Invisible Connection cable is not pinched or bent sharply.

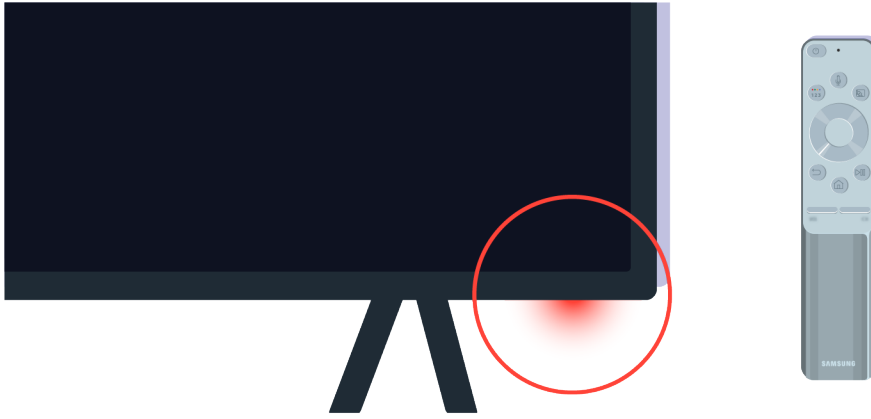

Check the remote control sensor again. If the LED is turned on, press the power button on your remote control to turn on your TV.

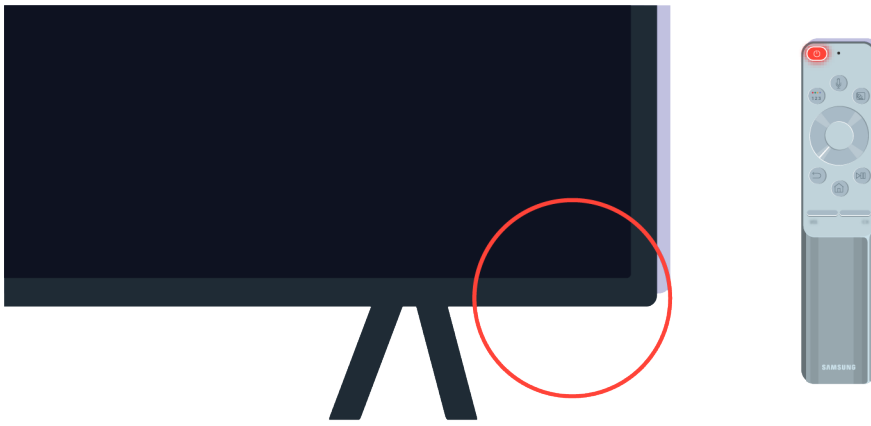

If the remote control sensor turns off when you press the power button, your TV is correctly connected to the power supply.



If the TV screen is still blank, softly tap it with your finger. If the part of the screen you tapped on blinks, your TV is correctly connected to the power supply.



On the remote control, press the  button. When the Home Screen appears, the TV is turned on but the connected external device does not work or any connection problem occurs.

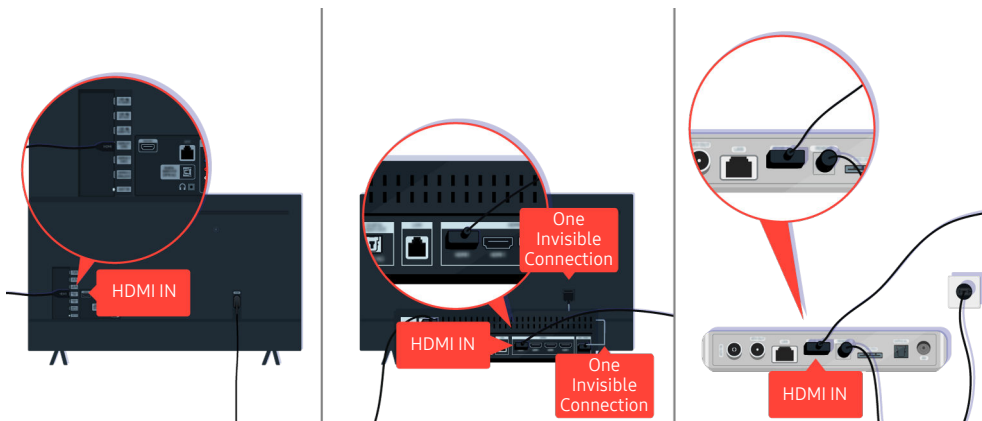

Check the connection of the HDMI cable to your TV or One Connect Box.



Make sure that the external device is turned on.



If it does not turn on, make sure the power cable is properly connected to the device and to the wall outlet.



If it does not turn on, make sure the power cable is properly connected to the device and to the wall outlet.

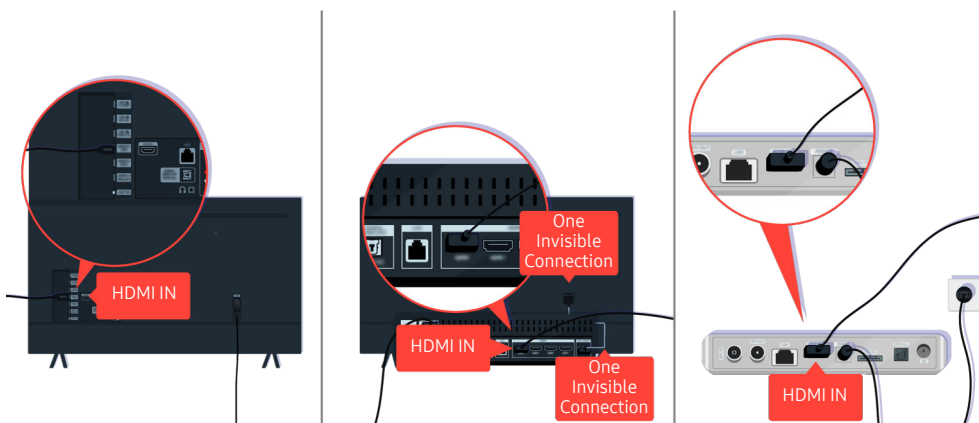

Check the connection of the HDMI cable to your TV or One Connect Box.

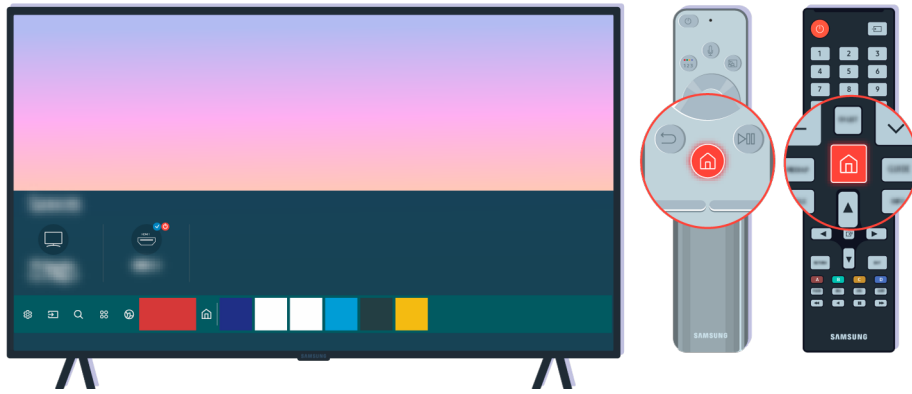

Also make sure that the correct source is selected on the Home Screen (🏠 > 📺 [Source](#)).



If the same problem continues, try connecting another external device to the TV using an HDMI cable. If the display is correct, your external device may be faulty.

The TV Screen Breaks Up or No Sound Comes Out of the Sound Bar

No TV sound in the sound bar or disconnected symptoms are often caused by loose connection terminals or poor contact of the outlet.

When the TV does not connect with an external device properly

 The colour and design of the TV and its accessories and the features may differ depending on the model or geographical area.



When the TV screen breaks up,

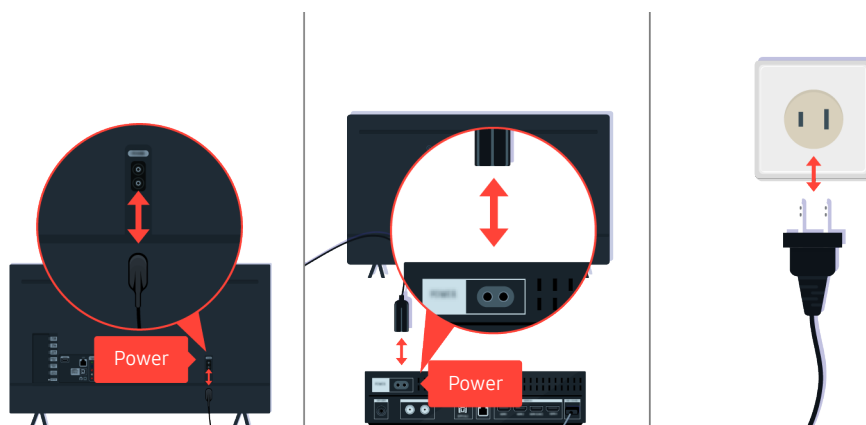

First disconnect and reconnect the power cables and HDMI cables on the back of your TV or the One Connect (OC) Box, then unplug the power cable and plug it back into the wall outlet.

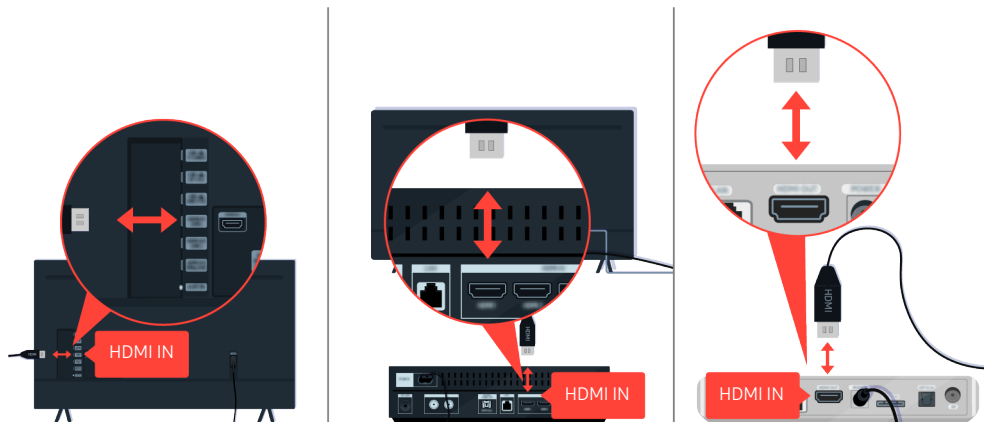

First disconnect and reconnect the power cables and HDMI cables on the back of your TV or the One Connect (OC) Box, then unplug the power cable and plug it back into the wall outlet.



If the external device support 4K UHD or 8K UHD videos, use a dedicated HDMI cable for each resolution.

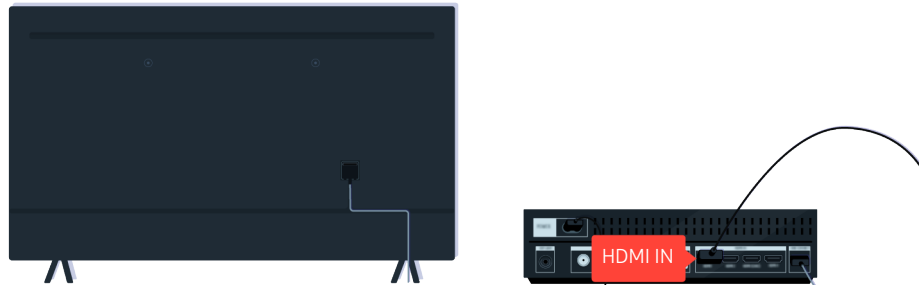

For better video quality, use an HDMI cable if your external device supports it.

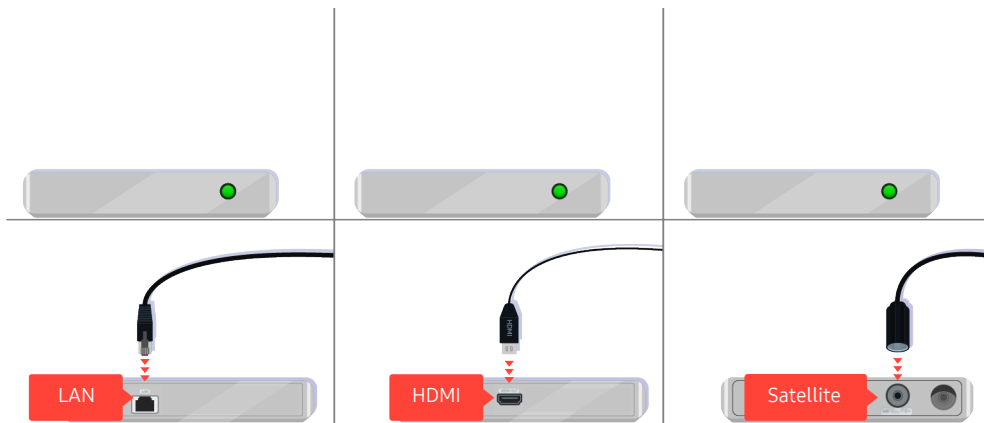

If you are using a set-top box, check the cable connection. The cable you need to check depends on the type of set-top box.

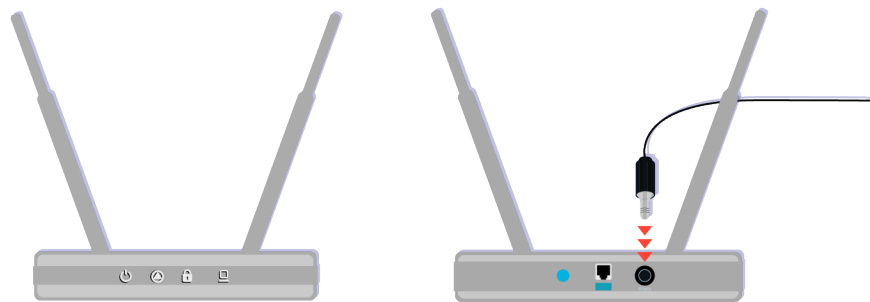

Make sure that your access point is working properly. If not, disconnecting and reconnecting the access point power cable may be required.

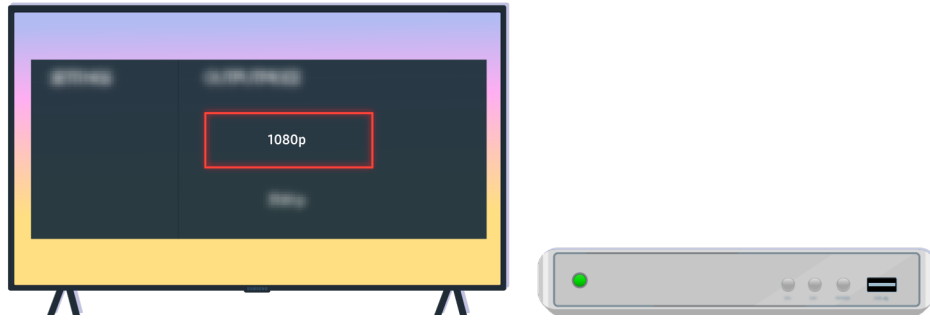

If the problem persists, check the video output settings in the settings menu of the external device and ensure that your TV supports the video output mode.

FHD TVs support up to 1080p video output and UHD TVs support up to 2160p video output.

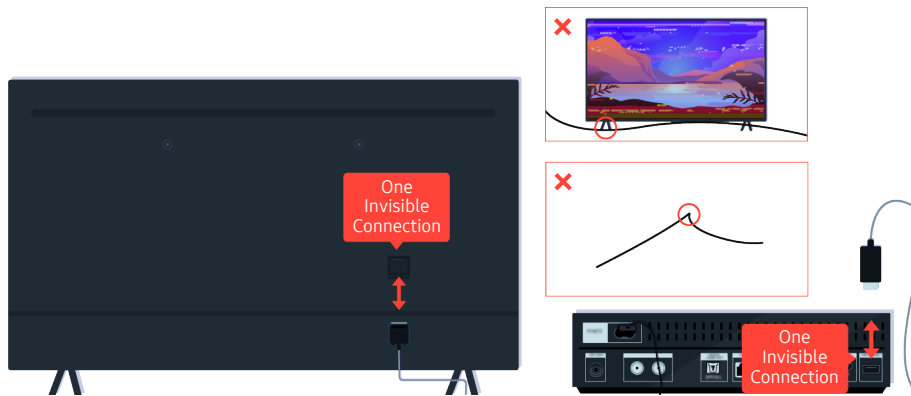

If the problem persists and if your TV uses the One Invisible Connection, disconnect and reconnect the One Invisible Connection to the TV and the One Connect (OC) Box. Ensure that the One Invisible Connection is not pinched or bent sharply.



If no sound comes out of your Sound Bar and if it is connected to the TV with an HDMI cable, check the HDMI (eARC) connector on the back of the TV.

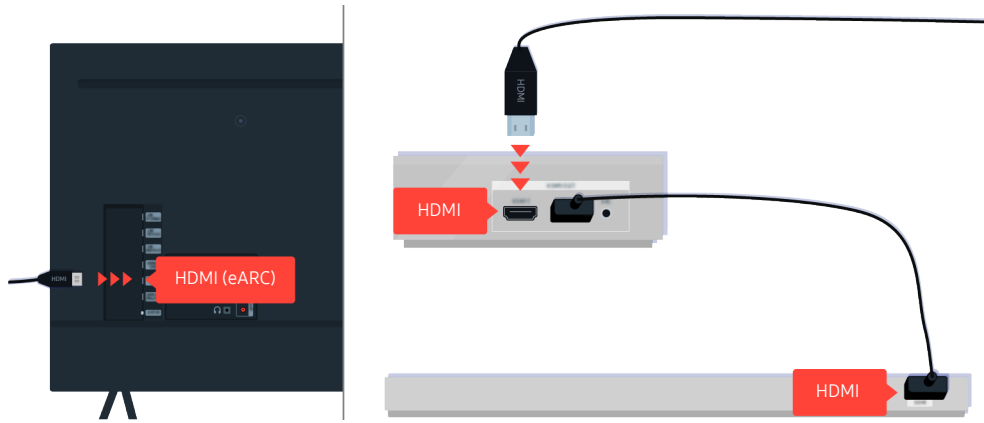

If your Sound Bar is connected to a receiver, and the receiver is connected to the TV using an HDMI cable, check the HDMI connector on the back of the TV. The cable must be connected to the HDMI (eARC) port on your TV.

Internet Access is not Available

When the TV has difficulties connecting to the Internet, these steps may help resolve the problem.



When the TV can't connect to the Internet

 The colour and design of the TV and its accessories and the features may differ depending on the model or geographical area.



If your TV is not connected to the internet, check the network and the status of your access point.



On the remote control, press the  button and move to  **Settings** using the directional button.



Select  >  **Settings** > **General** > **Network** > **Network Status** to check the network status.

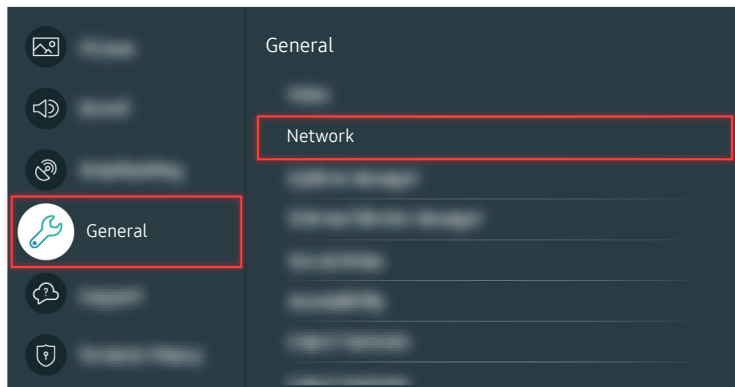

Select  >  **Settings** > **General** > **Network** > **Network Status** to check the network status.

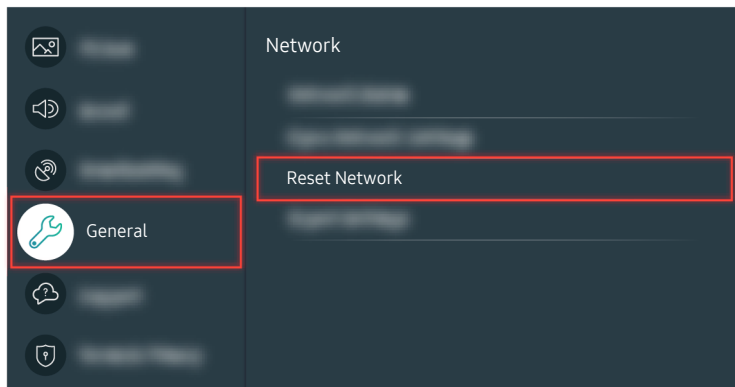

If the network isn't connected, a network reset may be required.

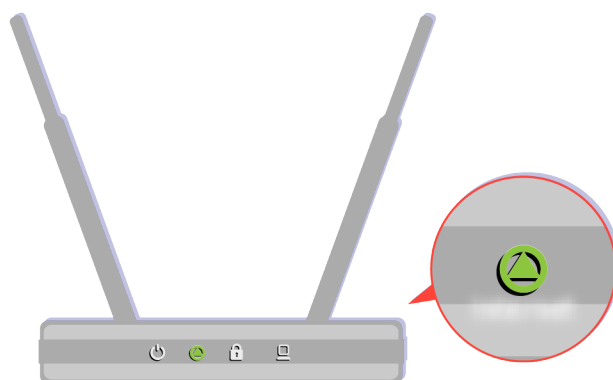

Make sure that your access point is working properly. Check the LED indicators on your access point to make sure it is operating normally.

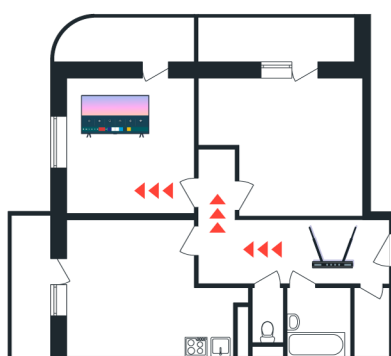

If you are using a wireless access point, check the access point location. If the access point is too far from the TV, move it closer.



Try rebooting the access point by disconnecting and reconnecting the power connector. It may take 1 to 2 minutes until the access point comes back online after a reboot.

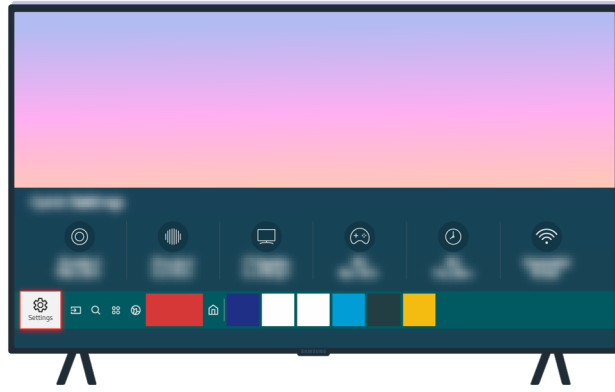

If the same problem continues, select  > [Settings](#) > [General](#) > [Network](#) > [Network Status](#) > [IP Settings](#) to change to a different DNS server. If a test occurs, cancel it and select [IP Settings](#).

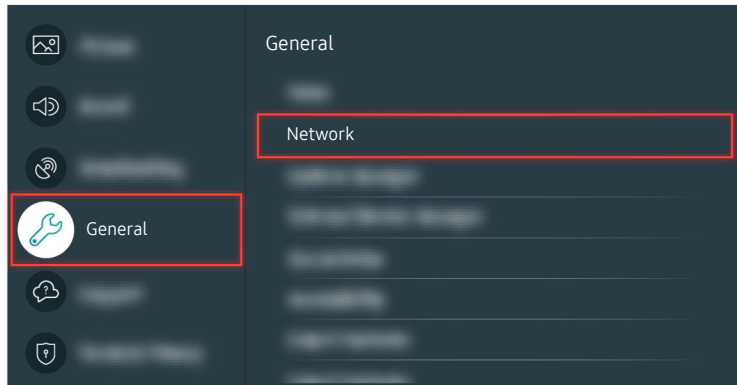

If the same problem continues, select  > [Settings](#) > [General](#) > [Network](#) > [Network Status](#) > [IP Settings](#) to change to a different DNS server. If a test occurs, cancel it and select [IP Settings](#).

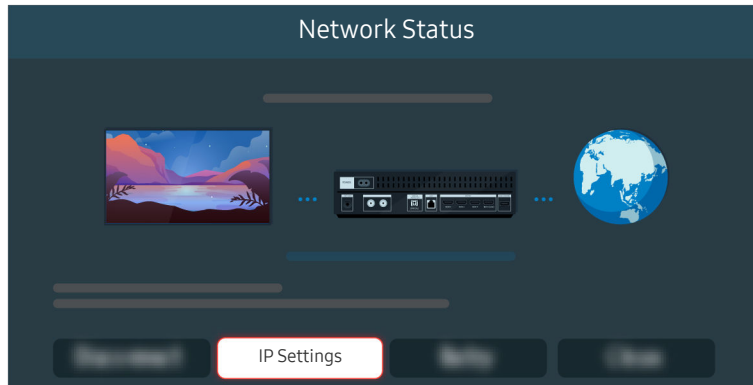

If the same problem continues, select  > [Settings](#) > [General](#) > [Network](#) > [Network Status](#) > [IP Settings](#) to change to a different DNS server. If a test occurs, cancel it and select [IP Settings](#).

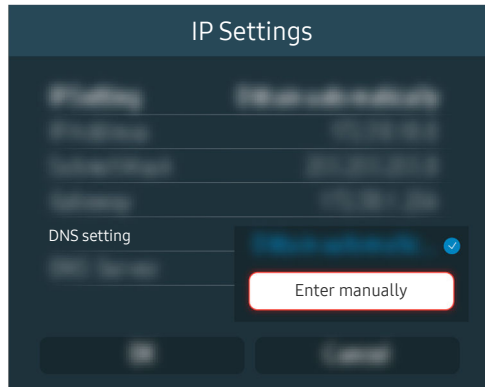

Select [DNS setting](#) > [Enter manually](#).

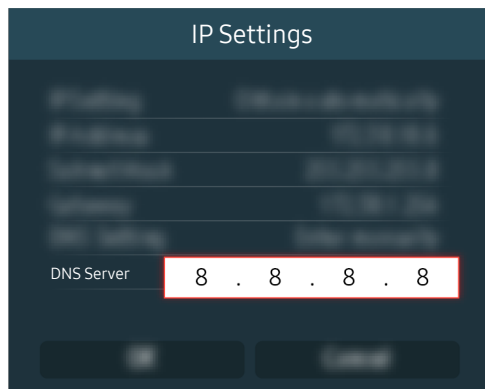

Select [DNS Server](#), enter 8.8.8.8, then select [OK](#).

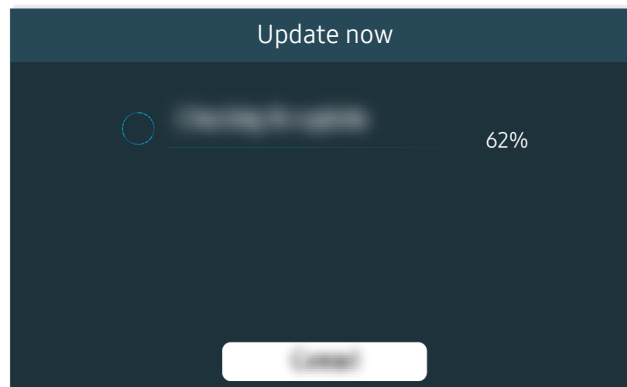

If the same problem continues, a software update or factory reset may be required.

Related menu path

- [Settings](#) > [General](#) > [Network](#) > [Network Status](#) [Try Now](#)
- [Settings](#) > [General](#) > [Network](#) > [Reset Network](#) [Try Now](#)
- [Settings](#) > [Support](#) > [Software Update](#) [Try Now](#)
- [Settings](#) > [General](#) > [Reset](#) [Try Now](#)

There is No Sound or the Speakers are Making Odd Sound

When the sound is not good, let's find out how to simply check whether the cause is caused by the product or the external environment by broadcasting signals and cables.

When no sound comes out of the TV, or the sound is breaking up

 The colour and design of the TV and its accessories and the features may differ depending on the model or geographical area.





If your TV does not produce any sound, press the Volume + button to increase the volume.





If your TV is connected to an external device, check the volume of the external device.



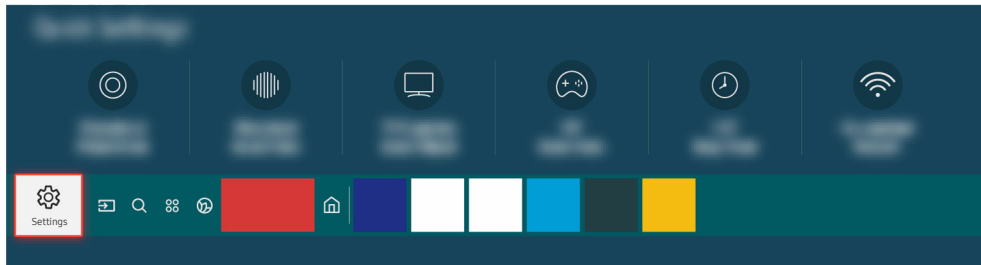

Check the volume on the screen. If a number for the TV volume is not displayed, select  >  **Settings** > **Sound** > **Sound Output**. Then, select **TV Speaker**.

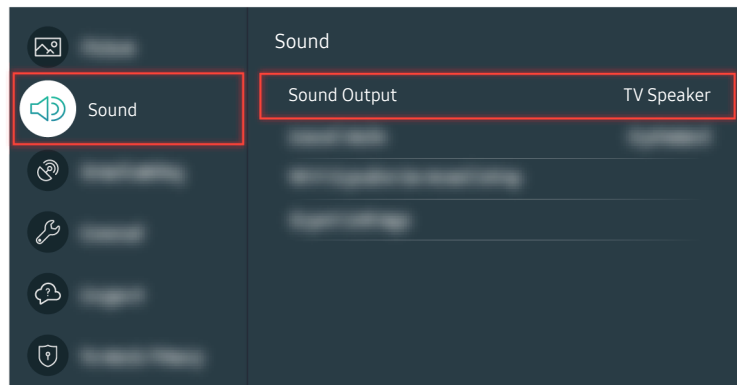

Check the volume on the screen. If a number for the TV volume is not displayed, select  >  **Settings** > **Sound** > **Sound Output**. Then, select **TV Speaker**.



Check the volume on the screen. If a number for the TV volume is not displayed, select  >  **Settings** > **Sound** > **Sound Output**. Then, select **TV Speaker**.

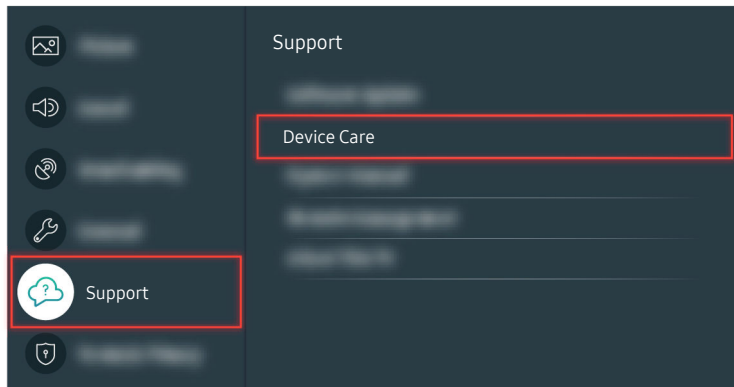

To check sound output, select  >  **Settings** > **Support** > **Device Care** > **Self Diagnosis** > **Sound Test**.

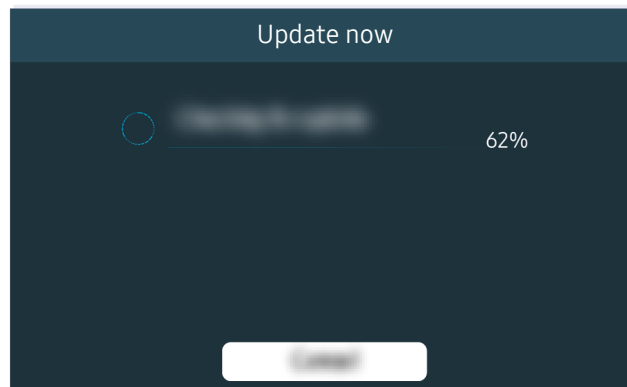

If the same problem continues, a software update or factory reset may be required.



If there is sound but it is not clear, run a diagnostic test. On the remote control, press the  button.

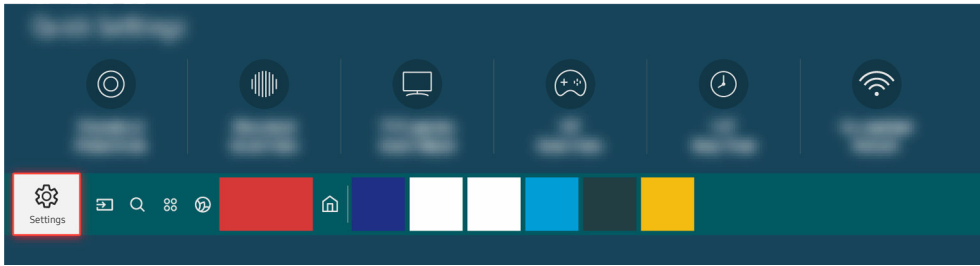

Go to  >  **Settings** > **Support** > **Device Care** > **Self Diagnosis** > **Sound Test** to check the sound.

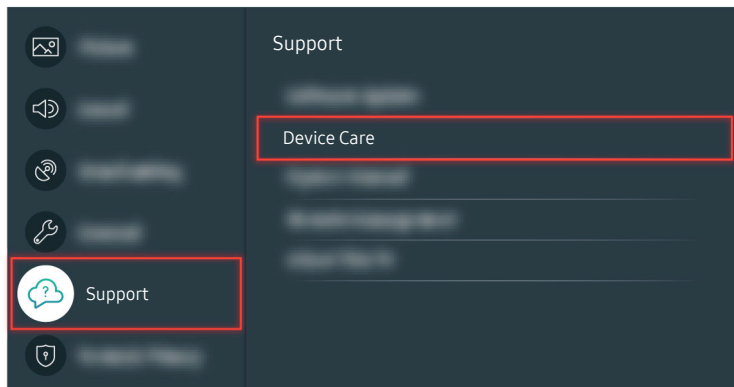

Go to  >  **Settings** > **Support** > **Device Care** > **Self Diagnosis** > **Sound Test** to check the sound.

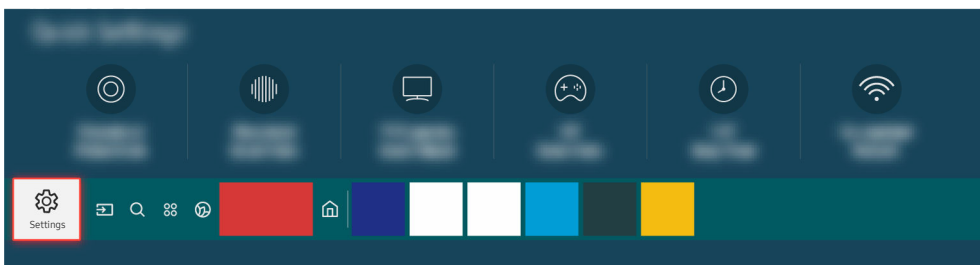

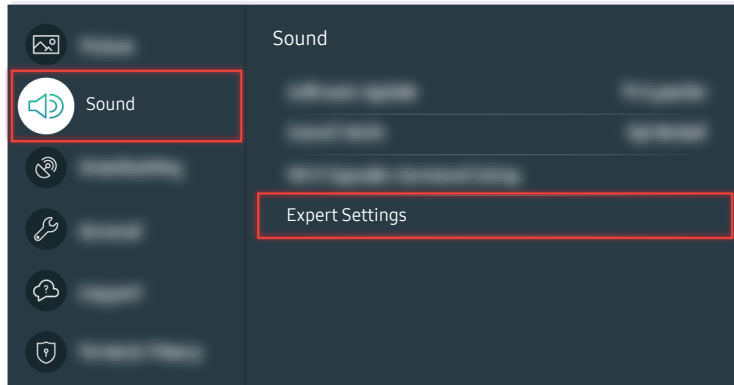

If the test reveals a problem, select  >  **Settings** > **Sound** > **Expert Settings** > **Reset Sound**.



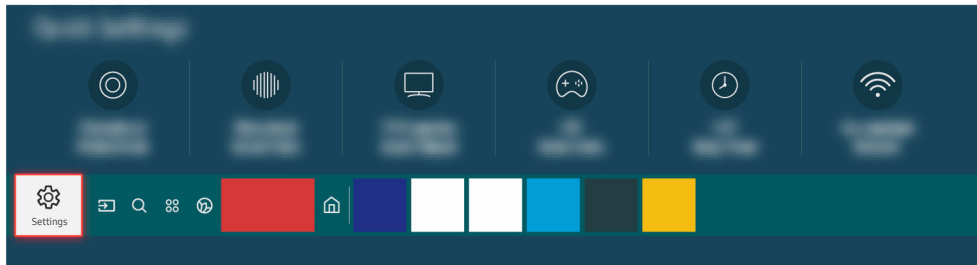

If the test reveals a problem, select  >  [Settings](#) > [Sound](#) > [Expert Settings](#) > [Reset Sound](#).

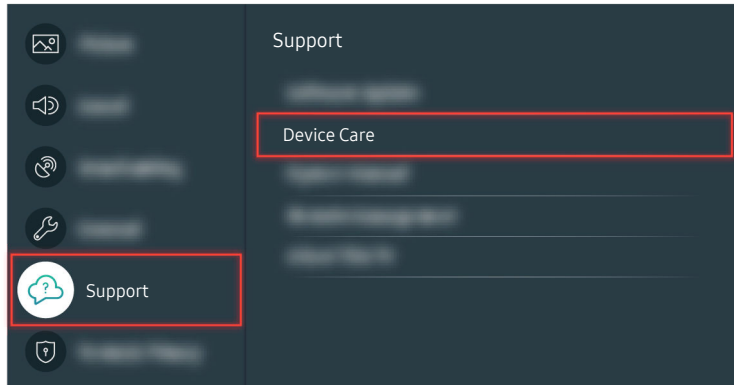

If the test shows no problems, select  >  [Settings](#) > [Support](#) > [Device Care](#) > [Self Diagnosis](#) > [Signal Information](#).



If the test shows no problems, select  >  **Settings** > **Support** > **Device Care** > **Self Diagnosis** > **Signal Information**.

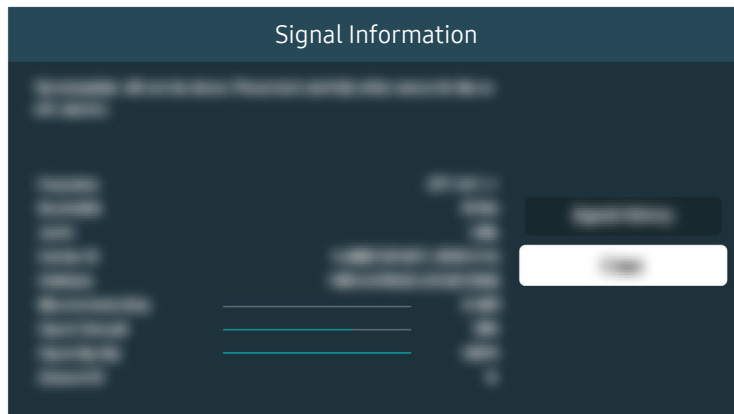

Check whether the signal strength is too weak or not.

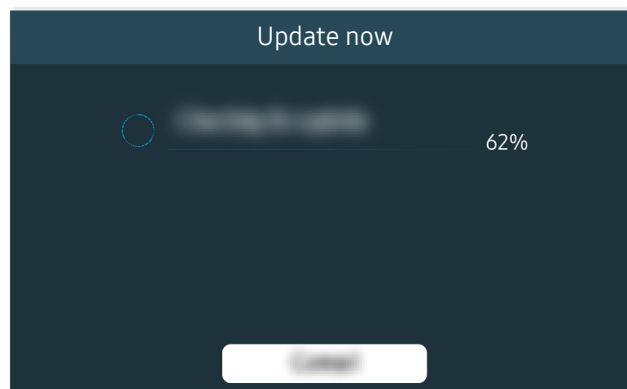

If the same problem continues, a software update or factory reset may be required.

Related menu path

 >  Settings > Sound > Sound Output [Try Now](#)

 >  Settings > Support > Device Care > Self Diagnosis > Sound Test [Try Now](#)

 >  Settings > Sound > Expert Settings > Reset Sound [Try Now](#)

 >  Settings > Support > Device Care > Self Diagnosis > Signal Information [Try Now](#)

 >  Settings > Support > Software Update [Try Now](#)

 >  Settings > General > Reset [Try Now](#)

The Remote Control does not Work

If the remote control is not working, the battery is weakened or the Samsung Smart Remote is not paired.

When the remote control does not work

 The colour and design of the TV and its accessories and the features may differ depending on the model or geographical area.

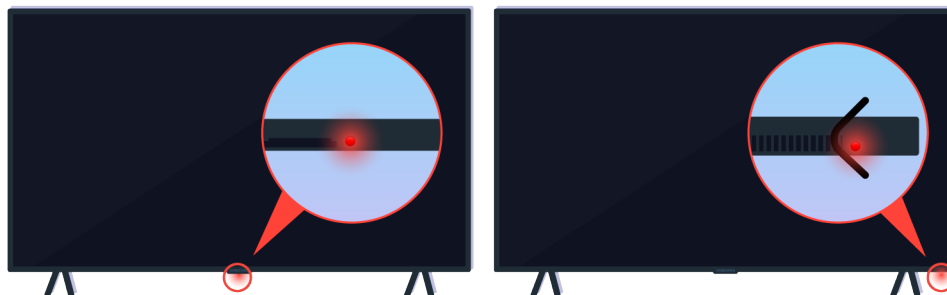

Verify that the infrared remote control signal is being transmitted and received.



Make sure the remote control sensor on the TV is blinking.



Remove any obstruction covering the receiver on your TV.



Make sure the remote control works properly.

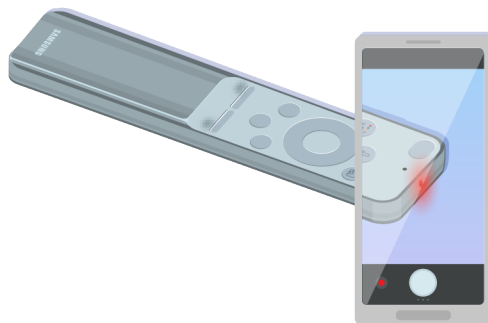

You can check whether the signal is being transmitted by pressing the power button and observing the front tip of the remote control through the camera on your smartphone.

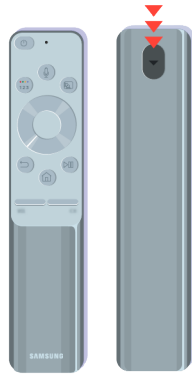

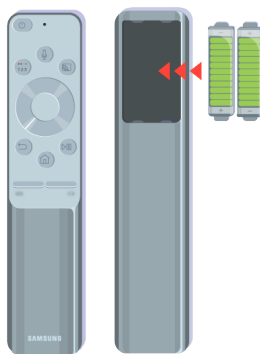

If you don't see any infrared signal, replace the batteries of the remote control.



If you don't see any infrared signal, replace the batteries of the remote control.



Press the  and  buttons simultaneously to display the pairing animation clip.



Follow the on-screen instructions to proceed with the pairing.

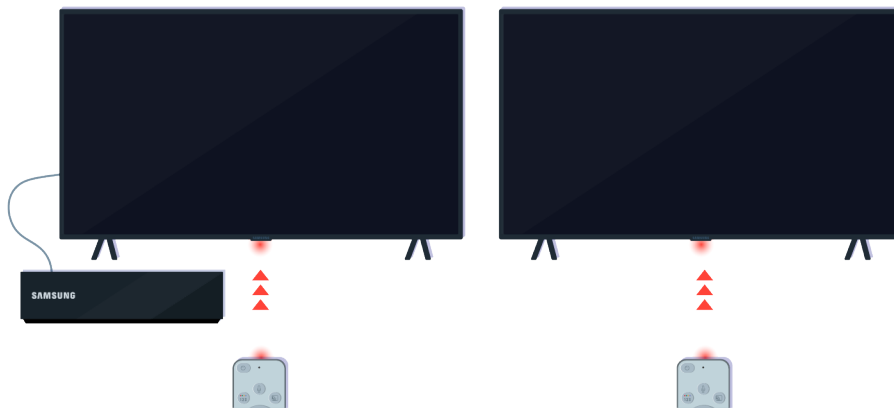

The remote control will work more effectively if you point it at the remote control sensor.



If the same problem continues, try using the appropriate SAMSUNG remote control for your TV model.

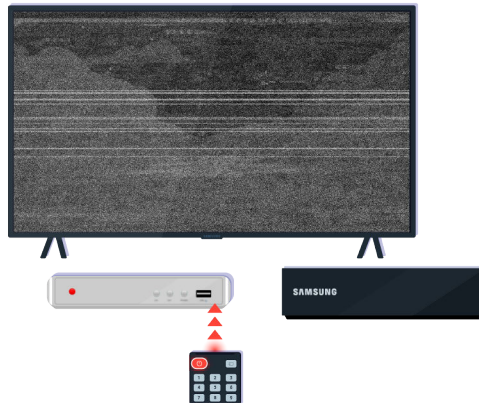

If you use an Multi-Brand Remote (MBR) or universal remote and your remote cannot operate an external device, move the external device closer to the One Connect Box.



Updating the Software

If you want to keep the TV in its best condition or if you have an abnormality intermittently, please update it to the latest version.

Updating the latest TV's software

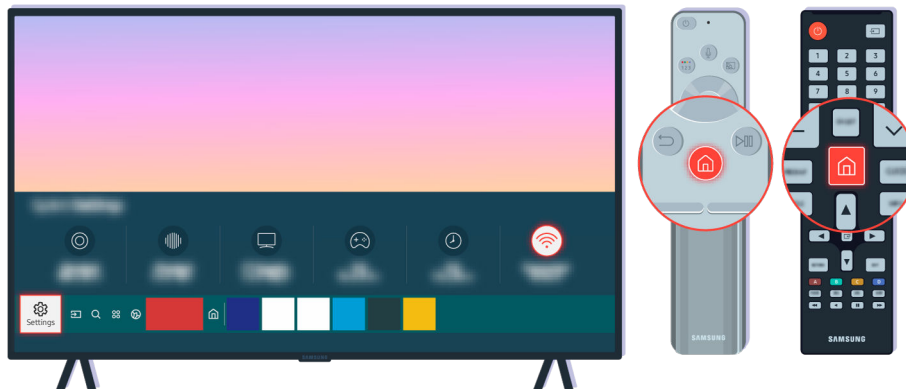
 The colour and design of the TV and its accessories and the features may differ depending on the model or geographical area.



If your TV is connected to the Internet, you can set it to receive periodic updates automatically. On the remote control, press the  button and move to  **Settings** using the directional button.

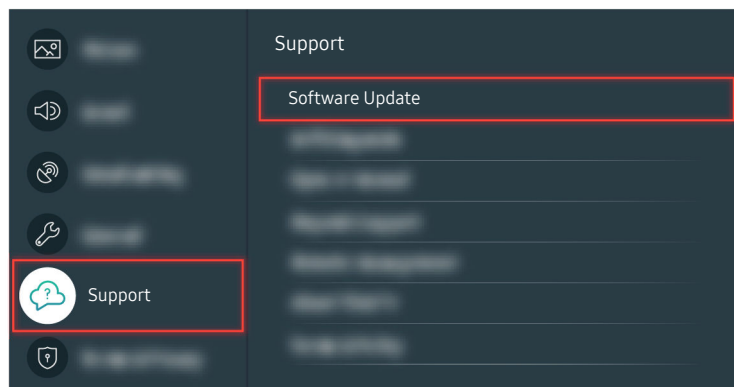

To enable automatic updates, select  >  **Settings** > **Support** > **Software Update** > **Auto update**.

 For more information in The Terrace for business, refer to the provided user manual.



If your TV is not connected to the Internet, you can update the software using a USB drive.



Select  >  **Settings** > **Support** > **About This TV** and check the model code and software version.

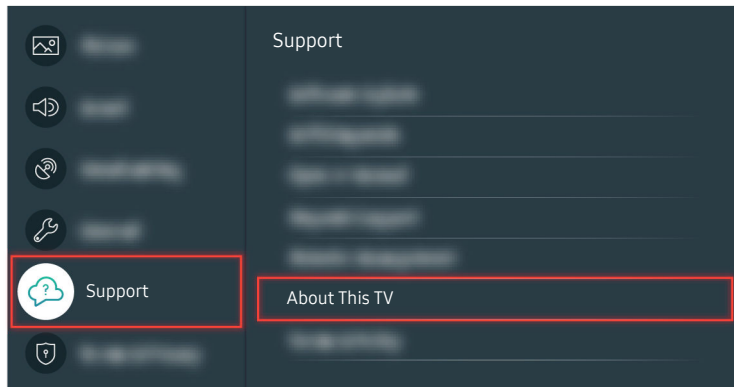

Select  >  **Settings** > **Support** > **About This TV** and check the model code and software version.

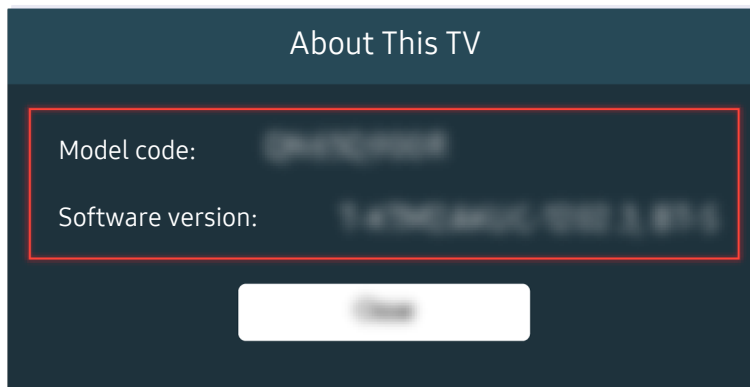

Select  >  **Settings** > **Support** > **About This TV** and check the model code and software version.



Using a computer, connect to www.samsung.com.

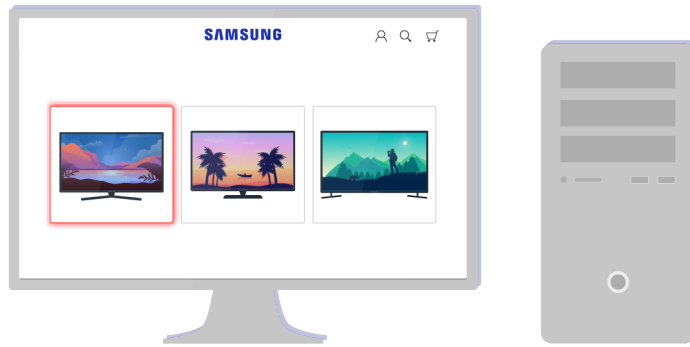

Find your TV model and download the firmware file.

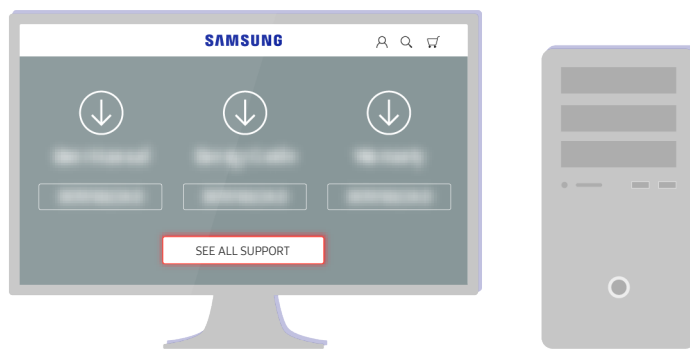

Find your TV model and download the firmware file.

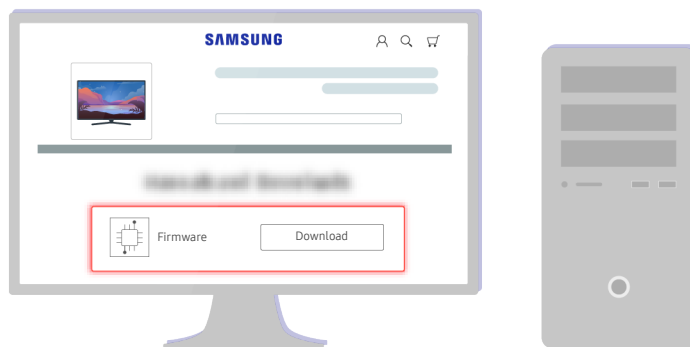

Click Download to download the firmware.



Unzip the downloaded file and store it in your USB drive top folder.



Unzip the downloaded file and store it in your USB drive top folder.



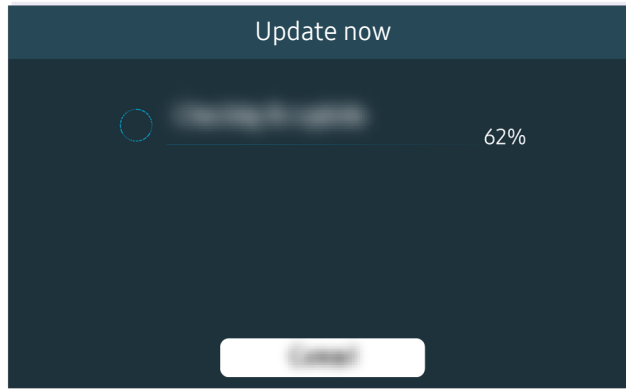

Insert the USB device into the USB slot on the back of your TV or the side of the One Connect Box.





The firmware update begins automatically. Your TV will be automatically reset when the firmware update is completed. Do not turn off your TV while the firmware update is in progress.

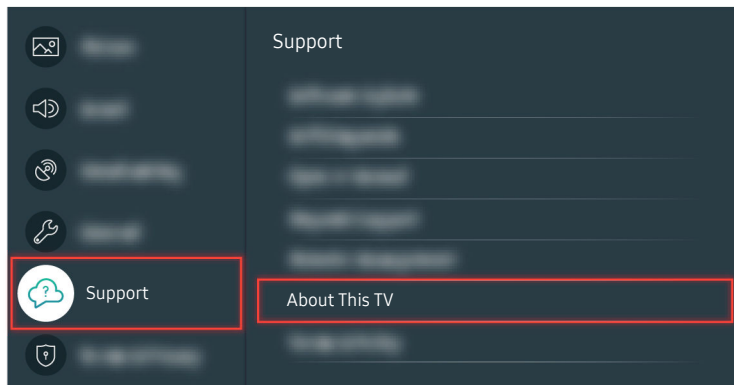

After your TV has been reset, select  >  **Settings** > **Support** > **About This TV** and check the new firmware version.



After your TV has been reset, select  >  **Settings** > **Support** > **About This TV** and check the new firmware version.

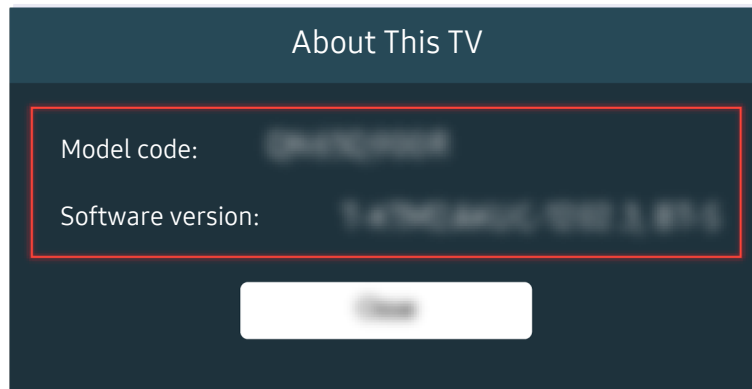

After your TV has been reset, select  >  **Settings** > **Support** > **About This TV** and check the new firmware version.

Related menu path

 >  **Settings** > **Support** > **Software Update** > **Auto update** 

 For more information in The Terrace for business, refer to the provided user manual.

 >  **Settings** > **Support** > **About This TV** 

Accessibility Guidance

Provides a menu and a remote control guide that aid the visually impaired.

Menu Learning Screen

Learn the menus on the TV screen. Once enabled, your TV will tell you the structure and features of the menus you select.

Using the Remote control

You can see the description of the buttons on the Samsung Smart Remote.

 The Samsung Smart Remote may not be supported depending on the model or geographical area.















Orientation of the Samsung Smart Remote



Hold the remote control with the buttons facing towards you. The remote is slightly thinner towards the top and thicker towards the bottom.

Description of the Samsung Smart Remote

 The images, buttons and functions of the Samsung Smart Remote may differ with the model or geographical area.





From top to bottom and left to right:

- The  or  button is at the top left.
- There is a small LED(microphone) to the right of the  or  button, but it cannot be felt by hand.
- Below the LED is a round button which is the  button.
- Of the two buttons below the  button on the Samsung Smart Remote that comes with the QLED TV, TU8 Series, The Serif, The Terrace, The Terrace for business the left one is the  button and the right one the  button.
- Of the two buttons below the  button on the Samsung Smart Remote that comes with The Sero, the left one is the  button and the right one the  button.
- Of the two buttons below the  button on the Samsung Smart Remote that comes with The Frame, the left one is the  button and the right one the  button.

- If you press the  button twice or press the  button while viewing a programme, the **Record, Timeshift, Stop** (when Record or Timeshift is running), **Info**, red, green, yellow, blue and **Move to the top** (or **Move to the bottom**) options appear.

 Select the **Move to the top** button to move the menu to the top.

 This function may not be supported depending on the geographical area.

- Underneath these two buttons are a round button and a large outer circle button. The round button is the Select button and the large outer circle button consists of 4 directional buttons (up / down / left / right).
- Underneath the directional button are three buttons, one on the left, one on the right and one in the centre. The one on the left is the  button and the one on the right is the  button. The round button in the middle is the  button.
- If you press the  button while watching a TV programme, the screen you are watching stops and a control bar appears. You can select **Rewind, Play, Pause, Fast Forward, Stop Timeshift, Record, Go to Live TV** or **Info**. You can press the up directional button to go to the playback screen and check the time that the actual broadcast programme is running and the timeshift time.

 You can use the **Slow Rewind** or **Slow Forward** functions when you select the **Pause** option.

 To use Record or Timeshift, you must connect a USB device.

 This function may not be supported depending on the model or geographical area.

- Underneath the  button are two thin horizontal buttons. These buttons protrude higher above the surface than the other buttons on the remote control. The one on the left is the volume button and the one on the right is the channel button. Push up from beneath or down from above to use these as rocker buttons to change the channel or volume.

- Briefly press the **+/-** (Volume) button to mute the sound.

- Press and hold the **+/-** (Volume) button to open the **Accessibility Shortcuts** menu.

- Briefly press the **^/∨** (Channel) button to open the **Guide**.

- Press and hold the **^/∨** (Channel) button to open the **Channel List**.

 This function may not be supported depending on the model or geographical area.

Using the accessibility menu

[View how to running the Accessibility menu functions and description of its functions.](#)

 This function may not be supported depending on the model or geographical area.

Running the Accessibility Shortcuts menu

You can turn on or turn off the accessibility functions such as [Voice Guide](#), [Picture Off](#), [Audio Description](#), [Subtitle](#), [High Contrast](#), [Enlarge](#), [Greyscale](#), [Colour Inversion](#), [Learn TV Remote](#), [Menu Learning Screen](#), [Multi-output Audio](#), [Sign Language Zoom](#), [Slow Button Repeat](#), [Accessibility Settings](#), and you can move to the [Learn TV Remote](#) and [Menu Learning Screen](#) pages.

- Samsung Smart Remote

On the Samsung Smart Remote, there are two thin horizontal rocker buttons next to each other located slightly below the middle of the remote. The one on the left is the volume button. Press and hold the volume button to open the [Accessibility Shortcuts](#) menu.

Even if the [Voice Guide](#) is set to **Off** or muted, when you press and hold the volume button, the voice guide for [Accessibility Shortcuts](#) is enabled.

 [Learn TV Remote](#) and [Menu Learning Screen](#) are only available when [Voice Guide](#) is set to **On**.

- Standard remote control



Press the AD/SUBT. button or press and hold the MUTE button to open the [Accessibility Shortcuts](#) menu.

Running the Accessibility menu functions using the General menu

 >  [Settings](#) > [General](#) > [Accessibility](#)

You can also go to the [Accessibility](#) menu from the TV settings menu. This provides more options, for example, to change the speed of Voice Guide.

The TV will not verbalize this menu unless [Voice Guide](#) is already turned on.



1. Press the  button.
2. Press the left directional button until you reach  [Settings](#).
3. Press the Select button to open the TV's [Settings](#) menu.
4. Press the down directional button to reach [General](#), and then press the Select button to open this menu.

5. Use the directional buttons to go to the [Accessibility](#) menu, and then press the Select button to open this menu.
6. The menu will appear with [Voice Guide Settings](#) as the first selection. Highlight [Voice Guide Settings](#), and then press the Select button.
7. A menu appears with the options to change [Voice Guide](#) and [Volume, Speed, Pitch, TV Background Volume](#).
8. Select the menu using the directional buttons, and then press the Select button.



Running the Accessibility menu functions using Bixby

To use Bixby, the TV must be set up and tuned and must be connected to the Internet. You can connect the TV to the Internet during the initial setup or do it later through the settings menu.

There are many commands you can say to control the TV. These can be used together with [Voice Guide](#) to give you voice input and voice output. You can use the Samsung Smart Remote but the TV must be connected to the Internet.

To speak a command, press and hold the  button (located near the top of the Samsung Smart Remote, directly below the small LED (microphone) and above the directional button) and say the command, and then release the  button. The TV will confirm the command.

For example you can:

- Turn Voice Guide on
Press the  button on the Samsung Smart Remote, and then say "Voice Guide on".
- Turn Audio Description on
Press the  button on the Samsung Smart Remote, and then say "Audio Description on".
- Turn High Contrast on
Press the  button on the Samsung Smart Remote, and then say "High Contrast on".

Learning about the Accessibility menu functions

- **Voice Guide Settings**

This function works on every screen on the TV and when turned on verbally tells you what the TV's current settings are and verbally provides details about the programme you are watching. For example, it tells you the selected volume and the current channel and gives you programme information. It also reads out the programme information from the **Guide** screen.

- **Audio Description Settings**

You can activate an audio guide that provides an audio description of video scenes for the visually impaired. This function is only available with broadcasts that provide this service.

- **Picture Off**

Turn off the TV screen and provide only sound to reduce overall power consumption. When you press a button on the remote control other than Volume and Power while the screen is off, the TV screen turns back on.

- **High Contrast**

To display all menus with an opaque black background and a white font, providing maximum contrast.

 If **High Contrast** is on, some **Accessibility** menus are not available.

- **Greyscale**

You can change the colour of the TV screen to black and white to sharpen blurred edges caused by colours.

 If **Greyscale** is on, some **Accessibility** menus are not available.

 This function may not be supported depending on the model or geographical area.

- **Colour Inversion**

You can invert the colours of the text and background displayed on the TV screen to make it easier to read the text.

 If **Colour Inversion** is on, some **Accessibility** menus are not available.

 This function may not be supported depending on the model or geographical area.

- **Enlarge**

You can enlarge important elements on the menu such as the names of programmes.

- **Learn TV Remote**

Learn the names and functions of the buttons on remote control. On this screen, pressing the power button (top left button) will turn off the TV, but when any other button is pressed the TV will say the button name and briefly tell what that button does. This teaching mode helps you to learn the location and operation of the buttons on the remote without affecting normal TV operation. Press the  button twice to exit **Learn TV Remote**.

- **Menu Learning Screen**

Learn the menus on the TV screen. Once enabled, your TV will tell you the structure and features of the menus you select.

- **Subtitle Settings**

You can view the subtitle in programmes that provide broadcast subtitles.

 In programmes that provide broadcast subtitles, the **Position** function is activated so that you can change the subtitle position.

 When watching a channel on an external device such as set-top box and cable box, turn on the subtitle function on the device. For more information, contact your service provider.

- **Multi-output Audio**

You can turn on both the TV speaker and Bluetooth headphone designed for the hearing impaired at the same time. The hearing impaired can then set the volume of their Bluetooth headphone higher than the volume of the TV speaker without affecting the volume of the TV speaker, allowing both the hearing impaired and their families to listen to the TV at comfortable sound levels.

 When you connect the Bluetooth headphone to the TV, **Multi-output Audio** is activated.

 This function may not be supported depending on the model or geographical area.

- **Sign Language Zoom Settings**

You can zoom in the sign language screen when the programme you are watching provides it.

- **Remote Button Repeat Settings**

You can configure the operation speed of the remote control buttons so that they slow down when you continually press and hold them.

Using the TV with Voice Guide on

Turn on Voice Guide that describes the menu options aloud to aid the visually impaired.

Changing channel

You can change the channel in three of ways. Every time you change channels, the new channel details will be announced. The ways to change the channel are below.

- **Channel List** (🏠 > **Live TV** > **Channel List**)

Press the 🏠 button. The Smart Hub home screen appears. Use the left or right directional buttons to move to **Live TV**, press the up directional button to move to the top row, press the directional buttons to move to **Channel List**, and then press the Select button. When **Channel List** is displayed, use the up or down directional buttons to move to the desired channel, and then press the Select button.

- **^/∨ (Channel) button**

Of the two buttons that protrude from the centre of the Samsung Smart Remote, the right one is the ^/∨ (Channel) button. Push up or pull down the ^/∨ (Channel) button to change the channel. Press the up or down of CH button on the standard remote control to change the channel.

- **Number button**

Use the 123 or 123 button on the Samsung Smart Remote to open the virtual numeric pad, enter a number, and then select **Done**. On the standard remote control, press the numeric buttons to enter a channel number.

Using on-screen number entry via the Samsung Smart Remote

Use the virtual numeric pad to enter numbers e.g. to enter a channel number or to enter a PIN.

Press the 123 or 123 button on the Samsung Smart Remote and the virtual numeric pad with 2 rows appears on screen. Voice Guide speaks “**virtual numeric pad, 6**” which indicates that the number strip is on screen and the focus is on the number 6. This strip has the following buttons:

- The top row has one option, **Done**.
- On the bottom row: From the far left: Colour pad, TTX/MIX, **More, 1, 2, 3, 4, 5, 6, 7, 8, 9, 0**, Delete, **Move to the top** (or **Move to the bottom**)

 The options that you can select in the virtual numeric pad may vary depending on the viewing mode.

Use the left and right directional buttons to move along the row, and then press the Select button to choose the numeric pad. When you have finished selecting all the numbers you need (for example, 123), press the up directional button to move to the **Done** option, and then press the Select button to finish.

When entering a channel number, you can enter the number, and then select the **Done** option on the top row or you can enter the channel number and wait. After a short while, the channel will change and the virtual numeric pad will disappear from the screen.

Changing volume

Use the **+/-** (Volume) button on the left to change the volume. Every time you change the volume, the new volume level will be announced.

- Samsung Smart Remote

Of the two buttons that protrude from the centre of the Samsung Smart Remote, the left one is the **+/-** (Volume) button. Push up or pull down the **+/-** (Volume) button to change the volume.

- Standard remote control

Press the up or down of VOL button on the standard remote control to adjust the volume.

Using programme information

When watching TV, press the Select button to view programme information which then appears at the top of the screen. Voice Guide will say programme subtitles or audio descriptions if they are available. To view more detailed programme information, press and hold the Select button. Voice Guide will say more details such as a synopsis of the programme.

Press the left or right directional button to see what you can watch next on the same channel. Press the up or down directional button to move to other channels and see which programmes are currently being broadcast on them.

Press  to go back or close the programme details.

 This function may not be supported depending on the model or geographical area.

Using the guide

See an overview of each channel's programme lineup.

When you want to know the programme information for each channel while watching a broadcast programme, press the \wedge/\vee (Channel) button on the Samsung Smart Remote. Use the directional buttons to view the programme information.

 On standard remote control, press the GUIDE button.



> Live TV > Guide

You can see the daily programme schedules for each broadcaster and programme information in the **Guide**. You can select programmes to schedule for viewing or recording.



You can also open the **Guide** using Bixby. Press and hold the  button on your Samsung Smart Remote, and then say "Guide".

 This function may not be supported depending on the model or geographical area.

 The information in the **Guide** is for digital channels only. Analogue channels are not supported.



 If the **Clock** is not set, the Guide is not provided. Set the **Clock** first. ( >  **Settings** > **General** > **System Manager** > **Time** > **Clock**)

If you need to set the clock again, follow the instructions below.

1. Press the  button to open Smart Hub.
2. Press the left directional button to move to  **Settings**.
3. Press the Select button to open the TV's **Settings** menu.
4. Use the up and down directional buttons to move to the **General** menu, and then press the Select button.
5. Use the up and down directional buttons to move to the **System Manager** menu, and then press the Select button.
6. Select the **Time** menu, and then press the Select button.
7. Select the **Clock** menu, and then press the Select button.
8. Select the **Clock Mode** menu, press the Select button, and then select **Auto** or **Manual**.

 If you select **Manual**, you can move to the **Date** or **Time** menu below to set the time or date.

When you open the **Guide**, a table grid of channels and programmes is displayed. The top row displays **Filter By : All** then the day and times. Each row has a channel name on the left and programmes on that channel on the right.

In the **Guide**, use the up and down directional buttons to move between channels and use the left and right directional buttons to move between programmes at different times within a channel. You can also use the  or  button to enter a channel number and go to that channel directly. You can use the  button to move to the programme currently broadcasting.

When you move the focus to a programme, you will hear the detailed information about the selected programme. When you move the focus to a different channel, you will hear the channel name and number and the programme details. If you move to a different day, you will hear the day announced for the first programme you reach on that day. The day is not repeated, so if you are not sure what the day is, you can move forwards and backwards 24 hours and then the day will be announced.

To view a programme on now

In the **Guide**, move to the programme currently broadcasting, and then press the Select button to go to live TV on the selected channel and programme.

Other options in the guide

In the **Guide**, move to a broadcast scheduled programme, and then press the Select button. A pop-up menu listing the functions below appears.

Use the up and down directional buttons to move within this menu, and then press the Select button to choose an item. Press  to close the menu and go back to the **Guide**.

 For the programme you are currently watching, press and hold the Select button.

- **Record**

You can record the programme that you are currently watching or a programme on another channel.

 This function may not be supported depending on the model or geographical area.

- **Stop**

You can stop the recording function that is currently running.

- **Edit Recording Time**

You can change the start and end times of scheduled programme recordings.

 This function may not be supported depending on the model or geographical area.

- **Schedule Viewing**

You can schedule the viewing of a broadcast scheduled programme.

- **Schedule Recording**

You can schedule recording of a broadcast scheduled programme.

 This function may not be supported depending on the model or geographical area.

 For more information on [Schedule Recording](#), refer to "[Recording](#)".

- **Cancel Scheduled Viewing / Cancel Scheduled Recording**

You can cancel your scheduled viewings and recordings.

 This function may not be supported depending on the model or geographical area.

- **View Details**



You can see the detailed information on the selected programme. The information may differ with the broadcast signal. If the information is not provided with the programme, nothing appears.

Press the Select button on the [View Details](#) option. This will open the details pop-up window for that programme which will display a synopsis. The details pop-up window contains detailed information and the [OK](#) option. After reading the detailed information, press the Select button on the remote control to close the pop-up window.

Using Schedule Viewing

Configure the TV to show a specific channel or programme at a specific time and date.

The  icon appears next to programmes that have been configured for a schedule viewing.

 To set up a schedule viewing, you must first set the TV's clock ( > [Settings](#) > [General](#) > [System Manager](#) > [Time](#) > [Clock](#)).

Setting up a schedule viewing

You can set up a schedule viewing on two screens.

- **The Guide Screen**

On the [Guide](#) screen, select a programme you would like to view, and then press and hold the Select button. Select [Schedule Viewing](#) on the pop-up menu that appears.

- **The Programme Info Screen**

Press the Select button while watching the TV. The Programme Info window appears. Select a broadcast scheduled programme by using the left or right directional buttons, and then press the Select button. You can schedule watching the programme by selecting [Schedule Viewing](#).

Cancelling a scheduled viewing

You have two ways to cancel a scheduled viewing.

- **Cancelling a scheduled viewing from the Guide**

In the [Guide](#) ( > [Live TV](#) > [Guide](#)), move to the programme you want to cancel scheduled viewing, and then press the Select button. Move to [Cancel Scheduled Viewing](#), and then press the Select button. When a pop-up message asking you to cancel the selected scheduled viewing appears, select [Yes](#). The selected scheduled viewing is cancelled and the screen returns to the [Guide](#) screen.

- **Cancelling a scheduled viewing from Smart Hub**

1. Press the  button to open Smart Hub, and then press the left or right directional button to move to [Live TV](#). Press the up directional button to move to the top row, and then press the left or right directional button to move to [Schedule Manager](#) or [Recordings](#).
2. Press the Select button to open [Schedule Manager](#) or [Recordings](#).

 If the TV supports the [Recordings](#) function, press the directional buttons to move to [Schedules](#).

3. Use the down directional button to move to the list of programmes scheduled to view.
4. Use the right directional button to move to the [Delete](#) option, and then press the Select button to delete the selected item.

 This function may not be supported depending on the model or geographical area.



Using the Channel List

See how to list the channels available on your TV.

 > [Live TV](#) > [Channel List](#)

Using [Channel List](#), you can change the channel or check programmes on other digital channels while watching TV.

Press the  button. The Smart Hub home screen appears. Use the left or right directional buttons to move to [Live TV](#), press the up directional button to move to the top row, press the right directional button to move to [Channel List](#), and then press the Select button. This shows a list of the channels and the programme currently on. The focus will be on the channel you are currently watching, showing channel name, channel number and programme title.

Use the up and down directional buttons to move within the channel list (or use the  button to go up and down a page at a time). You can also use the  or  button to enter a channel number and go to that channel directly.

Press the directional button in the [Channel List](#) to move to the Category list. Use the up and down directional buttons to move within this list. Press the Select button to choose a category you want from the Category list. The Category list contains [All](#), [Samsung TV Plus](#), [Favourites](#) and [Terrestrial, Cable](#) or [Satellite](#). Use the up and down directional buttons to move to a channel you want to view, and then press the Select button.

- [All](#)

Displays the channels that have been automatically searched.

 The channels received to the currently selected [Terrestrial, Cable](#) or [Satellite](#) are displayed.

 This function may differ depending on the model or geographical area.

- **Samsung TV Plus**

While the TV is connected to the Internet, you can watch popular programmes or highlights for each theme through a virtual channel at any time. As in a general channel, it provides the daily programme schedules of **Samsung TV Plus**.

 This function may not be supported depending on the model or geographical area.

- **Favourites**

Displays **Favourites 1** to **Favourites 5**. Use the up and down directional buttons to move between the lists of favourites. Highlight the one you want, and then press the Select button. The channel list will now show only the channels in this list.

- **Channel Type**

Sorts the list so that it includes channels of a selected type. However, **Channel Type** can only be used channels contain the type information.

 This function may not be supported depending on the incoming broadcast signal.

- **Sort**

Sorts the list by **Number** or by **Name**.

 This option is only available on digital channels and may not always be available.

- **Terrestrial, Cable or Satellite**

Allows you to choose between **Terrestrial**, **Cable** and **Satellite**.



 This function may not be supported depending on the incoming broadcast signal.

 This function may not be supported depending on the model or geographical area.

 This function may differ depending on the model or geographical area.

Recording

Recording a programme to an external hard drive connected via USB.



-  This function may not be supported depending on the model or geographical area.
-  Read all precautions before using the recording feature. For more information, refer to "[Before Using the Recording and Timeshift Functions](#)".

Using the instant and schedule recording options from the guide screen:



To record a programme that is on now, open the programme guide, move to the programme, and then press and hold the Select button. You will get a pop-up menu. Use the up and down directional buttons to move to **Record**. Press the Select button to record the programme. You will be returned to the programme guide. Recording automatically ends at the time when the programme ends.

To stop recording, press the down directional button while the programme being recorded is displayed. The control bar appears. Move the focus to **Stop Recording**, and then press the Select button. When a popup window appears, select **Stop**.

To record a programme that is on later, move to the programme in the **Guide**, and then press and hold the Select button. You will get a pop-up menu. Use the up and down directional button to move within this menu. Move to the **Schedule Recording**, and then press and hold the Select button. You will hear a message saying the programme has been set to record and then you will be returned to the programme guide.

The  icon is placed visually next to the programme title to show it is set to record. To find out if a programme is set to record or to cancel a scheduled recording, press the Select button on the programme. If it is already set to record, then the option on the menu will be **Cancel Scheduled Recording**. You can press the Select button to cancel the scheduled recording or just press the  button to go back to the programme guide without cancelling the recording.

Recording the programme you are watching

To display a menu for recording a programme or starting the Timeshift function, press the  button twice or press the  button, and then press the Select button while watching the programme. You can select the following functions on the menu:

- **Record**
Immediately starts to record the programme you are watching.
- **Timeshift**
Starts the Timeshift function.
- **Stop**
Stops the recording or the Timeshift function that is running.
- **Info**
Displays the details about the programme you are watching.

Scheduling recording from the programme info window

Press the Select button while viewing a programme to display the programme info window. In the programme info window, use the left and right directional buttons to select a broadcast scheduled programme, and then press the Select button. To schedule a recording for the programme, select **Schedule Recording**.

Changing the recording time

When recording a live programme you can specify how long you want to record for.

Press the down directional button to display the control bar at the bottom. Press the left or right directional buttons to move to **Edit Recording Time**, and then press the Select button. A slider scale appears and you will hear the recording time currently set. Use the left and right directional buttons to change the time, and then press the Select button. You will hear a menu that gives information about the recording time. To return to the programme you are watching, press the  button on the remote.

 The maximum recording time differs depending on the capacity of the USB device.

Viewing recorded programmes

 > [Live TV](#) > [Recordings](#) > [Recordings](#)

Open Smart Hub by pressing the  button on the remote control. Use the left or right directional button to move the focus to [Live TV](#). Press the up directional button to move to the top row, and then use the left or right directional button to move to [Recordings](#).

To play a programme, use the up and down directional buttons to move between programme titles. Press the Select button to play the programme or press the right directional button to move to a list of options. Use the up and down directional buttons to move between the options in this list. You can play, remove or delete the programme or view the programme details.

Select the [Play](#) option to play the programme. The programme will start. If you have watched part of this programme before, you will get a pop-up menu on screen allowing you to [Play](#) (from start), [Resume](#) (from where you left off) or [Cancel](#). Use the left and right directional buttons to move to the required option, and then press the Select button.

 This function may not be supported depending on the model or geographical area.

Deleting a recorded programme

To delete a recorded programme, go to the list of [Recordings](#). Use the up and down directional buttons to move to the recording you want to delete.

Press the right directional button to move to a list of 3 options. Press the down directional button to move to the [Delete](#) option, and then press the Select button.









You will be asked if you want to remove the selected item. Press the left directional button to move to the [Delete](#) button, and then press the Select button to delete the programme title. The programme will be deleted and you will be returned to the list of [Recordings](#).

Using Smart Hub

Learn how to open Smart Hub to access apps, games, movies and more.

Smart Hub

After pressing the  button on your remote control, you can surf the web and download apps with Smart Hub.

-  Some Smart Hub services are for pay services.
-  To use Smart Hub, the TV must be connected to the Internet.
-  Some Smart Hub features may not be supported depending on the service provider, language or geographical area.
-  Smart Hub service outages can be caused by disruptions in your Internet service.
-  To use Smart Hub, you must agree to the Smart Hub service agreement and the collection and use of personal information. Without giving consent, you cannot use the additional features and services. You can view the entire text of the [Terms & Privacy](#) by navigating to  > [Settings](#) > [Terms & Privacy](#).
-  If you want to stop using Smart Hub, you can cancel the agreement. To cancel the Smart Hub service agreement, select [Reset Smart Hub](#) () > [Settings](#) > [Support](#) > [Device Care](#) > [Self Diagnosis](#) > [Reset Smart Hub](#).

Press the  button on your remote. This will bring up a display with 2 rows. Try moving the focus to [Live TV](#) or another item on the bottom row. The options on the top row change depending on the item selected in the bottom row.

The buttons to the right of [Live TV](#) provide quick access to apps such as [Netflix](#) and [Prime Video](#).

-  Supported apps may vary depending on the model.

Use the left and right directional buttons to move between a menu or apps on a row and the up and down directional buttons to move between rows. Press the Select button to access a menu or apps.

When the Smart Hub home screen appears, use the left or right directional button to move the focus to [Live TV](#) or [Samsung TV Plus](#). Press the up directional button to move to the top row. You will be on the [Guide](#) item. The items in this row may include [Guide](#), [Channel List](#), [Schedule Manager](#), [Recordings](#) and others.

-  [Samsung TV Plus](#) may not be supported depending on the model or geographical area.

Using the Smart Hub Home Screen

On the leftmost part of the Smart Hub home screen is the static menu listed below. You can quickly and easily use the listed menu items to access the main TV settings or external devices, search and apps.

-  **Settings**

When the focus is moved to **Settings**, a list of quick settings icons appears above the top of the menu. You can quickly set frequently used functions by clicking the icons. You can set **e-Manual**, **Intelligent Mode**, **Picture Mode**, **Sound Mode**, **Sound Output**, **Game Mode**, **Subtitle**, **Audio Language**, **Sleep Timer**, **Network**, **Colour Tone**, **Picture Clarity**, **Digital Output Audio Format**, **Device Care** and **All Settings**.

 This function may not be supported depending on the model or geographical area.

-  **Source**

You can select an external device connected to the TV.

 For more information, refer to "[Switching between external devices connected to the TV](#)".

-  **Search**

A virtual keyboard appears on the screen and, you can search for channels, programmes, titles of movies or apps provided by the Smart Hub service.

 To use this feature, the TV must be connected to the Internet.

 This function may not be supported depending on the model.

-  **Apps**

You can enjoy a wide range of content including news, sports, weather and games by installing the corresponding apps on your TV.

 To use this feature, the TV must be connected to the Internet.

 For more information, refer to "[Using the Apps Service](#)".

-  **Ambient Mode**

You can enhance your living space with decorative content that matches the surroundings or view essential real-time information such as weather, time and news on the TV screen when you are not watching TV.

To return to the TV mode, press the  button in Ambient Mode. To shut off the TV, press the  button.

 If you use a remote control other than the Samsung Smart Remote, there may be restrictions to entering **Ambient Mode**.

 This function may not be supported depending on the model.

 For more information about the **Ambient Mode**, refer to "[Using the Ambient Mode](#)".

- **Home**

This menu appears first when you press the  button. Then you can quickly use any of [Samsung Account](#), [Notification](#) or [Privacy Choices](#).



- **Samsung Account**

Go to the [Samsung Account](#) screen to create a new account or sign out of your account.

 For more information about the [Samsung Account](#), refer to "[Using a Samsung account](#)."

- **Notification**

You can view a list of notifications for all events that occur on your TV. A notification appears on the screen when a scheduled programme is about to be broadcast or when an event occurs on a registered device.

If you move the focus to [Notification](#), and then press the Select button, a notification window appears on the right containing the following functions,  [Delete All](#) and  [Settings](#).

- **Privacy Choices**

You can view and set the privacy policy for Smart Hub and various other services.

- **Universal Guide**

Universal Guide is an app that allows you to search for and enjoy various content such as TV shows, dramas and movies in one place. **Universal Guide** can recommend content tailored to your preferences.

You can use this feature on your mobile device with the Samsung SmartThings app.

 To enjoy the content from these apps on your TV, they must be installed on the TV.

 When you watch some paid content, you may need to make a payment using their associated app.

 Some content may be restricted depending on your network conditions and your subscriptions to paid channels.

 Parental control is necessary when children use this service.

 Images may look blurry depending on the service provider's circumstances.

 This function may not be supported depending on the model or geographical area.

- ** Art**

When you are not watching TV or when the TV is turned off, you can use the [Art](#) mode function to edit image content such as artworks or photos or to display the content.

 This function is supported only in The Frame.

 For more information, refer to the provided user manual.

- ** Portrait Mode**



When you do not use The Sero, you can rotate its screen vertically to see content such as photos, images, and time display.

 This function is supported only in The Sero.

 For more information, refer to the provided user manual.

Launching the e-Manual

Open the user manual embedded in your TV.

Press the  button to open Smart Hub, press the left directional button to move to  **Settings**, and then press the Select button.

Use the up and down directional buttons to move to **Support**, and then select **Open e-Manual** to open the e-Manual.



 >  **Settings** > **Support** > **Open e-Manual**

You can view the embedded e-Manual containing information about your TV's key features.

 Alternatively, you can download a copy of the e-Manual from Samsung's website (<http://www.samsung.com>).

 Words in blue (e.g., **Internet**) indicate a menu item.

The e-Manual contains 2 rows of menu icons. Use the up and down directional buttons to move between rows and the left and right directional buttons to move within a row. Press the Select button to open the section you want to read.

The e-Manual contains a section called "Learn TV Remote" in "Accessibility Guidance". This is particularly useful for people who cannot easily see the buttons on the control or who are not clear what each button does. When you are viewing this section of the e-Manual, pressing the buttons on the remote control will not affect the TV. Note that the "Accessibility Guidance" item is only available when **Voice Guide** ( >  **Settings** > **General** > **Accessibility** > **Voice Guide Settings** > **Voice Guide**) is enabled.

Using Bixby

A guide to using Bixby to control your TV.

 This function is available only if Voice Assistant is set to Bixby. ( >  [Settings](#) > [General](#) > [Voice](#) > [Voice Assistant](#))

To use Bixby, your TV must be connected to the Internet and you must use the microphone on your Samsung Smart Remote.

To use Bixby, press and hold the  button on the Samsung Smart Remote, say a command into the microphone on the remote, and then release the button to run Bixby.

 The existing functional specifications may be changed if Bixby is updated.



Running Bixby

Press and hold the  button on the Samsung Smart Remote. Bixby is activated in the listening mode, the Bixby icon appears at the bottom of the TV screen. Say a command, and then release the button. The TV provides feedback on how it understands the command, and then performs the commanded task.

 If the TV does not understand the command, try again with more precise pronunciation.

 This function may not be supported depending on the model or geographical area.

 The supported language may differ depending on the geographical area.

 You can find a detailed description of the voice commands at [Explore Bixby](#). Press the  button. The [Explore Now](#) button appears at the bottom of the screen. Press the Select button to go to the [Explore Bixby](#) screen.