

SCIENTIFIC CALCULATOR OPERATION GUIDE

< EL-531TH Series >



SHARP®

CONTENTS

How to Operate

Read Before Using

KEY LAYOUT		3
RESET SWITCH		3
DISPLAY PATTERN		4
DISPLAY FORMAT AND DECIMAL SETTING FUNCTION		4
EXPONENT DISPLAY		5
ANGULAR UNIT		6

Function and Key Operation

ON/OFF, Entry Correction Keys		7
Data Entry Keys		8
Random		9
Modify		10
Basic Arithmetic Keys, Parentheses		11
Percent		12
Inverse, Square, Cube, xth Power of y, Square Root, Cube Root, xth Root of y		13
10 to the Power of x, Common Logarithm		14
e to the Power of x, Natural Logarithm		15
Factorials		16
Permutations, Combinations		17
Time Calculation		18
Fractional Calculations		19
Memory Calculations		20
Last Answer Memory		21
Trigonometric Functions		22
Arc Trigonometric Functions		23
Hyperbolic Functions		24
Coordinate Conversion		25
Binary, Pental, Octal, Decimal, and Hexadecimal Operations (N-Base)		26
Statistics Function		27
DATA INPUT		27
"ANS" KEYS FOR 1-VARIABLE STATISTICS		28
DATA CORRECTION		29
"ANS" KEYS FOR 2-VARIABLE STATISTICS		32

How to Operate

≈Read Before Using≈

This operation guide has been written based on the EL-531TH series. Some functions described here are not featured on other models. In addition, key operations and symbols on the display may differ according to the model.

KEY LAYOUT

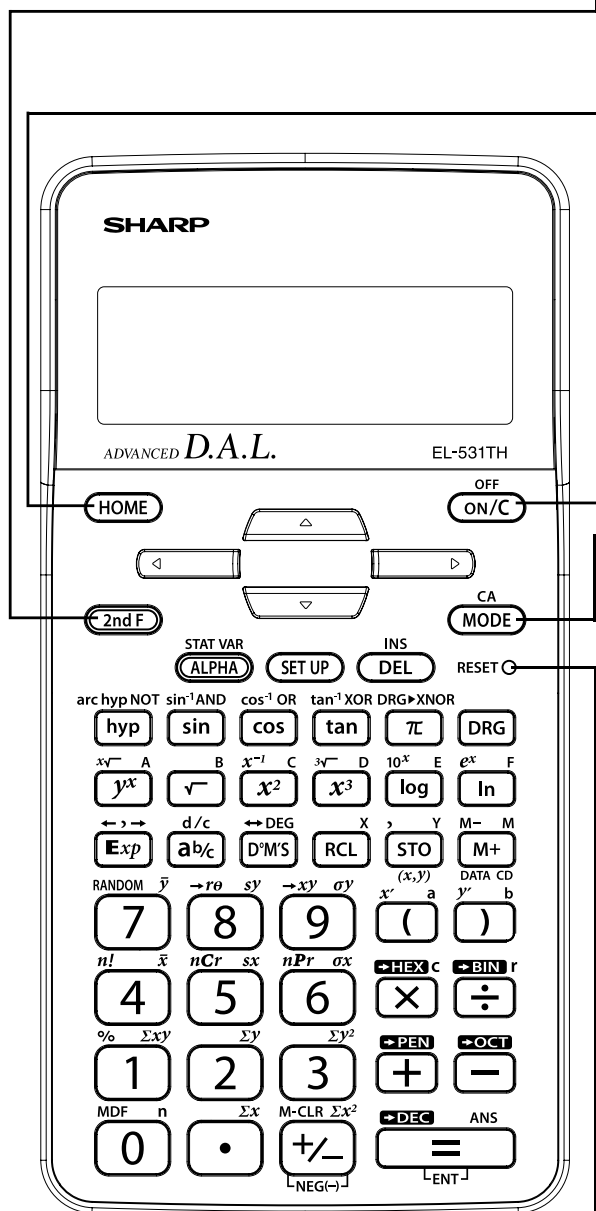

2nd function key

Pressing this key will enable the functions written in orange above the calculator buttons.

HOME key

Pressing this key will return to NORMAL mode.

ON/C, OFF key

Direct function



<Power on>

2nd function



<Power off>

Written in orange above the ON/C key

Mode key

This calculator can operate in three different modes as follows.

[Normal mode]



•Mode = 0; normal mode for performing normal arithmetic and function calculations.

[STAT-0 mode]

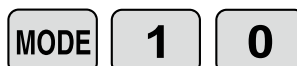

•Mode = 1; STAT-0 mode for performing 1-variable statistical calculations.

[STAT-1-6 mode]



•Mode = 1; STAT-1-6 mode for performing 2-variable statistical calculations.

When changing to the statistical sub-mode, press the corresponding number key after performing the operation to select the statistics mode (press **MODE** **1**).

1 (LINE): Linear regression calculation

2 (QUAD): Quadratic regression calculation

3 (EXP): Exponential regression calculation

4 (LOG): Logarithmic regression calculation

5 (PW R): Power regression calculation

6 (INV): Inverse regression calculation

RESET SWITCH

If the calculator fails to operate normally, press the reset switch on the front to initialise the unit. The display format and calculation mode will return to their initial settings.

NOTE:

Pressing the reset switch will erase any data stored in memory.

DISPLAY PATTERN

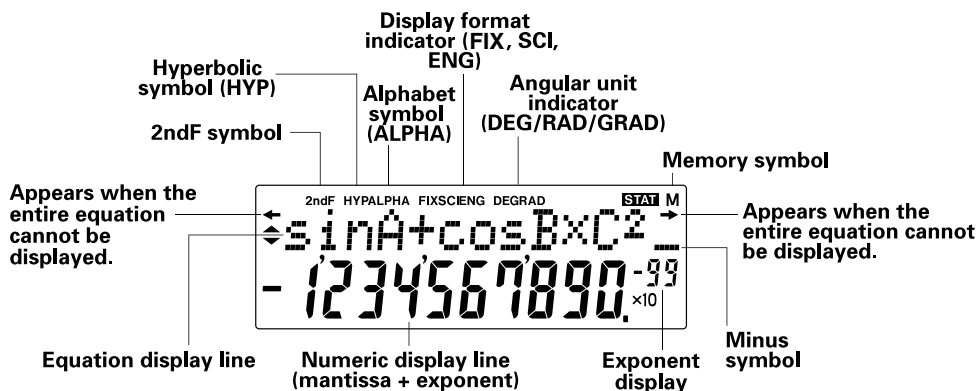

The actual display does not appear like this.
This illustration is for explanatory purposes only.

DISPLAY FORMAT AND DECIMAL SETTING FUNCTION

For convenient and easy operation, this model can be used in one of four display modes. The selected display status is shown in the upper part of the display (Format Indicator).
Note: If more 0's (zeros) than needed are displayed when the ON/C key is pressed, check whether or not the calculator is set to a Special Display Format.

- Floating decimal point format (no symbol is displayed)
Valid values beyond the maximum range are displayed in the form of a [10-digit (mantissa) + 2-digit (exponent)]
- Fixed decimal point format (FIX is displayed)
Displays the fractional part of the calculation result according to the specified number of decimal places.
- Scientific notation (SCI is displayed)
Frequently used in science to handle extremely small or large numbers.
- Engineering scientific notation (ENG is displayed)
Convenient for converting between different units.

<Example> Let's compare the display result of [10000 ÷ 8.1 =] in each display format.

(specifies normal mode)

Note: The calculator has two settings for displaying a floating point number: NORM1 (default setting) and NORM2. In each display setting, a number is automatically displayed in scientific notation outside a preset range:

- NORM1: 0.00000001 x 9999999999
- NORM2: 0.01 x 9999999999

10000 \div 8.1 =

SET UP 0 0 SET UP 1 3

Initial display

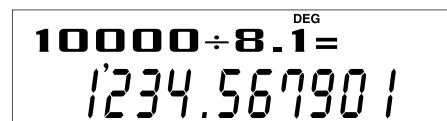

(normal mode)

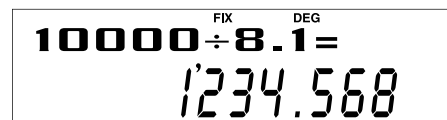

(FIX mode TAB = 3)

SET UP 0 1

SCI DEG
10000 ÷ 8.1 =
1.235⁰³_{x10}
(SCI mode)

SET UP 0 2

ENG DEG
10000 ÷ 8.1 =
1.235⁰³_{x10}
(ENG mode)

SET UP 0 3

DEG
10000 ÷ 8.1 =
1234.567901
(normal mode)

EXPONENT DISPLAY

The distance from the earth to the sun is approx. 150,000,000 (1.5×10^8) km. Values such as this with many zeros are often used in scientific calculations, but entering the zeros one by one is a great deal of work and it's easy to make mistakes. In such a case, the numerical values are divided into mantissa and exponent portions, displayed and calculated.

<Example> What is the number of electronics flowing in a conductor when the electrical charge across a given cross-section is 0.32 coulombs. (The charge on a single electron = 1.6×10^{-19} coulombs).

0.32 ÷

DEG
0.32 ÷ _
0.

1.6 Exp 19

DEG
0.32 ÷ _
1.6¹⁹_{x10}

=

DEG
0.32 ÷ 1.6E19 =
2.²⁰_{x10}

ANGULAR UNIT

Angular values are converted from DEG to RAD to GRAD with each push of the DRG key. This function is used when doing calculations related to trigonometric functions or coordinate geometry conversions.

Degrees (DEG is shown at the top of the display)

A commonly used unit of measure for angles. The angular measure of a circle is expressed as 360° .

Radians (RAD is shown at the top of the display)

Radians are different than degrees and express angles based on the circumference of a circle. 180° is equivalent to π radians. Therefore, the angular measure of a circle is 2π radians.

Grads (GRAD is shown at the top of the display)

Grads are a unit of angular measure used in Europe, particularly in France. An angle of 90 degrees is equivalent to 100 grads.

The relationships between the three types of angular units can be expressed as right:

$$\begin{aligned} 90^\circ \text{ (DEG)} &= \\ \pi/2 \text{ (RAD)} &= \\ 100 \text{ (GRAD)} &= \end{aligned}$$

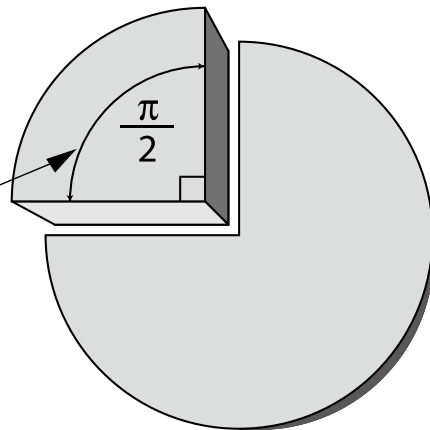

<Example> Check to confirm 90 degrees equaling $\pi/2$ radians equaling 100 grads. ($\pi=3.14159\dots$)

Operation	Display	Angular indicator
ON/C DRG DRG (Select DEG mode)	DEG 0.	
90 2ndF DRG ▶	90▶RAD 1.570796327	($\pi/2$)
2ndF DRG ▶	ANS▶GRAD 100.	
2ndF DRG ▶	ANS▶DEG 90.	

≈Function and Key Operation≈

ON/OFF, Entry Correction Keys

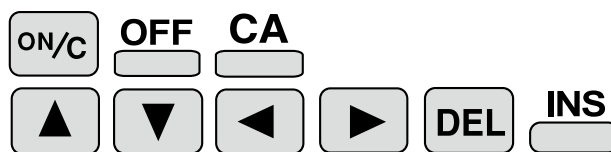

ON/C Turns the calculator on or clears the data. It also clears the contents of the calculator display and voids any calculator command; however, coefficients in 3-variable linear equations and statistics, as well as values stored in the independent memory in normal mode, are not erased.

OFF Turns the calculator off.

CA Clears all internal values, including coefficients in 3-variable linear equations and statistics. Values stored in M memory in normal mode are not erased.

▲ ▼ These arrow keys are useful for Multi-Line playback, which lets you scroll through calculation steps one by one.

◀ ▶ These keys are useful for editing equations. The **◀** key moves the cursor to the left, and the **▶** key moves the cursor to the right. The **DEL** key deletes the symbol/number at the cursor.

INS **INS** key inserts the symbol/number at the cursor.

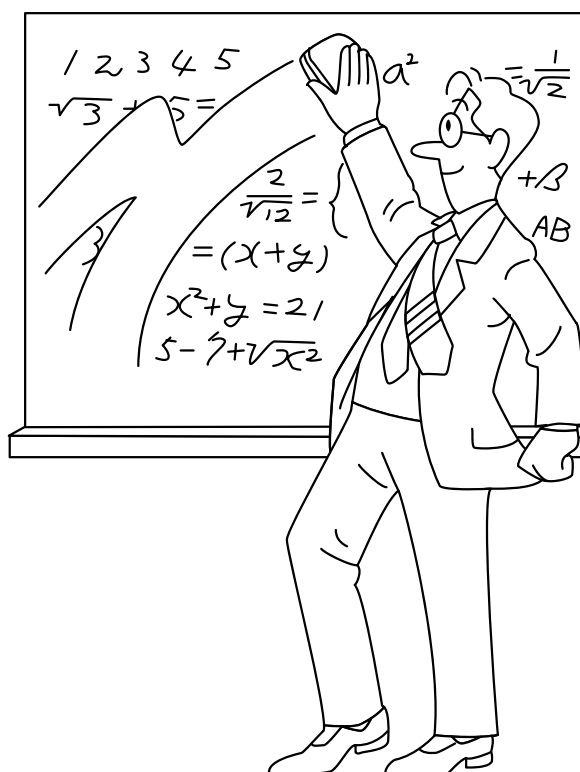

Data Entry Keys



0 to 9 Numeric keys for entering data values.



Decimal point key. Enters a decimal point.



Enters minus symbol or sign change key.
Changes positive numbers to negative and negative numbers to positive.



Enters π (3.14159...).
The constant π , used frequently in function calculations, is the ratio of the circumference of a circle to its diameter.









Pressing this key switches to scientific notation data entry.

<Example> Provided the earth is moving around the sun in a circular orbit, how many kilometers will it travel in a year?

* The average distance between the earth and the sun being 1.496×10^8 km.

Circumference equals diameter $\times \pi$; therefore,
 $1.496 \times 10^8 \times 2 \times \pi$

<u>Operation</u>	<u>Display</u>
1  496  8	<div style="border: 1px solid black; padding: 5px; text-align: center;"> <small>DEG</small> 1.496 ⁰⁸_{x10} </div>
 2   	<div style="border: 1px solid black; padding: 5px; text-align: center;"> <small>DEG</small> 1.496E08x2xπ \rightarrow 939964522. </div>

Random





RANDOM  Generates random numbers.

Random numbers are three-decimal-place values between 0.000 and 0.999. Using this function enables the user to obtain unbiased sampling data derived from random values generated by the calculator.





<Example>

    0. * * * (A random number has been generated.)

[Random Dice]

To simulate a die-rolling a random integer between 1 and 6 can be generated by pressing    . To generate the next random dice number, press .

[Random Coin]

To simulate a coin flip, 0 (heads) or 1 (tails) can be randomly generated by pressing    . To generate the next random coin number, press .

[Random Integer]

An integer between 0 and 99 can be generated randomly by pressing    . To generate the next random integer, press .

APPLICATIONS:

Building sample sets for statistics or research.

MDF

Function to round calculation results.

Even after setting the number of decimal places on the display, the calculator performs calculations using a larger number of decimal places than that which appears on the display. By using this function, internal calculations will be performed using only the displayed value.

<Example> FIX mode TAB = 1 (normal calculation)

$$5 \quad \boxed{\div} \quad 9 \quad \boxed{=} \quad 0.6 \quad (\text{internally, } 0.5555\dots)$$
$$\quad \boxed{\times} \quad 9 \quad \boxed{=} \quad 5.0$$

Rounded calculation (MDF)



$$5 \quad \boxed{\div} \quad 9 \quad \boxed{=} \quad 0.6 \quad (\text{internally, } 0.5555\dots)$$
$$\quad \boxed{2ndF} \quad \boxed{\text{MDF}} \quad (\text{internally, } 0.6)$$
$$\quad \boxed{\times} \quad 9 \quad \boxed{=} \quad 5.4$$

APPLICATIONS:

Frequently used in scientific and technical fields, as well as business, when performing chained calculations.



Basic Arithmetic Keys, Parentheses



  The four basic operators. Each is used in the same way as a standard calculator:

  + (addition), - (subtraction), x (multiplication), and ÷ (division).

 Finds the result in the same way as a standard calculator.

  Used to specify calculations in which certain operations have precedence. You can make addition and subtraction operations have precedence over multiplication and division by enclosing them in parentheses.

Percent

For calculating percentages. Four methods of calculating percentages are presented as follows.

1) \$125 increased by 10%...137.5

125 + 10 2ndF %

125+10%^{DEG}
137.5

2) \$125 reduced by 20%...100

125 - 20 2ndF %

125-20%^{DEG}
100.

3) 15% of \$125...18.75

125 × 15 2ndF %

125x15%^{DEG}
18.75

4) When \$125 equals 5% of X, X equals...2500

125 ÷ 5 2ndF %

125÷5%^{DEG}
2500.

Inverse, Square, Cube, xth Power of y, Square Root, Cube Root, xth Root of y

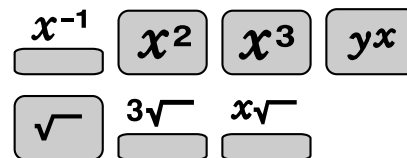

x^{-1} Calculates the inverse of the value.

x^2 Squares the value.

x^3 Cubes the value.

yx Calculates exponential values.

$\sqrt{\quad}$ Calculates the square root of the value.

$\sqrt[3]{\quad}$ Calculates the cube root of the value.

$\sqrt[x]{\quad}$ Calculates the x^{th} root of y.

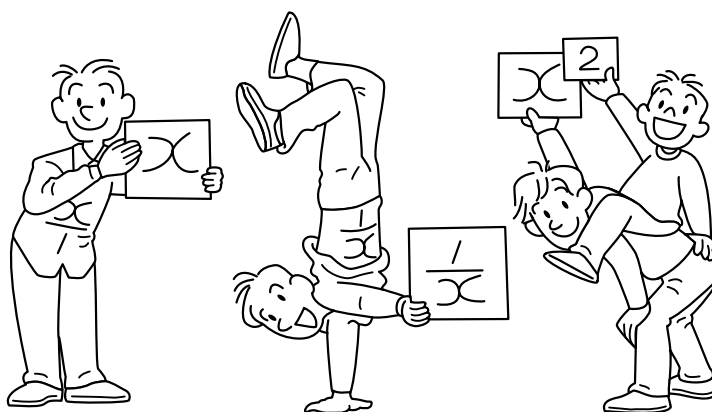

<Example>

Operation	Display
2 \times 2 \times 2 \times 2 =	2x2x2x2= ^{DEG} 16.
2 yx 4 =	2^4= ^{DEG} 16.
4 2^{ndF} $\sqrt{\quad}$ 16 =	4x√16= ^{DEG} 2.

10 to the Power of x, Common Logarithm

log

10^x

10^x

Calculates the value of 10 raised to the x^{th} power.

log

Calculates logarithm, the exponent of the power to which 10 must be raised to equal the given value.

<Example>

Operation

2ndF 10^x 3 =

log 1000 =

Display

$10^3 =$ ^{DEG}
1000.

log1000 = ^{DEG}
3.

e to the Power of x, Natural Logarithm

In

e^x



e^x

Calculates powers based on the constant e (2.718281828).

In

Computes the value of the natural logarithm, the exponent of the power to which e must be raised to equal the given value.

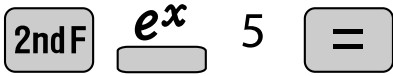
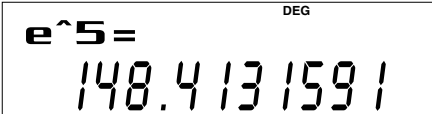
<Example>

	<u>Operation</u>	<u>Display</u>
		
		

Factorials $n!$

$n!$

The product of a given positive integer n multiplied by all the lesser positive integers from 1 to $n-1$ is indicated by $n!$ and called the factorial of n .

<Example>

Operation

7 **2ndF** $n!$ **=**

Display

7!= DEG
5040.

c.f

$n! = 1 \times 2 \times 3 \times \dots \times n$

APPLICATIONS:
Used in statistics and mathematics. In statistics, this function is used in calculations involving combinations and permutations.

Permutations, Combinations $\frac{nPr}{\text{ }} \frac{nCr}{\text{ }}$

$\frac{nPr}{\text{ }}$

This function finds the number of different possible orderings in selecting r objects from a set of n objects. For example, there are six different ways of ordering the letters ABC in groups of three letters—ABC, ACB, BAC, BCA, CAB, and CBA.

The calculation equation is ${}_3P_3 = 3 \times 2 \times 1 = 6$ (ways).

$\frac{nCr}{\text{ }}$

This function finds the number of ways of selecting r objects from a set of n objects. For example, from the three letters ABC, there are three ways we can extract groups of two different letters—AB, AC, and CB.

The calculation equation is ${}_3C_2$.

<Example>

	<u>Operation</u>	<u>Display</u>
6	$\frac{nPr}{\text{ }}$ 4 =	<div style="border: 1px solid black; padding: 5px; text-align: center;"> <small>DEG</small> 6P4= 360. </div>
6	$\frac{nCr}{\text{ }}$ 4 =	<div style="border: 1px solid black; padding: 5px; text-align: center;"> <small>DEG</small> 6C4= 15. </div>

APPLICATIONS:

Used in statistics (probability calculations) and in simulation hypotheses in fields such as medicine, pharmaceuticals, and physics. Also, can be used to determine the chances of winning in lotteries.

Time Calculation ↔DEG D°M'S



Converts a sexagesimal value displayed in degrees, minutes, seconds to decimal notation. Also, converts a decimal value to sexagesimal notation (degrees, minutes, seconds).



Inputs values in sexagesimal notation (degrees, minutes, seconds).

<Example> Convert $24^{\circ} 28' 35''$ (24 degrees, 28 minutes, 35 seconds) to decimal notation. Then convert 24.476° to sexagesimal notation.

Operation

24 D°M'S 28 D°M'S 35



Convert to decimal notation



Repeat last key operation to return to the previous display.

Display

DEG

$24^{\circ} 28' 35''$

$24^{\circ} 28' 35'' = 24.47638889$

$24.47638889 = 24^{\circ} 28' 35''$

APPLICATIONS:
 Used in calculations of angles and angular velocity in physics, and latitude and longitude in geography.

Fractional Calculations

ab/c **d/c**

ab/c

Inputs fractions and converts mutually between fractions and decimals.

d/c

Converts between mixed numbers and improper fractions.

<Example> Add $3\frac{1}{2}$ and $\frac{5}{7}$, and convert to decimal notation.

Operation	Display
3 ab/c 1 ab/c 2 +	$3\text{r}1\text{r}2 + 5\text{r}7 =$ $4\text{r}3\text{r}14.$
5 ab/c 7 =	

ab/c

$3\text{r}1\text{r}2 + 5\text{r}7 =$ 4.214285714

Convert to decimal notation

Press once to return to the previous display

2ndF **d/c**

$3\text{r}1\text{r}2 + 5\text{r}7 =$ $59\text{r}14.$

Convert to an improper fraction

Press once to return to the previous display

2ndF **d/c**

$3\text{r}1\text{r}2 + 5\text{r}7 =$ $4\text{r}3\text{r}14.$

APPLICATIONS:

There is a wide variety of applications for this function because fractions are such a basic part of mathematics. This function is useful for calculations involving electrical circuit resistance.

STO RCL M+ M-

Memory Calculations

A ~ F X Y M

- STO** Stores displayed values in memories A~F, X, Y, M.
- RCL** Recalls values stored in A~F, X, Y, M.
- M+** Adds the displayed value to the value in the independent memory M.
- M-** Subtracts the displayed value from the value in the independent memory M.
- A ~ F X Y** Temporary memories
- M** Independent memory

<Example 1> Operation

Display

0 **STO** **M**
(Enter 0 for M)

0 ⇒ **M** ^{DEG}
0.

25 **×** 27 **M+**

25x27M+ ^{DEG} ^M
675.

7 **×** 3 **M+**

7x3M+ ^{DEG} ^M
21.

RCL **M**

M= ^{DEG} ^M
696.

<Example 2>

Calculates \$/¥ at the designated exchange rate.

\$1 = ¥110

¥26,510 = \$?

\$2,750 = ¥?

Operation

Display

110 **STO** **Y**

110 ⇒ **Y** ^{DEG}
110.

26510 **÷** **RCL** **Y** **=**

26510 ÷ **Y=** ^{DEG}
241.

2750 **×** **RCL** **Y** **=**

2750 × **Y=** ^{DEG}
302'500.

Last Answer Memory

ANS

Recalls the last answer calculated by pressing 

<Example> Solve for x first and then solve for y using x.

$$x = \sqrt{2} + 3 \quad \text{and} \quad y = 4 \div x$$

Operation

 2  3 

Display

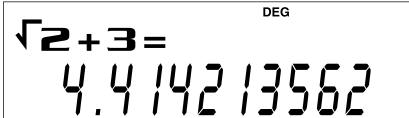
DEG
 $\sqrt{2}+3=$
4.414213562

4   **ANS**  

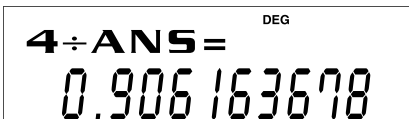
DEG
 $4 \div \text{ANS} =$
0.906163678

Trigonometric Functions

sin **cos** **tan**

Trigonometric functions determine the ratio of three sides of a right triangle. The combinations of the three sides are sin, cos, and tan. Their relations are:

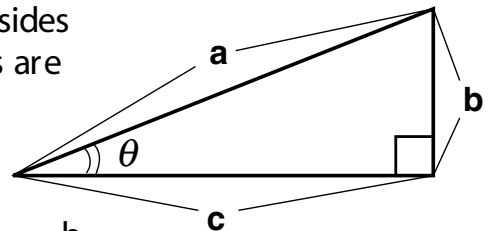

sin Calculates the sine of an angle. $\sin \theta = \frac{b}{a}$

cos Calculates the cosine of an angle. $\cos \theta = \frac{c}{a}$

tan Calculates the tangent of an angle. $\tan \theta = \frac{b}{c}$

<Example>

The angle from a point 15 meters from a building to the highest floor of the building is 45° . How tall is the building?

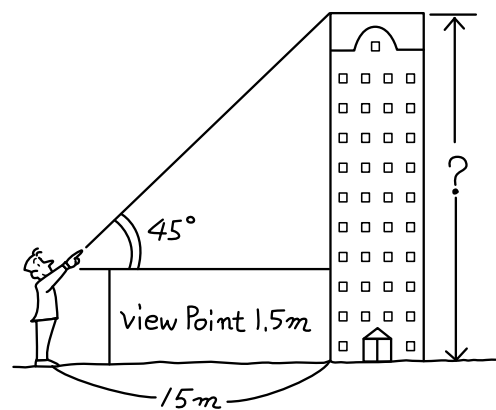

[DEG mode]

Operation		Display
tan	45 × 15	<div style="border: 1px solid black; padding: 5px; display: inline-block;"> tan45x15+1.5^{DEG} → 16.5 </div>
+	1 • 5 =	
View point		

APPLICATIONS:

Trigonometric functions are useful in mathematics and various engineering calculations. They are often used in astronomical observations, civil engineering and in calculations involving electrical circuits, as well as in calculations for physics such as parabolic motion and wave motion.

Arc Trigonometric Functions \sin^{-1} \cos^{-1} \tan^{-1}

Arc trigonometric functions, the inverse of trigonometric functions, are used to determine an angle from ratios of a right triangle. The combinations of the three sides are \sin^{-1} , \cos^{-1} , and \tan^{-1} . Their relations are;

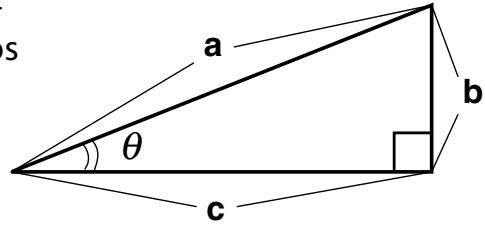

\sin^{-1} (arc sine) Determines an angle based on the ratio b/a of two sides of a right triangle.

$$\theta = \sin^{-1} \frac{b}{a}$$

\cos^{-1} (arc cosine) Determines an angle based on the ratio c/a for two sides of a right triangle.

$$\theta = \cos^{-1} \frac{c}{a}$$

\tan^{-1} (arc tangent) Determines an angle based on the ratio b/c for two sides of a right triangle.

$$\theta = \tan^{-1} \frac{b}{c}$$

<Example>

At what angle should an airplane climb in order to climb 80 meters in 100 meters?

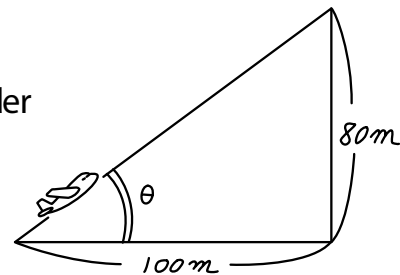

[DEG mode]

Operation

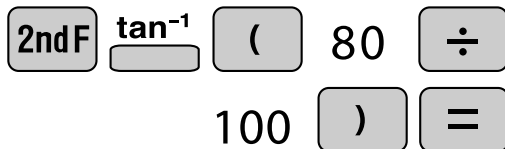

Display

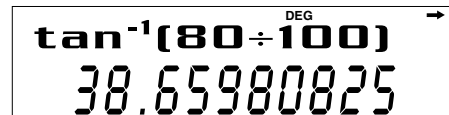

Hyperbolic Functions

hyp

arc hyp

hyp

The hyperbolic function is defined by using natural exponents in trigonometric functions.

arc hyp

Arc hyperbolic functions are defined by using natural logarithms in trigonometric functions.

APPLICATIONS:

Hyperbolic and arc hyperbolic functions are very useful in electrical engineering and physics.

Coordinate Conversion $\rightarrow r\theta$ $\rightarrow xy$, \leftarrow, \rightarrow

$\rightarrow r\theta$

Converts rectangular coordinates to polar coordinates ($x, y \rightarrow r, \theta$)

$\rightarrow xy$

Converts polar coordinates to rectangular coordinates ($r, \theta \rightarrow x, y$)

,

Splits data used for dual-variable data input.

\leftarrow, \rightarrow

Displays r, θ and x, y . ($x \rightleftharpoons y$ or $r \rightleftharpoons \theta$)

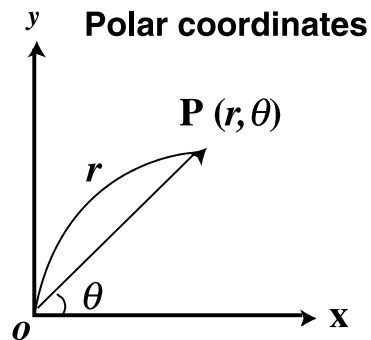
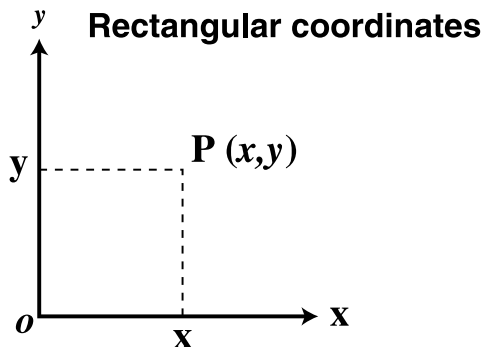

<Example> Determine the polar coordinates (r, θ) when the rectangular coordinates of Point P are ($x = 7, y = 3$).

[DEG mode]

		<u>Operation</u>			<u>Display</u>
7	<input type="text"/>	,	3	<input type="text"/>	r = 7.615773106
	<input type="text"/>	\leftarrow, \rightarrow		<input type="text"/>	theta = 23.19859051
7.6	<input type="text"/>	,	23.2	<input type="text"/>	x = 6.985428578
	<input type="text"/>	\leftarrow, \rightarrow		<input type="text"/>	y = 2.993958513

APPLICATIONS:

Coordinate conversion is often used in mathematics and engineering especially for impedance calculations in electronics and electrical engineering.

Binary, Pental, Octal, Decimal, and Hexadecimal Operations (N-Base)

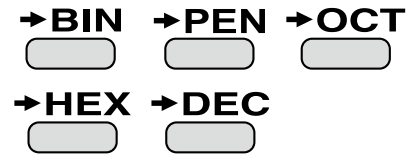

This calculator can perform conversions between numbers expressed in binary, pental, octal, decimal, and hexadecimal systems. It can also perform the four basic arithmetic operations, calculations with parentheses and memory calculations using binary, pental, octal, decimal, and hexadecimal numbers. In addition, the calculator can carry out the logical operations AND, OR, NOT, NEG, XOR, and XNOR on binary, pental, octal, and hexadecimal numbers.

- BIN**
 Converts to the binary system. "b" appears.
- PEN**
 Converts to the pental system. "P" appears.
- OCT**
 Converts to the octal system. "o" appears.
- HEX**
 Converts to the hexadecimal system. "H" appears.
- DEC**
 Converts to the decimal system. "b", "P", "o", and "H" disappear from the display.

Conversion is performed on the displayed value when these keys are pressed.

<Example 1> Operation Display

1AC

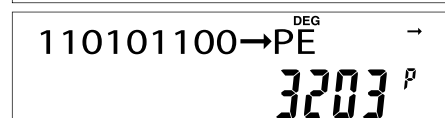
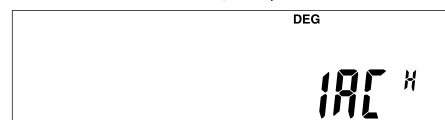

<Example 2> Operation Display

1011



101





Statistics Function

The statistics function is excellent for analyzing qualities of an event. Though primarily used for engineering and mathematics, the function is also applied to nearly all other fields including economics and medicine.

DATA INPUT

 Enters data for statistical calculations.

 Clears data input.

 Splits data used for dual-variable data input.
(Used for dual-variable statistical calculations.)

<Example 1> Here is a table of examination results. Input this data for analysis.



Data table 1

No.	1	2	3	4	5	6	7	8
Score	30	40	50	60	70	80	90	100
No. of pupils	2	4	5	7	12	10	8	2



Operation

Select single-variable statistics mode

30  2 

⋮

100  2 

Score Number of pupils

Display

Stat 0 DEG STAT
0.

DATA SET= DEG STAT
1.

DATA SET= DEG STAT
8.

"ANS" KEYS FOR 1-VARIABLE STATISTICS

- \bar{x} Calculates the average value of the data (sample data x).
- sx Calculates the standard deviation for the data (sample data x).
- σx Calculates the standard deviation of a data population (sample data x).
- n Displays the number of input data (sample data x).
- Σx Calculates the sum of the data (sample data x).
- Σx^2 Calculates the sum of the data (sample data x) raised to the second power.

NOTE:

1. Sample data refers to data selected randomly from the population.
2. Standard deviation of samples is determined by the sample data shift from an average value.
3. Standard deviation for the population is standard deviation when the sample data is deemed a population (full data).

Let's check the results based on the previous data.

- RCL** \bar{x} 69 (average value)
- RCL** sx 17.75686128 (standard deviation)
- RCL** σx 17.57839583 (standard deviation of the population)
- RCL** n 50 (total count of data)
- RCL** Σx 3450 (total)

DATA CORRECTION

Correction prior to pressing DATA immediately after a data entry: Delete incorrect data with ON/C , then enter the correct data.

Correction after pressing DATA :

Use \blacktriangle \blacktriangledown to display the data previously entered.

Press \blacktriangledown to display data items in ascending (oldest first) order. To reverse the display order to descending (latest first), press the \blacktriangle key. Each item is displayed with 'X n=', 'Y n=', or 'N n=' (n is the sequential number of the data set).

Display the data item to modify, input the correct value, then press DATA . Using (x,y) , you can correct the values of the data set all at once.

- When \blacktriangle or \blacktriangledown appears, more data items can be browsed by pressing \blacktriangle or \blacktriangledown .
- To delete a data set, display an item of the data set to delete, then press 2ndF CD . The data set will be deleted.
- To add a new data set, press ON/C and input the values, then press DATA .

<Example 2>

Data table 2

X: 30, 40, 40, 50



X: 30, 45, 45, 45, 60

Operation	Display
MODE 1 0 Select single-variable statistics mode	Stat 0 DEG STAT 0.
30 DATA	DATA SET= DEG STAT 1.
40 (x,y) 2 DATA	DATA SET= DEG STAT 2.
50 DATA	DATA SET= DEG STAT 3.

Operation



45 3



Display

◄X2= DEG STAT
40.

◄X2= DEG STAT
45.

◄N2= DEG STAT
3.

◄X3= DEG STAT
60.

APPLICATIONS:

Single-variable statistical calculations are used in a broad range of fields, including engineering, business, and economics. They are most often applied to analysis in atmospheric observations and physics experiments, as well as for quality control in factories.

<Example 3> The table below summarizes the dates in April when cherry blossoms bloom, and the average temperature for March in that same area. Determine basic statistical quantities for data X and data Y based on the data table.

Data table 3

	Year	2010	2011	2012	2013	2014	2015	2016	2017
x	Average temperature	6.2	7.0	6.8	8.7	7.9	6.5	6.1	8.2
y	Date blossoms bloom	13	9	11	5	7	12	15	7

Operation



Display



Select dual-variable statistics mode and linear regression calculation in sub-mode.

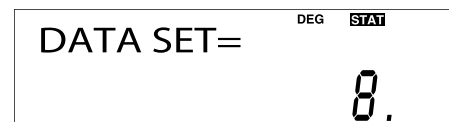
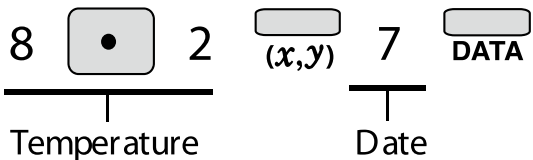
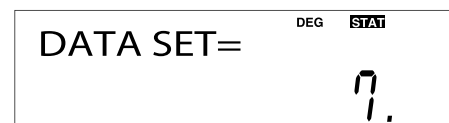
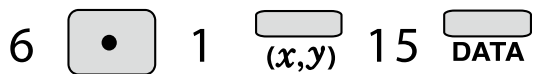
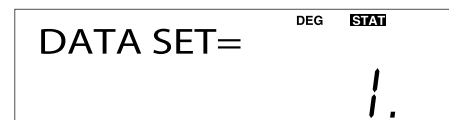
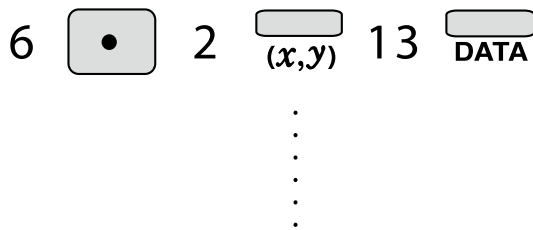

"ANS" KEYS FOR 2-VARIABLE STATISTICS

In addition to the 1-variable statistic keys, the following keys have been added for calculating 2-variable statistics.

Σxy
Calculates the sum of the product for sample data x and sample data y.

Σy
Calculates the sum of the data (sample data).

Σy^2
Calculates the sum of the data (sample data) raised to the second power.

\bar{y}
Calculates the average value of the data (sample data).

sy
Calculates the standard deviation for the data (sample data).

σy
Calculates the standard deviation of a data population (sample data).

NOTE:

The codes for basic statistical quantities of sample data x and their meanings are the same as those for single-variable statistical calculations.

Let's check the results based on the previous data.

RCL \bar{x}
7.175 (Average for data x)

RCL sx
0.973579551 (Standard deviation for data x)

RCL σx
0.91070028 (Standard deviation of the population for data x)

RCL \bar{y}
9.875 (Average for data y)

RCL sy
3.440826313 (Standard deviation for data y)

RCL σy
3.218598297 (Standard deviation of the population for data y)

RCL n
8 (Total count of data)

RCL Σx
57.4 (Sum of data x)

RCL Σx^2
418.48 (Sum of data x raised to the second power)

RCL Σxy
544.1 (Sum of the product of data x and data y)

RCL Σy
79 (Sum of data y)

RCL Σy^2
863 (Sum of data y raised to the second power)

SHARP
SHARP CORPORATION