

SHARP

androidtv

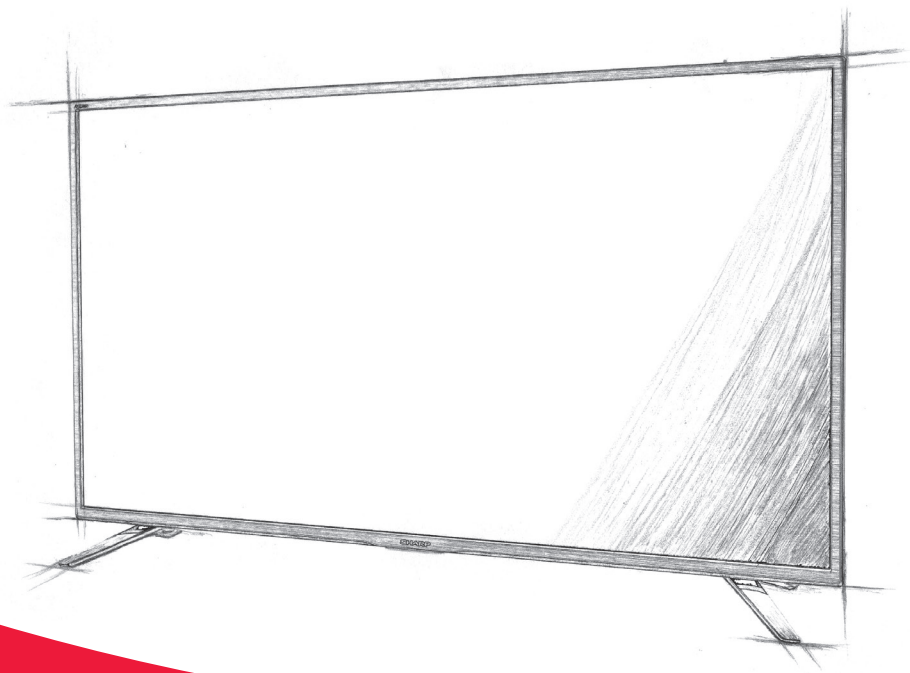

Instruction manual

Sharp Android TV

EN

Trademarks



The terms HDMI, HDMI High-Definition Multimedia Interface, and the HDMI Logo are trademarks or registered trademarks of HDMI Licensing Administrator, Inc.



The DVB logo is the registered trademark of the Digital Video Broadcasting - DVB - project.



Manufactured under license from Dolby Laboratories. Dolby, Dolby Audio, and the double-D symbol are trademarks of Dolby Laboratories Licensing Corporation.



For DTS patents, see <http://patents.dts.com>. Manufactured under license from DTS Licensing Limited. DTS, the Symbol, DTS and the Symbol together, Virtual:X, and the DTS Virtual:X logo are registered trademarks and/or trademarks of DTS, Inc. in the United States and/or other countries. © DTS, Inc. All Rights Reserved.



For DTS patents, see <http://patents.dts.com>. Manufactured under license from DTS Licensing Limited. DTS, the Symbol, DTS and the Symbol together, DTS-HD, and the DTS-HD logo are registered trademarks and/or trademarks of DTS, Inc. in the United States and/or other countries. © DTS, Inc. All Rights Reserved.



The Wi-Fi CERTIFIED Logo is a certification mark of the Wi-Fi Alliance.

androidtv





Google, Android, YouTube, Android TV and other marks are trademarks of Google LLC.





The Bluetooth® word mark and logos are registered trademarks owned by Bluetooth SIG, Inc.

Getting Started

Using the remote control

You can operate many of the TV's features by using the  /  /  and OK buttons on the remote control.

1. Use the  /  /  buttons to "focus" on the desired item.
2. Press the OK button to select the item currently in focus.

To return to the previous screen

Press the BACK button.

On-screen keyboard

There is a preinstalled on-screen keyboard app in your set which will appear whenever text is expected to be entered by the user, e.g., Wi-Fi password or website address in the web browser.

To navigate the on-screen keyboard, use the arrow buttons on the remote control, enter the character selected by pressing OK. Press and hold OK button for 2 seconds on selected symbol to invoke associated national character(s) (with accents or diacritical marks).

The Google Assistant

The Google Assistant lets you to use voice commands to quickly find and play your favourite shows, obtain answers and control your home.

Using the Google Assistant with your voice

Remote controls with the Google Assistant have a Google Assistant dedicated button and a built-in microphone. To use this feature with the Google Assistant remote control, follow the instructions as below.



1. Press the  button.
The light on the remote control will illuminate.
2. Wait for the on-screen message from the Google Assistant, then speak into the microphone.
By speaking into the microphone, you can search for various content or control your connected smart home devices.

Speech examples may be displayed on the television screen depending on your model.

When you cannot access the Google Assistant

Ensure that the remote control which has the  button on it, is paired to the TV by pressing the HOME button and selecting [Settings] — [Remotes & Accessories]

Using the Google Assistant with on-screen keyboard

1. Press the HOME button, then select  (the Google Assistant icon) from the Home menu.
2. Select icon .
3. Via on-screen keyboard, enter your question or command.

NOTE

The Google Assistant requires internet connection.

The Google Assistant is not available in certain languages and countries. The type of remote control supplied with the TV, and the availability of a remote control with a built-in microphone varies depending on your model/region/country. An optional remote control is available in some models/regions/countries.

Installing apps from the Google Play Store

You can install apps from the Google Play Store to the TV, just like you do with smartphones and tablets.

NOTE

You can only install apps that are compatible with this television. They may differ from the apps shown on smartphones/tablets. An Internet connection and Google account are required to install apps from the Google Play Store.

HINT

If you do not have a Google account or wish to create a shared account, this

can be done by accessing the following website.

<https://accounts.google.com/signup>

The website above may vary depending on your region/country. It is also subject to change without notice. For details, refer to the Google homepage. We recommend that you create a Google account on a computer or mobile device.

1. Press the HOME button, select  (Apps icon) from the Home menu, and select Google Play Store from the apps list.
If the supplied remote control has an APPS button, you can press the APPS button to display the apps list.
2. Select an app to install.
After downloading, the app is automatically installed and added. Its icon appears in the list of installed apps, allowing you to launch it.

About paid apps

There are free apps and paid apps in the Google Play Store. To purchase a paid app, a prepaid Google Play gift card code or credit card information is required. You can purchase a Google Play gift card from various retailers.

To delete an app

1. Press the HOME button, select  (Apps icon) from the Home menu, select Google Play Store from the apps list, and select My Apps.
If the supplied remote control has an APPS button, you can press the APPS button to display the apps list.
2. Select an app to be deleted, and then uninstall the app.

Alternative method

1. Press the HOME button, select  (Apps icon) from the Home menu, then press OK to open list of apps.
If the supplied remote control has an APPS button, you can press the APPS button to display the apps list.
2. Select an app to be deleted, press and hold OK button until pop-up menu appears.
3. Choose option [Uninstall] and confirm with OK.

NOTE

Free space on internal storage of the TV is limited. When storage is full, it will be not possible to install more apps. To check how much free space is available go to [Settings] — [Device Preferences] — [Storage].

If internal storage is full and you wish to install additional apps, you will have to delete some currently installed apps or move apps to USB memory device or SD card. Please refer to the chapter "Moving apps to a USB memory device or SD card".

Moving apps to a USB memory device or SD card

You can move downloaded apps to a USB memory device or SD card to increase the space available in the TV.

NOTE

When you format a USB memory device/SD card, all data saved in the device will be deleted. Back up your important data before formatting.

Performing this procedure formats the USB memory device/SD card for exclusive use with the TV. Therefore, you may be unable to use the USB memory device/SD card with a computer, etc.

Some apps cannot be moved to a USB memory device/SD card.

1. Insert SD card or USB memory device to the TV.
2. Press the HOME button, select [Settings] — [Device Preferences] — [Storage] — the desired USB memory device or SD card.
3. Format the selected memory device as an internal storage device.
4. When formatting is finished, press the HOME button, then select [Settings] — [Apps].
5. Select the app that you want to move to the USB memory device or SD card.
6. Select the USB memory device/SD card from the used storage. The app is moved to the USB memory device/SD card.

HINT

Repeat steps 4 to 6 to move additional apps to the USB memory device.

To remove a USB memory device

1. Press the HOME button, select [Settings] — [Device Preferences] — [Storage] — the desired USB memory device, and then select the option to remove it.

NOTE

The USB memory device is used only for saving apps. To use the USB memory device for other purposes, you must format it again.

If you delete an app in the USB memory device using a computer, you will be unable to launch it from the TV.

If you remove a USB memory device from the TV, you will be unable to use the apps that were moved to the USB memory device.

You cannot specify a USB memory device as the installation location of an app. First install the app on the TV as normal, and then move it to the USB memory device.

Depending on TV model, your set will be equipped with either SD card slot or Micro SD card slot. Please ensure to use the correct type of SD card, corresponding to the available slot.

Viewing Internet media

You can use video streaming services such as YouTube and Netflix to watch Internet content. The available services vary depending on your country and region. You can launch these services by selecting their tiles in the Home Menu.

NOTE

An Internet connection is required to watch Internet content.

Enjoying safe apps and video streaming services (Security & restrictions)

You can ensure safe use of the TV by setting installation restrictions on apps that are downloaded from unknown sources, or age restrictions on programmes and videos.

1. Press the HOME button, then select [Settings] — then options such as [Apps] — [Security & restrictions] or [Channel] — [Parental Controls].

NOTE

If you change the [Security & restrictions] settings, your device and personal data are more vulnerable to attack by unknown apps from sources other than Play Store. You agree that you are solely responsible for any damage to your device or loss of data that may result from using these apps.

HINT

Other separate restrictions may be available depending on the app. For details, refer to the app's Help

Home Menu

The screen displayed when you press the HOME button on the remote control is called the Home Menu. From the Home Menu, you can search for content and select recommended content, apps, and settings.

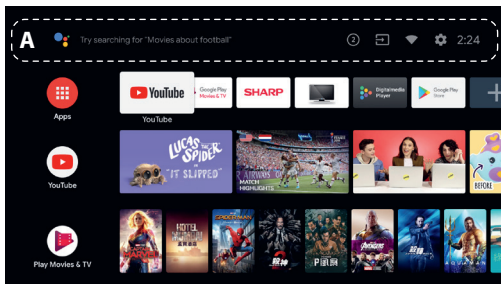
Search, Notifications, Inputs, and Settings (A)

(The Google Assistant): Use the designated Google Assistant

button on the remote control or the on-screen keyboard displayed on the TV to input keywords and search for various content.

2 (Notifications): Displayed when there are notifications such as when there is a connection issue or software update. The number indicates the number of notifications.



(Inputs): Switches the input device connected to the TV.



(Network): Configure network and internet.

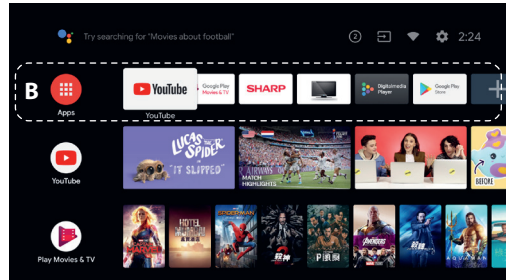

(Settings): Configure various TV-related settings.

Apps (B)

Display your favourite apps.

- If you select [Apps], a list of installed apps is displayed.
- Select [Add app to favourites] to add an app to favourites.
- If you select an added app and press and hold the OK button on the remote control, you can change the sort order or remove a favourite.
- If you select a [Live TV] app, you can watch TV broadcasts or input.

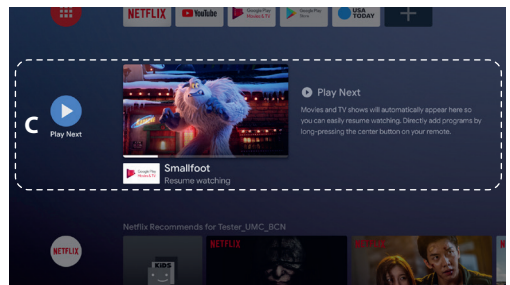
Play Next (C)

Displays what you can watch next depending on the content.

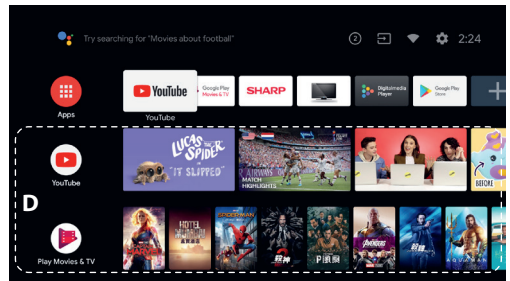
Channels (D)

The rows under Apps (B) are called "Channels". Here, you can watch recommended content from video streaming services.

HINT

You can add content to Play Next by selecting content on any channel and

pressing and holding the OK button on the remote control.

In the Home Menu, you can change the order of the rows under "Play Next (C)". Use the ▲ / ▼ buttons to move the focus to the round icon of the row you want to move, and press ◀ (or ▶ depending on the TV's display language) to be able to move the row up or down by pressing the ▲ / ▼ buttons.

Customise channels (E)

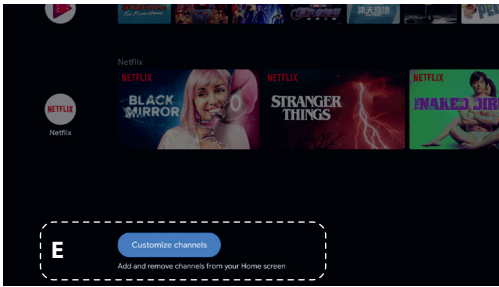

[Customise channels] is used to display or hide the selected channels.

Selecting devices that are connected to the TV

To use devices that are connected to the TV such as a Blu-ray/DVD player, or to watch TV programmes after using such devices, you must switch the input.

1. Press the SOURCE button repeatedly to select the connected device.

HINT

You can switch to your TV input by simply pressing the TV button on the remote control.

Switching from the Home Menu

1. Press the HOME button, then select the input source from [Inputs].

Accessibility features

This TV has accessibility features in [Accessibility] such as a text-to-speech function for on-screen text, zooming to make text easier to read, and subtitles.

Press the HOME button, then select [Settings] — [Device Preferences] — [Accessibility] to configure the user assistive features.

[Accessibility] has a shortcut function so you can turn it on or off by pressing and holding the BACK and ▼ buttons on the remote control for 3 seconds.

Using the TV with Other Devices

Playing content stored on a USB device

Connecting a USB device

Connect a USB storage device to the USB port of the TV to enjoy photo, music, and video files stored on the device.

(A) USB storage device

Enjoy photos/music/movies stored on a USB device

You can enjoy photos/music/movies stored on a USB device on the TV screen.

1. If the USB device connected to the TV has a power switch, turn it on.
2. Press the HOME button, select  (Apps icon) from the Home menu, and select the [DigitalMediaPlayer] from the app list. If the supplied remote control has an APPS button, you can press the APPS button to display the app list.
3. Browse the list of folders and files and select the desired file. Playback starts.

NOTE

Depending on the image dimension, file size, and number of files in a folder, some photo images or folders take time to display.

Displaying the USB device may take some time because the TV accesses the USB device every time the USB device is connected.

While accessing the USB device, do not turn off the TV or USB device and do not disconnect the USB cable. Otherwise, data stored on the USB device may be corrupted.

Depending on the file, playback may not be possible, even when using the supported formats.

Information about USB devices used for storing photos and music

- The USB ports on the TV support FAT32 and NTFS file systems.
- If your digital still camera does not work with your TV, try the following:
 - Set the USB connection settings on your camera to "Mass Storage".
 - Copy the files from the camera to a USB flash drive, then connect the drive to the TV.
- Some photos and movies may be magnified, resulting in low picture quality. Depending on the size and aspect ratio, images may not be displayed in full screen.
- It may take a long time to display a photo, depending on the file or settings.

Connecting an external devices

Use a connection method below based on the terminals available on your TV.

NOTE

The available terminals will depend on your model/region/country.

HDMI connection

For optimum picture quality, we recommend connecting your device to the TV using an HDMI cable. If your device has an HDMI jack (socket), connect it using an HDMI cable.

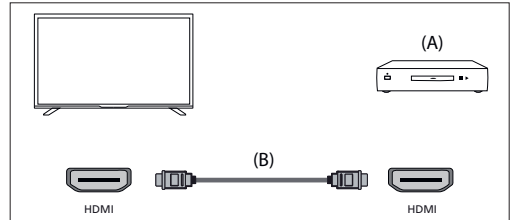

(A) External Device

(B) HDMI cable (not supplied)*

*Be sure to use an authorised HIGH SPEED HDMI cable bearing the HDMI logo.

Component video connection

If your external device player has component video jacks (sockets), connect them to the TV using a component video cable and an audio cable.

Option 1:

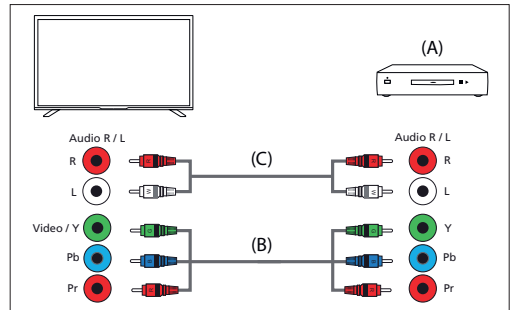

(A) External Device

(B) Component video cable (not supplied)

(C) Audio cable (not supplied)
Option 2:

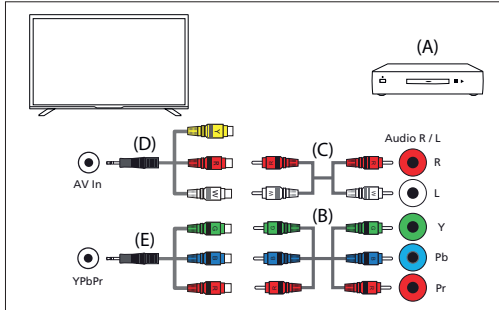

- (A) External Device
(B) Component video cable (not supplied)
(C) Audio cable (not supplied)
(D) Composite video/audio adapter cable (not supplied)
(E) Component video adapter cable (not supplied)

Composite connection

If your external device has composite jacks (sockets), connect them using a composite video/audio cable.

Option 1:

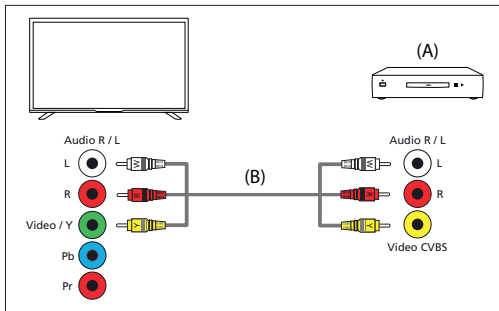

- (A) External Device
(B) Composite video/audio cable (not supplied)
Option 2:

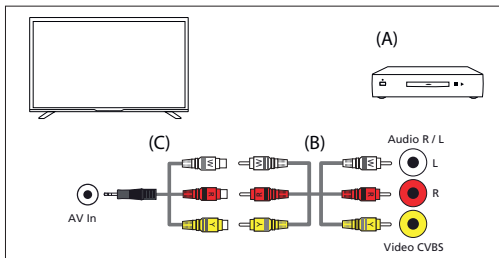

- (A) External Device
(B) Composite video/audio cable (not supplied)
(C) Composite video/audio adapter cable (not supplied)

Enjoying content from your mobile device on the TV with Chromecast built-in

Chromecast built-in allows you to wirelessly cast content from your favourite websites and apps to your TV, directly from your computer or mobile device.

1. Connect a mobile device such as a smartphone or tablet to the same home network that the TV is connected to.
2. Launch a Chromecast supported app on the mobile device.
3. Select the  (cast) icon in the app.
4. The screen of the mobile device is displayed on the TV.

NOTE

An Internet connection is required to use Chromecast built-in.

Outputting audio from an audio system

You can connect audio systems such as AV receivers or sound bars to the TV. Select a connection method below according to the specifications of the audio system you want to connect.

- Connecting with an HDMI cable (For details, carefully read "Connection using an HDMI cable" below.)
- Connecting with a digital optical cable
- Connecting with an audio cable

For connection methods, refer to the Connecting an audio system page.

NOTE

Refer to the instruction manual of the device to be connected.

Connection using an HDMI cable

This device supports Audio Return Channel (ARC). You can use an HDMI cable to output audio from audio systems that support ARC. For connection methods, refer to the Connecting an audio system page.

NOTE

The location of the HDMI terminal that supports ARC varies depending on the model. Refer to the included reference guide.

Connecting an audio system

See the illustrations below to connect an audio system such as an AV receiver or soundbar.

HDMI connection (ARC supported)

1. Connect the TV and audio system with an HDMI cable. Connect to the TV's HDMI input terminal bearing the text "ARC"

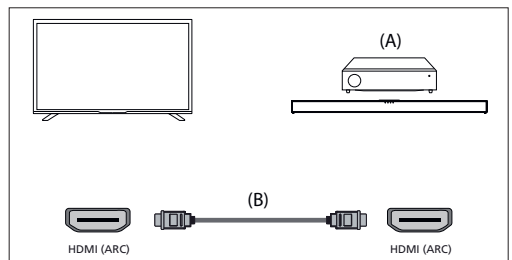

- (A) AV receiver or sound bar
(B) HDMI cable (not supplied)*

*We recommend authorised Premium High Speed HDMI Cable(s) bearing the HDMI logo.

NOTE

HDMI CEC must be enabled on your TV for this connection to work. To enable it, press the HOME button, then select [Settings] — [Device Preferences] — [Inputs] and enable option [HDMI control].

Digital optical cable connection

Connect the TV and audio system with a digital optical cable. Connect to the audio system's digital optical input terminal.

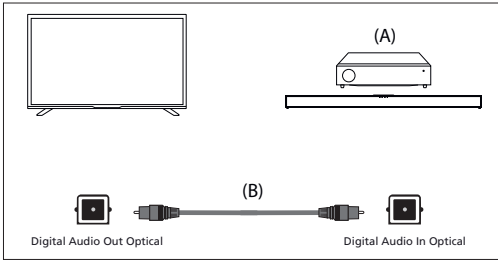

(A) AV receiver or Sound bar
(B) Optical audio cable (not supplied)

Audio cable connection

Connect the TV and audio system with a stereo to RCA analogue audio cable.

Connect to the audio system's audio input terminal.

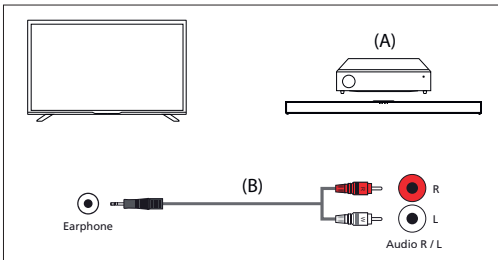

(A) AV receiver or Sound bar
(B) Audio cable (not supplied)

Adjusting an audio system

After connecting an audio system to the TV, adjust the TV's audio output from the audio system.

Adjusting an audio system connected with an HDMI cable or digital optical cable

- After connecting the TV to your audio system, press the MENU button, then select [Speakers] — [External Audio system].
- Turn on the connected audio system, then adjust the volume.

If you connect a HDMI CEC-compatible device with an HDMI connection, you can operate it by simply using the TV's remote control.

NOTE

You need to configure the [Digital Output] settings according to your audio system.

Press the HOME button, then select [Settings] — [Device Preferences] — [Sound] — [Digital Output].

If the audio system is not compatible with Dolby Digital or DTS, set [Settings] — [Device Preferences] — [Sound] — [Digital Output] to [PCM].

Adjusting an audio system connected with an audio cable

Turn on the connected audio system, then adjust the volume.

Bluetooth devices

Bluetooth function can be used to pair the TV with various devices. You can pair audio output devices such as Bluetooth soundbars, speakers or headphones. Supported input devices are Bluetooth remote controls, gamepads, computer mice etc.

To pair the TV with a Bluetooth device

- Turn the Bluetooth device on and put it in pairing mode.
To put your Bluetooth device in pairing mode, refer to the instruction manual of the device.

- Press the HOME button, then select [Settings] — [Remotes & Accessories] — [Add Accessory] to put the TV in pairing mode. A list of available Bluetooth devices will be displayed.
- Select the desired device from the list, then follow the on-screen instructions.
If you are prompted to enter a passcode, refer to the instruction manual of the device.
After pairing is completed, the device connects to the TV.

HDMI CEC-compatible devices

If a HDMI CEC-compatible device (e.g., Blu-ray player, AV receiver) is connected with an HDMI cable, you can operate the device with the TV's remote control.

Features available to compatible devices

Blu-ray/DVD player

- Automatically turns the TV on and switches the input to the connected Blu-ray/DVD player when the Blu-ray/DVD player starts to play.
- Automatically turns the connected Blu-ray/DVD player off when you turn the TV off.
- Controls menu operation (▲/▼/◀/▶ buttons), playback (e.g., ⏮ button), and channel selection of the connected Blu-ray/DVD player through the TV's remote control.

AV receiver

- Automatically turns the connected AV receiver on and switches the sound output from the TV speaker to the audio system when you turn the TV on. This function is only available if you have previously used the AV receiver to output the TV's sound.
- Automatically switches the sound output to the AV receiver by turning the AV receiver on when the TV is turned on.
- Automatically turns the connected AV receiver off when you turn the TV off.
Adjusts the volume (VOL+/- buttons) and mutes the sound (🔇 button) of the connected AV receiver through the TV's remote control.

Video camera

- Automatically turns the TV on and switches the input to the connected video camera when the camera is turned on.
- Automatically turns the connected video camera off when you turn the TV off.
- Controls menu operation (▲/▼/◀/▶ buttons), playback (e.g., ⏮ button) of the connected video camera through the TV's remote control.

NOTE

Not all devices with HDMI input/output are HDMI CEC compatible. For information about CEC compatibility, refer to the instruction manual of the device.

Adjusting HDMI CEC settings

- Turn on the connected device.
- To enable [HDMI control], press the HOME button, then select [Settings] — [Device Preferences] — [Inputs]
- Activate HDMI Control on the connected device.

Available options

[Device auto power off]

If disabled, the connected device does not turn off automatically when the TV is turned off.

[TV auto power on]

If disabled, the TV does not turn on automatically when the connected device is turned on.

[CEC Device list]

Displays the HDMI CEC device list.

Watching TV programmes

Watching TV

To watch TV programmes via Antenna, Cable or Satellite:

1. Press the HOME button, select  (Apps icon) from the Home menu, and select Live TV from the apps list.

Alternative way:

1. Press the SOURCE button and select TV.

Channel list - Broadcast

You can quickly find your preferred programmes in Channel list.

1. Press the OK button to display the Channel list.
2. Select a programme to watch.
3. Press the OK button to watch the programme.

Additional options in Channel list:

- Press the YELLOW button to get options to sort or filter channels and search channel by its number or name.
- Press the BLUE button to open Favourites list

Favourites list

To add the TV channel to Favourites List:

1. Press the MENU button and then press cursor .
2. Select [Add to My Favorites] and press OK.
3. Currently watched channel will be added to Favourites list.

Using the programme guide

Programme guide is available in Live TV mode. It provides information about forthcoming programmes. You can view the start and end time of all programmes and on all channels for the next 7 days.

Press the GUIDE button. The 7 Day programme guide will appear.

- Press the RED/GREEN button to view the previous/next day's list of programmes.
- Press the BLUE button to open [Type filter]. In the [Type filter], you can choose categories of programmes, which you are interested in (for example News, Sports etc.). Select your desired categories with cursor and press OK button to confirm selection. To leave the type filter screen, press the BLUE button again. Programmes, which belong to categories you selected, are now highlighted in the programme guide.
- Press the EXIT button to leave programme guide

Editing the channel list

To modify your list of channels:

1. Press the SOURCE button and select TV
2. Press the MENU button and go to [Settings] — [Channel] — [Channels]
3. Here choose one of menu items related to editing of channel list:

[Channel Skip]

Allows you to choose channels, which will be skipped when pressing CH+ / CH- buttons on the remote.

[Channel Sort]

Allows you to swap position of two channels between each other.

[Channel Move]

Allows you to move selected channel to new position.

[Channel Edit]

Allows you to delete channels from the channel list.

NOTE

Depending on your country settings, [Channel Sort] and [Channel Move] may be unavailable. This is caused by LCN (Logical channel number). When LCN is ON, channels are sorted by preferences of your broadcaster. To make channel sorting/moving available set LCN to OFF in [Settings] — [Channel] — [Channels] — [LCN].

Receiving terrestrial (air) digital broadcast

Before tuning terrestrial channels, ensure the TV is in antenna mode:

1. Press the HOME button, then select [Settings] — [Channel] — [Channel installation mode]

2. Select option [Antenna]

To start automatic channel scan please:

1. Press the HOME button, then select [Settings] — [Channel] — [Channels] — [Channel scan]

Receiving cable digital broadcast

Before tuning cable channels, ensure the TV is in cable mode:

1. Press the HOME button, then select [Settings] — [Channel] — [Channel installation mode]

2. Select option [Cable]

To start automatic channel scan please:

- Press the HOME button, then select [Settings] — [Channel] — [Channels] — [Channel scan]
- Configure settings for cable tuning.

[Scan Mode]

Choose way how channels will be scanned. There are 3 options: [Advance] – Insert Frequency and Network ID values provided by your cable operator.

If you set Frequency to Auto, TV will scan only predefined frequencies of operators until homing channel is found. Then based on homing channel information, remaining channels will be quickly tuned.

[Quick] – Insert Frequency and Network ID values provided by your cable operator.

If you set Frequency to Auto, TV will scan all frequencies from lowest to highest until homing channel is found. Then based on homing channel information, remaining channels will be quickly tuned.

[Full] – Slowest option for cable tuning. It will scan channels on all frequencies.

[Channel Scan Type]

Choose whether you want to tune all channels or digital channels only.

[Frequency]

Put here frequency provided by your cable operator.

If you wish to set [Frequency] to [Auto], you must delete current value in [Frequency] field via virtual keyboard and confirm.

[Network ID]

Put here Network ID provided by your cable operator.

If you wish to set [Network ID] to [Auto], you must delete current value in [Network ID] field via virtual keyboard and confirm.

Select [Scan] and press OK to start tuning

Receiving satellite digital broadcast

Before tuning satellite channels, ensure the TV is in satellite mode:

1. Press the HOME button, then select [Settings] — [Channel] — [Channel installation mode]
2. Select option [Preferred Satellite] if you want to tune one of satellites preferred in your country.
Select option [General Satellite] to get possibility to tune any satellite.

To start automatic channel scan please:

1. Press the HOME button, then select [Settings] — [Channel] — [Channels] — [Satellite Re-scan]
2. Choose the Satellite you wish to tune
3. Select [Scan] and press OK.

Connecting to a network

Connecting to a network using a LAN cable

A wired LAN connection allows you to access the Internet and your home network. Make sure to connect to the Internet or home network via a router.

1. Set up your LAN router. For details, refer to the instruction manual of your LAN router.
2. Connect LAN cable from router to the TV.
After connecting LAN cable, TV should connect to the internet automatically if DHCP is activated on your router.
In case you set up on the router static IP address for the TV, you will need to follow these steps:

1. Press the HOME button, then select [Settings] — [Network & Internet] — [IP settings] — [Static]
2. Now follow the on-screen instructions and fill in correct IP Address, Gateway, Network prefix length and DNS.

Connecting to a network using a wireless connection

The built-in wireless LAN device allows you to access the Internet and enjoy the benefits of networking in a cable-free environment.

1. Set up your wireless router. For details, refer to the instruction manual of your wireless router.
2. Press the HOME button, then select [Settings] — [Network & Internet].
3. From the list of available networks choose your wireless network. If you do not see your Wi-Fi network, select [See all] option to show the complete list of all available networks.
4. On the virtual keyboard enter password of your network

To turn off the built-in wireless LAN

To disable built-in WiFi, press the HOME button, then select [Settings] — [Network & Internet] — [Wi-Fi].

Live TV menu

Source

To get to the Live TV menu, press the SOURCE button and select one of available inputs. Then press the MENU button. Source menu allows you to switch between inputs/connections.

NOTE

Available connections depends on the TV model.

Picture Mode

To get to the Live TV menu, press the SOURCE button and select one of available inputs. Then press the MENU button. This menu provides options to modify picture quality.

Available options

[User]

Allows you to change the picture settings to your personal preference. These settings are saved automatically.

[Standard]

Standard settings.

[Vivid]

Enhances picture saturation and sharpness.

[Sport]

Optimises picture quality for viewing sports.

[Movie]

Picture has less colour and is darker.

[Game]

Recommended settings for gaming. The TV will turn off all picture post processing functions to achieve minimal input delay.

[Energy Saving]

Power saving mode, which reduces the energy used by up to 20% (by reducing the power to the LED/LCD panel). In this mode, the brightness of the picture may be reduced.

NOTE

Depending on TV model, some picture mode options may not be available.

Display Mode

To get to the Live TV menu, press the SOURCE button and select one of available inputs. Then press the MENU button.

This menu provides options to change picture aspect ratio of current source.

Available options

[Automatic]

Automatically displays the best picture format so the picture is in the correct position. Black lines may appear at the top/bottom and/or sides.

[Super Zoom]

Displays a 4:3 picture at a 16:9 size; the picture is stretched horizontally and vertically and its left and right edges are enlarged. This crops out some of the top and bottom of the picture.

[4:3]

Displays a 16:9 picture at a 4:3 size; the picture is shortened horizontally. Sidebars appear on both edges of the screen.

Displays the 4:3 picture in its original size. Side bars are shown to fill the 16:9 screen.

[Movie Expand 14:9]

Displays a 4:3 picture at a 14:9 size; the picture is stretched horizontally and vertically. This crops out some of the top and bottom of the picture. Sidebars appear on both edges of the screen.

[Movie Expand 16:9]

Displays a 4:3 picture at a 16:9 size; the picture is stretched horizontally and vertically. This crops out some of the top and bottom of the picture.

[Wide Screen]

Displays a 16:9 picture that is stretched horizontally and vertically.

Displays a 4:3 picture that is stretched out of proportion to fill the screen.

[Full]

Displays a picture in the full screen mode. 16:9 signal will be displayed in original proportion. Other picture formats will be stretched to fill the screen.

[Unscaled]

Displays a picture in its original resolution in the middle of screen. If the picture has lower resolution than the TV, there will be black bars on all four sides of the picture.

Speakers

To get to the Live TV menu, press the SOURCE button and select one of available inputs. Then press the MENU button.

Switch between speakers.

[TV Speakers]

Audio will come from the TV.

[External Audio System]

Audio will come from the external audio device (e.g., soundbar, AV receiver) when connected via one of the digital audio outputs.

Power

To get to the Live TV menu, press the SOURCE button and select one of available inputs. Then press the MENU button.

Changes the settings related to power consumption.

Available options

[Sleep Timer]

Lets you set the sleep timer so the television automatically switches off after a set amount of time.

[Picture off]

Allows you to turn off display. To turn display back on, press the STANDBY button on the remote control.

[Switch Off Timer]

Controls the amount of time the set will continue to operate without any buttons being pressed on the set or remote control before going into standby.

[No Signal Auto Power Off]

Controls the amount of time the set will continue to operate without any buttons being pressed while switched on input, which does not receive signal.

CI Card

To get to the Live TV menu, press the SOURCE button and select one of available inputs. Then press the MENU button.

Pay per view services require a "smartcard" to be inserted into the TV. If you subscribe to a pay per view service the provider will issue you with a 'CAM' and a "smartcard". The CAM can then be inserted into the COMMON INTERFACE PORT (CI Card In). This menu allows you to view information and change settings of CAM.

Advanced Options

To get to the Live TV menu, press the SOURCE button and select one of available inputs. Then press the MENU button.

Various settings for Live TV.

Available options

[Sound Tracks]

Allows you to choose between the audio channels being transmitted on Digital Television.

[Blue Mute]

Changes the background colour to blue when there is no input signal.

[Default Channel]

Allows you to choose default Digital TV channel, which will be displayed after TV is powered on.

[HBBTV Settings]

Allows the user to switch HbbTV on/off. To use HbbTV, TV must be connected to the internet and watched channel must support HbbTV service.

[Subtitle]

Select your preferred subtitle language and type.

[Teletext]

Select language for teletext.

[OAD]

Allows you to set automatic software upgrade via OAD (On Air Download) on/off.

[Auto Sleep]

Controls the amount of time the set will continue to operate without any buttons being pressed on the set or remote control before going into standby.

[System Information]

Allows you to view signal frequency, signal quality and signal strength of current Digital TV channel.

[Version Info]

Information about TV software version.

Settings menu

Network & Internet

To get to the Settings menu, press the HOME button, then select [Settings].

Available options**[Wi-Fi]**

Allows you to enable/disable built-in WiFi.

[See all]

Shows full list of available wireless networks.

[Add new network]

Allows you to add Wi-Fi network manually. This is needed in case you set up on your router invisible/hidden wireless network.

[Scanning always available]

Some location apps need to periodically scan other Wi-Fi devices in the area. This function allows to scan Wi-Fi devices even in case Wi-Fi is turned off.

[Wol]

Allows the set to turn on via network control wirelessly.

[Wol]

Allows the set to turn on via network control over LAN connection.

[Proxy Settings]

Configure proxy server for web browser.

[IP settings]

Configure wired network.

Channel

To get to the Settings menu, press the HOME button, then select [Settings].

Configures the settings related to receiving broadcast programming.

Available options**[Channels] [Antenna mode]**

[Channel Scan]

Allows you to retune the television for all digital and analogue channels.

[Update Scan]

Tunes all frequencies, on which there are currently not tuned any channels. It is recommended when searching new channels which were added recently, without retuning all channels.

[Analog Manual Scan]

Direct tuning of analogue stations.

[Single RF Scan]

Allows you to manually tune your digital signal by selecting the channel number.

[Manual Service Update]

Channel positions, names and frequencies will be updated by the provider.

[LCN]

Logical Channel Number. When turned on, digital stations will be ordered

according to provider preferences.

[Channel Scan Type]

Settings for [Channel Scan]. You can select what type of channels should be tuned: Only encrypted channels, only free channels, or all channels.

[Channel Store Type]

Settings for [Channel Scan]. You can select what type of channels should be stored after tuning finish: Only digital TV channels, only radio channels, or all channels.

[Favorite Network Select]

In some countries/areas may be available more networks. Channels will be ordered differently according to selected network.

[Channel Skip]

Allows you to choose channels, which will be skipped when pressing CH+ / CH- buttons on the remote.

[Channel Sort]

Allows you to swap position of two channels between each other.

[Channel Move]

Allows you to move selected channel to new position.

[Channel Edit]

Allows you to delete channels from the channel list.

[Analog Channel Fine-tune]

Allows you to fine-tune analogue channels to adjust picture quality.

[Channels] [Cable mode]

[Channel Scan]

Allows you to retune the television for all digital and analogue channels.

[Single RF Scan]

Allows you to manually tune your digital signal by selecting the channel number.

[LCN]

Logical Channel Number. When turned on, digital stations will be ordered according to provider preferences.

[Channel Scan Type]

Settings for [Channel Scan]. You can select what type of channels should be tuned: Only encrypted channels, only free channels, or all channels.

[Channel Store Type]

Settings for [Channel Scan]. You can select what type of channels should be stored after tuning finish: Only digital TV channels, only radio channels, or all channels.

[Channel Skip]

Allows you to choose channels, which will be skipped when pressing CH+ / CH- buttons on the remote.

[Channel Sort]

Allows you to swap position of two channels between each other.

[Channel Move]

Allows you to move selected channel to new position.

[Channel Edit]

Allows you to delete channels from the channel list.

[Analog Channel Fine-tune]

Allows you to fine-tune analogue channels to adjust picture quality.

[Channels] [Satellite mode]

[Satellite Re-Scan]

Allows you to scan selected satellite.

[Satellite Add]

Allows you to add new Satellite into the list of satellites.

[Satellite Update]

Tunes all frequencies, on which there are currently not tuned any satellite channels.

[Satellite Manual Tuning]

Allows you to scan selected satellite transponder.

[Channel Skip]

Allows you to choose channels, which will be skipped when pressing CH+ / CH- buttons on the remote.

[Channel Sort]

Allows you to swap position of two channels between each other.

[Channel Move]

Allows you to move selected channel to new position.

[Channel Edit]

Allows you to delete channels from the channel list.

[Clear Channel List]

Allows you to delete all tuned channels.

[Channel Installation Mode]

Set the type of Digital TV signal you receive. This setting affects content of [Channels] menu.

[Auto Channel Update]

If this option is set to ON, channel positions, names and frequencies will be

periodically updated by the provider. This may cause issues if you ordered channels in the list of channels by yourself. In such case we recommend to keep this option off.

[Channel Update Message]

Notifications about changes done by [Auto Channel Update] function.

[Parental Controls]

Set the parental guidance level, and block channels or inputs.

[Channels Blocked]

Set manually, which channels will be blocked, independent on age restrictions.

[Program Restrictions]

Set the channels blocking based on age/rating.

[Inputs Blocked]

Allows you to block specified inputs.

[Change PIN]

Allows you to change the PIN, needed to access blocked content.

[Audio Channel]

Allows you to change preferred audio track of current analogue channel, in case more than one audio track is available.

Accounts & Sign In

To get to the Settings menu, press the HOME button, then select [Settings].

In this menu you can add, synchronize or remove your Google account.

You can use your account for:

- Google Play Store
- Google Play Movies & TV
- Google Play Games
- YouTube

Add a new account

You can have one or more Google Accounts on your device at a time.

Sign in via Android phone:

1. Select [Add account].
2. Select [Sign In].
3. Select [Use your phone or computer].
4. To sign in, follow the on-screen instructions.
5. Your phone account will be added to the TV

Sign in manually, by entering account address/password via on-screen keyboard:

1. Select [Add account].
2. Select [Sign In].
3. Select [Use your remote].
4. To sign in, enter your email address and password.

After you add your account, you'll see «Success» on the TV screen.

Manage your account

You can sync devices, apps, and remove accounts from your Android TV.

1. Select an account you wish to manage.
2. Choose one of the following:
 - [Sync now]
 - [Remove account]
 Choose apps to sync

NOTE

For most operations in this menu, TV must be connected to the internet.

To sign in with your Android phone, TV and phone must be connected to the same Wi-Fi network.

Apps

To get to the Settings menu, press the HOME button, then select [Settings].

Menu for managing your apps. You can view apps details, delete apps, or move them to connected storage device.

Available options

[See all apps]

Shows complete list of all installed apps. By selecting app with cursor and confirming by OK, you will get to the app settings with all available actions for this app.

[App permissions]

You can check the list of app permissions categorized by TV function and

change permission settings for each app.

[Special app access]

Additional special permissions for apps, like displaying apps over other apps, access to notifications or certain directories.

Device Preferences

To get to the Settings menu, press the HOME button, then select [Settings].

Available options

[About]

Information about TV and software.

[Date & Time]

Adjusts system time & date.

[Timer]

Setup of timers for automatic TV start or power off.

[Language]

Selects the menu language. The selected menu language will also set by the voice recognition language.

[Keyboard]

Configures the on-screen keyboard.

[Inputs]

Configure Source menu and HDMI CEC.

[Power]

Changes the settings related to power consumption.

[Picture]

Adjusts the picture and screen display settings such as screen brightness.

[Sound]

Adjusts the sound settings and speaker-related options.

[Storage]

Changes the settings related to data storage.

[Home Screen]

Customises channels displayed in the [Home screen] and sorts apps.

[Store mode]

Activates shop demonstration mode.

[Google]

Configures the settings related to the search function.

[Chromecast built-in]

Displays information about the Chromecast feature.

[Screen saver]

Configures the settings of the screen saver.

[Location]

Configures the location settings to acquire the user location.

[Usage & Diagnostics]

When turned on automatically sends diagnostic information to Google.

[Security & Restrictions]

Configures the security settings such as passwords.

[Accessibility]

Configures the settings of accessibility features and services for helping users navigate their devices more easily.

[Reset]

Resets TV to factory settings. All accounts will be removed from TV, all apps will be deleted as well as all Wi-Fi/LAN settings, and all system settings will return to default values.

Remotes & Accessories

To get to the Settings menu, press the HOME button, then select [Settings].

Remotes & Accessories menu allows you to pair Bluetooth devices with your TV.

To pair your Sharp Bluetooth remote with voice control:

1. Press the HOME button, then select [Settings] — [Remotes & Accessories]
2. To pair remote with TV, follow on-screen instructions
3. On TV screen will appear name of your remote. Press OK to confirm pairing.

To pair other Bluetooth devices:

1. Press the HOME button, then select [Settings] — [Remotes & Accessories]
2. Put Bluetooth device into pairing mode. For details, refer to the instruction manual of your device.
3. On TV screen will appear name of your device. Select it with remote control and confirm with OK.

Remote control

Remote Control Parts Description

⏻ STANDBY – Switch on the TV when in standby or vice versa. By long pressing of this button, the set will display a menu offering power down option to energy saving standby mode.

SOURCE – To display the input/source menu.

NUMBER BUTTONS – 0–9 to select a TV channel directly.

🔇 MUTE – Mute the sound or vice versa.

GUIDE – Opens the 7 day TV guide (digital TV mode).

VOL (+/-) – To increase/decrease the sound level.

The Google Assistant – Use your voice to access entertainment, control smart devices, get answers on screen, and more.

HOME – Display the TV Home Menu.

CH (+/-) – To increase or decrease the channel being watched.

MENU – Display LIVE TV menu. This button works only in sources (TV, HDMI, Component, etc.). It will not work in the Home Menu.

INFO – Press once for now/next channel information.

(↶/↷/↵/OK) – Allows you to navigate the on-screen menus and adjust the system settings to your preference.

BACK – To go back a previous step.

EXIT – To exit all menus.

NETFLIX – Access the Netflix App.

Prime video – Access the Prime video App.

YouTube – Access the YouTube App.

Google Play Movies & TV – Access the “Google Play Movies & TV” online service.

MTS – Opens audio track menu.

TEXT – To enter/exit teletext.

SUB – To switch the dialogue at the bottom of the screen (on/off).

TV – To switch to Live TV.

▶| – To play/pause media

⏮ – To play in fast rewind mode

⏭ – To play in fast forward mode

■ – To stop the playback

COLOUR BUTTONS – Execute corresponding function at that time.

Configuring the TV

Date & time

Press the HOME button, then select [Settings] — [Device Preferences] — [Date & Time].

Available options

[Automatic date & time]

Turn on to synchronise the time to the incoming digital television signal. If connected to the internet, the clock will be updated from here. Turn off to set the clock manually.

[Set date]

Allows you to set date manually.

This option is available only if option [Automatic date & time] is off.

[Set time]

Allows you to set time manually.

This option is available only if option [Automatic date & time] is off.

[Set Time Zone]

Adjustment of the time offset.

[Use 24-hour format]

You can choose between 12-hour and 24-hour format for displaying time.

NOTE

Ensure you have set correct date and time. Some apps will not work if you have incorrect date and/or time.





SHA/MAN/0504



Sharp Consumer Electronics Poland sp. z o.o.
Ostaszewo 57B, 87-148 Łysomice, Poland
Assembled in Poland

www.sharpconsumer.eu

SHARP