



Questo manuale d'istruzione è fornito da trovaprezzi.it. Scopri tutte le offerte per [Smeg BCC01BLMEU Nero](#) o cerca il tuo prodotto tra le [migliori offerte di Macchine da Caffè](#)

[trovaprezzi.it](#)

Questo manuale d'istruzione è fornito da trovaprezzi.it. Scopri tutte le offerte per [Smeg BCC01BLMEU](#) o cerca il tuo prodotto tra le [migliori offerte di Macchine da Caffè](#)

**MANUALE D'USO**  
MACCHINA DA CAFFÈ AUTOMATICA

IT

**USER MANUAL**  
BEAN TO CUP COFFEE MACHINE

EN

**MANUEL DE L'UTILISATEUR**  
MACHINE À CAFÉ AUTOMATIQUE

FR

**GEBRAUCHSANLEITUNG**  
AUTOMATISCHE KAFFEEMASCHINE

DE

**GEBRUIKSAANWIJZING**  
AUTOMATISCH KOFFIEZETAPPARAAT

NL

**MANUAL DE USO**  
MÁQUINA DE CAFÉ AUTOMÁTICA

ES

**MANUAL DE USO**  
MÁQUINA DE CAFÉ AUTOMÁTICA

PT

**BRUKSANVISNING**  
AUTOMATISK KAFFEMASKIN

SV

**РУКОВОДСТВО ПО ЭКСПЛУАТАЦИИ**  
АВТОМАТИЧЕСКАЯ КОФЕМАШИНА

RU

**BRUGSANVISNING**  
AUTOMATISK KAFFEMASKINE

DA

**INSTRUKCJA OBSŁUGI**  
AUTOMATYCZNY EKSPRES DO KAWY

PL

**KÄYTTÖOHJE**  
AUTOMAATTINEN KAHVINKEITIN

FI

**BRUKSANVISNING**  
AUTOMATISK KAFFEMASKIN

NO

كتيب الاستخدام  
ماكينة تحضير القهوة

AR

**smeg**

Consigliamo di leggere attentamente questo manuale, che riporta tutte le indicazioni per mantenere inalterate le qualità estetiche e funzionali dell'apparecchio acquistato.

Per ulteriori informazioni sul prodotto: [www.smeg.com](http://www.smeg.com)

We advise you to read this manual carefully, as it contains all the instructions for managing the appliance's aesthetic and functional qualities.

For further information on the product: [www.smeg.com](http://www.smeg.com)

Nous conseillons de lire attentivement ce manuel, qui comprend toutes les indications pour maintenir inaltérées les qualités esthétiques et fonctionnelles de l'appareil acheté.

Pour obtenir des informations supplémentaires sur le produit : [www.smeg.com](http://www.smeg.com)

Wir empfehlen, diese Bedienungsanleitung, die sämtliche Anweisungen enthält, um das Aussehen und die Funktionsfähigkeit des Geräts zu erhalten, sorgfältig zu lesen.

Für weitere Informationen über das Produkt wird auf [www.smeg.com](http://www.smeg.com) verwiesen

We adviseren om deze handleiding aandachtig door te lezen. Ze bevat aanwijzingen die nodig zijn om de esthetische en functionele eigenschappen van het gekochte apparaat intact te houden.

Bezoek voor meer informatie over het product: [www.smeg.com](http://www.smeg.com)

Aconsejamos leer atentamente este manual que contiene todas las indicaciones para mantener inalterada la calidad estética y funcional del aparato adquirido.

Más información sobre el producto en: [www.smeg.com](http://www.smeg.com)

Aconselhamos que leia atentamente este manual, que refere todas as indicações para manter inalteradas as qualidades estéticas e funcionais do aparelho comprado.

Para mais informações sobre o produto: [www.smeg.com](http://www.smeg.com)

Vi rekommenderar att ni nogga läser denna handbok som anger alla de nödvändiga anvisningarna för att bibehålla den inköpta apparatens utseende och funktioner.

För mer information om produkten: [www.smeg.com](http://www.smeg.com)

Мы рекомендуем вам внимательно прочитать данное руководство, в котором приводятся все указания, необходимые для поддержания неизменными эстетических и функциональных свойств приобретенного прибора.

Дополнительную информацию об изделии можно получить на сайте: [www.smeg.com](http://www.smeg.com)

Vi anbefaler, at du nøje læser denne vejledning, som indeholder alle anvisninger til at holde det købte apparat i perfekt funktionsmæssig og æstetisk stand.

For yderligere informationer om produktet: [www.smeg.com](http://www.smeg.com)

Zalecamy uważne przeczytanie niniejszej instrukcji, która zawiera wszystkie wskazania dla utrzymania jakości estetyki i funkcjonalności zakupionego urządzenia.

Dalsze informacje dotyczące produktu znajdują się na stronie: [www.smeg.com](http://www.smeg.com)

Lue tämä käyttöopas huolellisesti. Ohjeita noudattamalla taataan laitteen oikeaoppinen ylläpito ja sen ominaisuuksien säilyvyys.

Tuotteeseen liittyvät lisätiedot löytyvät osoitteesta [www.smeg.com](http://www.smeg.com)

Vi anbefaler at du leser denne brukerveiledningen grundig, da den inneholder alle indikasjonjer for å bevare de estetiske og funksjonelle kvalitetene til produktet du har kjønt.

For ytterligere informasjon om produktet: [www.smeg.com](http://www.smeg.com)

نصح بقراءة هذا الكتيب بعناية حيث يضم جميع التعليمات التي تضمن الحفاظ على الخصائص الجمالية والوظيفية للمنتج الذي قمت بشرائه.  
للمزيد من المعلومات عن المُنتج بوجاء زيارة [www.smeg.com](http://www.smeg.com)

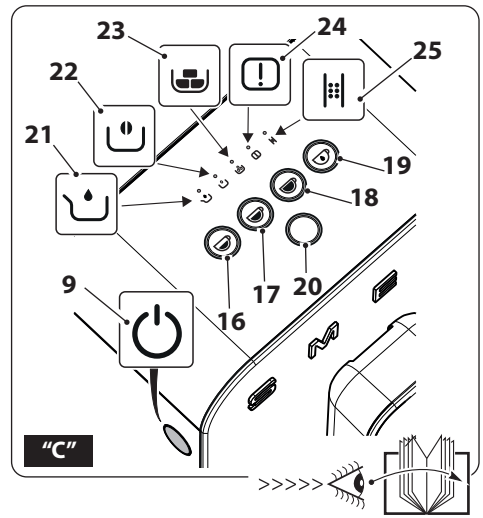
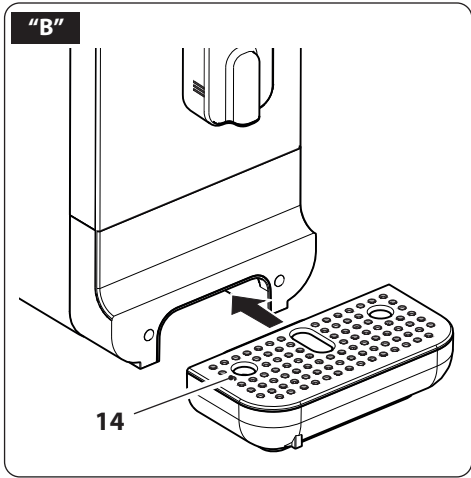
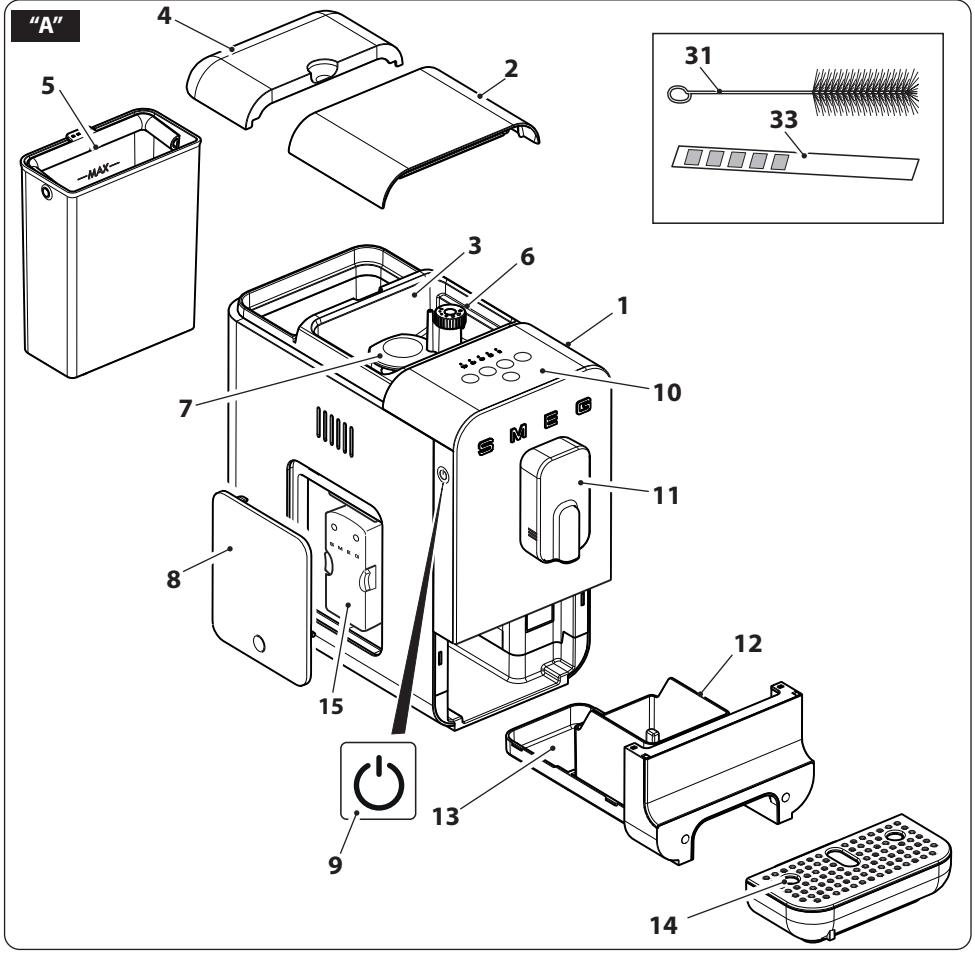

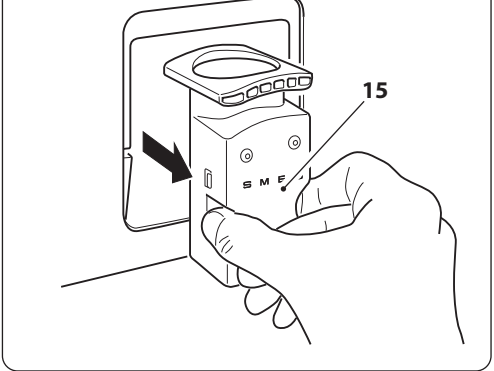
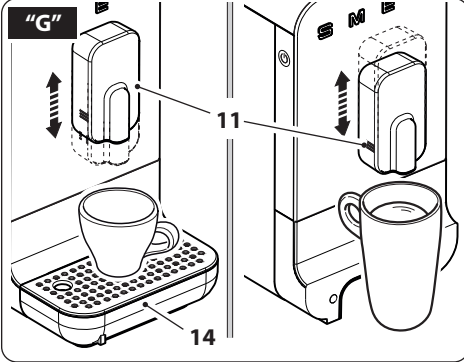
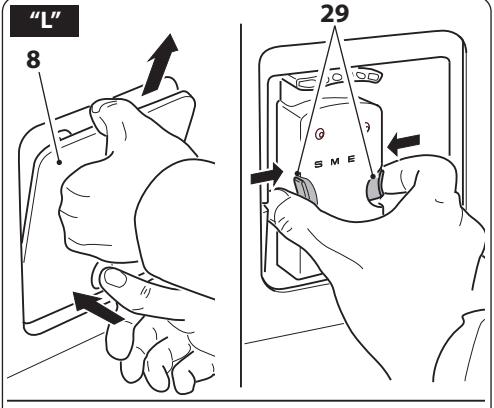
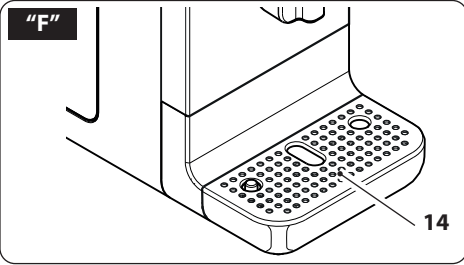
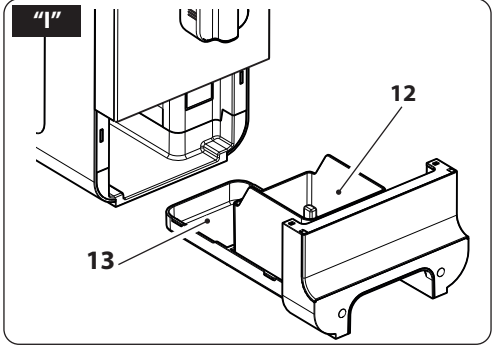
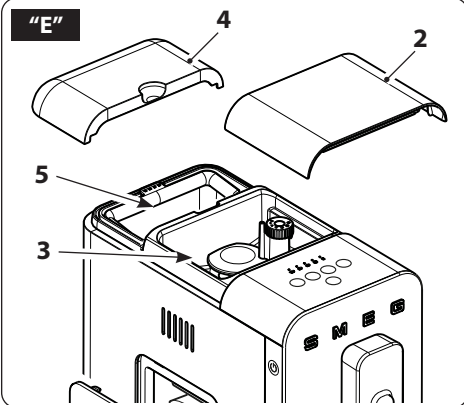
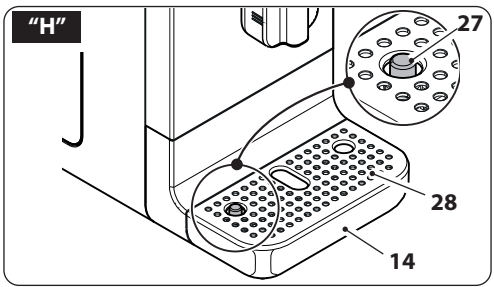
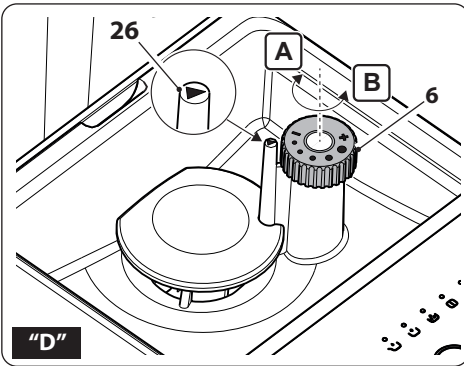

**Informazioni importanti per l'utente / Important information for the user**  
**Informations importantes pour l'utilisateur / Wichtige Informationen für den Benutzer**  
**Belangrijke informatie voor de gebruiker / Información importante para el usuario**  
**Informações importantes para o utilizador / Viktig information for användaren**  
**Важная информация для пользователя / Vigtig information til brugeren**  
**Ważne informacje dla użytkownika / Tärkeitä tietoja käyttäjälle**  
**Viktig informasjon for brukere / معلومات هامة للمستخدم**

**⚠ Avvertenze / Instructions / Avertissements / Hinweise / Waarschuwingen / Advertencias / Advertências / Varningar / Меры предосторожности / Advarsler / Ostrzeżenia / Varoitus / Advarsler / تحذيرات**

Informazioni generali su questo manuale d'uso, di sicurezza e per lo smaltimento finale / General information on this user manual, on safety and final disposal / Informations générales sur ce manuel d'utilisation, sur la sécurité et sur l'élimination définitive de l'appareil / Allgemeine Informationen zu dieser Gebrauchsanleitung, zur Sicherheit und die endgültige Entsorgung / Algemene informatie over deze handleiding, veiligheidsinstructies en uiteindelijke verwerking / Información general del manual relativa al uso, la seguridad y la eliminación final / Informações gerais sobre este manual do utilizador, segurança e para a eliminação final / Allmän information om denna bruksanvisning, om säkerhet och för slutligt bortscaffande / Общая информация о данном руководстве по эксплуатации, безопасности и окончательной утилизации / Generelle oplysninger om denne betjenings- og sikkerhedsvejledning samt endelig bortscaffelse / Ogólne informacje dotyczące użytkowania, bezpieczeństwa i uтиlizacji / Käyttöohjeita, turvallisuutta ja käytöstä poistoa koskevat yleisetiedot / Generell informasjon om denne brukerveiledningen, sikkerhet og endelig kassering av produktet / معلومات عامة عن دليل استخدام هذا الجهاز وسلامة استخدامه وكيفية التخلص عن الجهاز بشكل نهائي

**📖 Descrizione / Description / Description / Beschreibung / Beschrijving / Descripción / Descrição / Beskrivning / Описание / Beskrivelse / Opis / Kuvaus / Beskrivelse / الوصف**

Descrizione dell'apparecchio / Appliance description / Description de l'appareil / Beschreibung des Geräts / Omschrijving van het apparaat / Descripción del aparato / Descrição do aparelho / Beskrivning av apparaten / Описание прибора / Beskrivelse af apparatet / Opis urządzenia / Laitteen kuvaus / Beskrivelse av apparatet / وصف الجهاز

**👉 Uso / Use / Utilisation / Gebrauch / Gebruik / Uso / Utilização / Användning / Использование / Anvendelse / Użytkowanie / Käyttö / Bruk / الاستخدام**

Informazioni sull'uso dell'apparecchio / Information on using your appliance / Informations sur l'utilisation de l'appareil / Informationen zum Gebrauch des Geräts / Informatie over het gebruik van het apparaat / Información sobre el uso del aparato / Informações sobre a utilização do aparelho / Information om användning av apparaten / Информация об использовании прибора / Oplysninger om brug af apparatet / Informacje dotyczące użytkowania urządzenia / Laitteistoa koskevat käyttöohjeet / Informasjon om bruken av apparatet / معلومات عن استخدام الجهاز

**🧼 Pulizia e manutenzione / Cleaning and care / Nettoyage et entretien / Reinigung und Wartung / Reiniging en onderhoud / Limpieza y mantenimiento / Limpeza e manutenção / Rengöring och underhåll / Чистка и техническое обслуживание / Rengøring og vedlikeholdelse / Czyszczenie i konserwacja / Puhdistus ja hoito / Rengjøring og vedlikehold / التنظيف والصيانة**

Informazioni per la corretta pulizia e manutenzione dell'apparecchio / Information for proper cleaning and maintenance of the appliance / Informations pour un nettoyage et un entretien corrects de l'appareil / Informationen zur ordnungsgemäßen Reinigung und Wartung des Geräts / Informatie voor de juiste wijze van reiniging en onderhoud van het apparaat / Información sobre la limpieza y el mantenimiento correctos del aparato / Informações para a limpeza e manutenção corretas do aparelho / Information för korrekt rengöring och underhåll av apparaten / Информация по корректной очистке и техобслуживанию прибора / Oplysninger om korrekt rengøring og vedlikeholdelse af apparatet / Informacje dotyczące prawidłowego czyszczenia i konserwacji urządzenia / Laitteiston oikeaa puhdistusta ja huoltoa koskevat tiedot / Informasjon for korrekt rengjøring og vedlikehold av apparatet / معلومات لتنظيف وصيانة الجهاز بشكل صحيح

**⚠ Avvertenza di sicurezza / Safety instructions / Consignes de sécurité / Sicherheitshinweise / Veiligheidswaarschuwingen / Advertencia de seguridad / Advertências de segurança / Säkerhetsvarning / Предупреждение о безопасности / Sikkerhedsanvisninger / Ostrzeżenie dotyczące bezpieczeństwa / Turvallisuuteen liittyvät varoitukset / Sikkerhetsadvarsler / تحذير للسلامة**

**i Informazione / Information / Information / Information / Informatie / Información / Informação / Information / Информация / Information / Informacja / Tietoa / Informasjon / معلومات**

**📝 Suggerimento / Advice / Conseil / Empfehlungen / Aanbeveling / Sugerencia / Sugestões / Råd / Рекомендация / Forslag / Porada / Neuvo / Forslag / اقتراحات**

Il costruttore si riserva di apportare senza preavviso tutte le modifiche che riterrà utili al miglioramento dei propri prodotti. Le illustrazioni e le descrizioni contenute in questo manuale non sono quindi impegnative ed hanno solo valore indicativo.

The manufacturer reserves the right to make any changes deemed useful for the improvement of its products without prior notice. The illustrations and descriptions contained in this manual are therefore not binding and are merely indicative.

Le fabricant se réserve la faculté d'apporter, sans préavis, toutes les modifications qu'il jugera utiles pour l'amélioration de ses produits. Les illustrations et les descriptions figurant dans ce manuel ne sont pas contraignantes et n'ont qu'une valeur indicative.

Der Hersteller behält sich vor, ohne vorherige Benachrichtigung alle Änderungen vorzunehmen, die er zur Verbesserung seiner Produkte für nützlich erachtet. Die in diesem Handbuch enthaltenen Illustrationen und Beschreibungen sind daher unverbindlich und dienen nur zur Veranschaulichung.

De fabrikant behoudt zich het recht voor zonder waarschuwing alle wijzigingen aan te brengen die hij nodig acht om zijn producten te verbeteren. De afbeeldingen en de beschrijvingen die aanwezig zijn in deze handleiding zijn niet bindend, en hebben enkel een aanduidende waarde.

El fabricante se reserva el derecho a aportar sin aviso previo todas las modificaciones que considere útiles para la mejora de sus propios productos. Las ilustraciones y las descripciones contenidas en este manual no comprometen, por tanto, al fabricante y tienen un valor meramente indicativo.

O fabricante reserva-se o direito de efetuar, sem aviso prévio, qualquer modificação que vise o melhoramento dos respetivos produtos. As ilustrações e descrições contidas neste manual, não são, por isso, vinculativas e possuem apenas valor indicativo.

Tillverkaren förbehåller sig rätten att genomföra alla de ändringar som anses nödvändiga för att förbättra de egna produkterna utan att meddela detta i förväg. De illustrationer och beskrivningar som finns i denna bruksanvisning är vägledande och därmed inte bindande.

Производитель оставляет за собой право вносить без предупреждения все изменения, которые посчитает полезными для улучшения собственной продукции. Рисунки и описания, содержащиеся в данном Руководстве по эксплуатации, не имеют обязательств и имеют ознакомительный характер.

Producenten forbeholder sig retten til at foretage eventuelle ændringer, der anses for at være en forbedring af det oprindelige produkt, uden forudgående varsel. Illustrationer og beskrivelser i denne betjeningsvejledning er derfor ikke bindende og kun vejledende.

Producent zastrzega sobie prawo do nanoszenia, bez uprzedniego powiadomienia, wszelkich zmian, które uzna za przydatne w celu ulepszenia swoich produktów. Rysunki i opisy zawarte w niniejszej instrukcji nie są zobowiązujące i mają charakter poglądowy.

Valmistaja pidättää itsellään oikeuden tehdä ohjeisiin mielestään tarpeellisia muutoksia ilman ennakoilmoitusta. Tässä oppaassa olevat kuvat ja piirroksot eivät näin ollen ole sitovia, vaan ne annetaan vain viitteellisessä mielessä.

Produsenten forbeholder seg rett til endringer på sine produkter grunnet tekniske fremskritt, uten forutgående varsel. Illustrasjonene og beskrivelsene i denne bruksanvisningen er derfor ikke bindende og skal kun betraktes som retningsgivende.

”تحفظ جهة التصنيع لنفسها بالحق في القيام بجميع التعديلات التي تراها مناسبة لتحسين منتجاتها دون إنذار مسبق. ولذلك، لا تعتبر الرسوم التوضيحية والأوصاف الواردة في هذا الدليل ملزمة وإنما ذات قيمة إرشادية فقط“

Dear Customer,

Thank you very much for purchasing the Smeg Line coffee machine.

By choosing our product, You have opted for a solution in which aesthetics and innovative technical design offer unique objects, which become part of the furnishings.

In fact, a Smeg household appliance always co-ordinates perfectly with other products in the range and, at the same time, can become a design object for the kitchen.

We hope You fully appreciate the functionalities of Your appliance.

Best regards.

*SMEG S.p.A.*

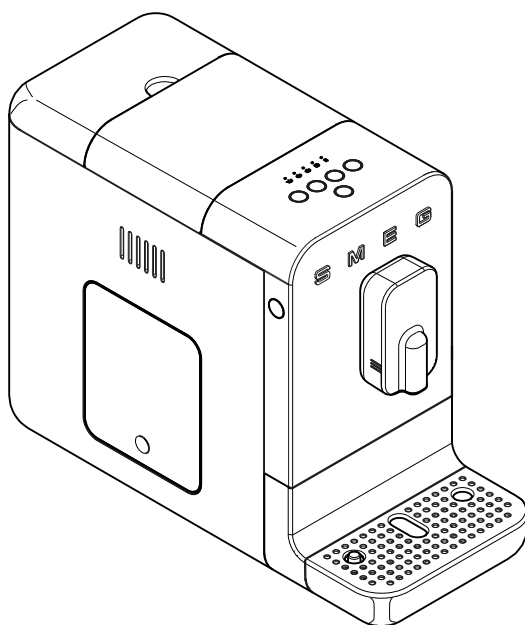

Model BCC01  
Bean to cup Coffee machine



## Important Safeguards

### SAFETY

#### Essential safety recommendations.



Keep these instructions carefully. Whenever the appliance is transferred to other persons, they must also be given these user instructions.

Danger of Electrocutation, since the appliance operates on electric current, it is necessary to comply with the following safety warnings:

- Do not touch the plug with wet hands.
- Make sure that the power outlet used is always freely accessible, because only in this way can it be unplugged when necessary.
- If you want to remove the plug from the socket, grasp the plug directly. Do not remove the plug from the socket by pulling on the cable or with wet hands.
- If the appliance should break down, do not attempt to repair it. Switch the appliance off, remove the plug from the power outlet and contact the Smeg Technical After-sales centre.
- If the plug or power supply cable are damaged, have them replaced exclusively by the Technical After-sales centre, so as to prevent all risks.
- Do not immerse the appliance, the power cord, the plug in water or any other liquid.
- Warning: Danger of injury! Improper use of the appliance can cause injury. Before cleaning, disconnect the plug.
- Do not allow the power supply cable to dangle over the edge of the table or other surface or to come into contact with hot surfaces.

Choking hazard due to plastic packaging, keep the packaging material (plastic bags, expanded polystyrene) out of the reach of children.

- Do not position the appliance on or in proximity of electric or gas cookers, or in a heated oven.
- Do not wash the appliance in the dishwasher.

### Connecting the appliance

**Warning!** Make sure that the mains voltage and the frequency correspond with those indicated on the data plate on the bottom of the appliance.

Only connect the appliance to a current outlet installed perfectly with minimum capacity of 10A and with an efficient earth.

If the plug and power outlet are incompatible, have the power outlet replaced with a suitable type by qualified staff.

In order to avoid a hazard due to inadvertent resetting of the thermal cut-out, this appliance must not be supplied through an external switching device, such as a timer, or connected to a circuit that is regularly switched on and off by the utility.

- Do not use an adapter.
- Do not use an extension cord.
- Do not spill liquid on the power plug and on the power base.

Failure to observe these warnings can result in death, fire or electric shock.

- Keep the appliance out of the reach of children under the age of 8.
- Children must not play with the appliance.
- The use of this appliance is allowed to people (including children of at least 8 years) with reduced physical, sensory or mental abilities only if they are under the control of adults or have been instructed on the safe use of the appliance and have understood the dangers



associated with its use.

- Cleaning or maintenance work can be carried out by children who are at least 8 years old, only under the supervision of an adult.
- Disconnect the appliance from the power outlet before all assembly, disassembly and cleaning operations.

## **Danger of burns**

- Allow the appliance to cool down before cleaning.
- The coffee machine generates heat and produces hot water when running. Avoid contact with boiling water.

## **Use compliant with destination**

- Only use the appliance indoors and at a maximum altitude of 2000 meters.
- Use the device only to prepare coffee-based drinks from grinding coffee beans or to dispense hot water. Other uses are improper.
- Only insert water into the appropriate tank. Use fresh, clean water.
- Use only original spare parts from the manufacturer. The use of spare parts not recommended by the manufacturer could cause fire, electric shock or personal injury.
- The appliance is intended for household and similar use, such as:
  - in the kitchen area for the staff of shops, offices and other work environments;
  - in bed and breakfast and agritourism accommodation;
  - by guests at hotels and motels, and in residential environments.
- Other uses, in restaurants, bars and cafes for example, are improper.

Moreover:

- Do not fill the water container beyond the maximum limit indicated.
- Do not use without water in the tank or without a tank.
- Use only coffee beans to obtain the powder, do not put already ground coffee in the coffee bean hopper.
- Do not insert the appliance in a closed cabinet (built-in type).

Attention: For cleaning surfaces that come into contact with food, observe the special cleaning indications in the instructions.

## **Manufacturer's liability**

The manufacturer declines all liability for damage undergone by persons and objects due to:

- use of the appliance different from that envisioned;
- user manual has not been read;
- tampering of individual parts of the appliance;
- use of non-original spare parts;
- failure to comply with safety recommendations.



## DISPOSAL

Electrical appliances must not be disposed of with household waste. The appliances



that have this symbol are subject to the European Directive 2012/19/EU. All discarded electric and electronic appliances must be disposed of separately from household waste, by taking them to relevant centres envisioned by the Country. By disposing of the discarded appliance correctly, damage to the environment and risks to health will be avoided. For further information regarding disposal of the discarded appliance, contact the Municipal Administration, the Disposal dept. or the shop where the appliance was purchased.

## DESCRIPTION OF THE APPLIANCE (Fig. A)

- 1 Machine body.
- 2 Coffee bean container lid.
- 3 Coffee bean container.
- 4 Water tank cover.
- 5 Water tank (1,4 l).
- 6 Grinding selection knob.
- 7 Grinders protection.
- 8 Brewing group access door.
- 9 ON/OFF button.
- 10 Control panel.
- 11 Height adjustable coffee dispenser.
- 12 Coffee grounds container.
- 13 Internal drip tray.
- 14 External drip tray with level indicator.
- 15 Brewing group.
- 31 Cleaning brush.
- 33 Water hardness test strip.

## IDENTIFICATION PLATE

The identification plate states the technical data, serial number, and marking.

The identification plate must never be removed.

## BEFORE FIRST USE

### (Fig. A)

- Unpack the appliance carefully and remove all packaging materials.
- Rinse the removable components with lukewarm water, such as: water tank (5) covers (2,4), door (8) grounds container (12) drip trays (13, 14) and brewing group (15).



Before use, check that all components are integral and have no cracks.

## ASSEMBLY OF COMPONENTS

### (Fig. B)

- Place the machine on a flat surface and fix the drip tray (14).
- Connect the power supply cable to the socket on the rear of the machine and the other end to a power socket.



## DESCRIPTION OF CONTROLS AND ALARMS (Fig. A-C-D)



### ON/OFF button (9)

Pressing the button switches the machine on or off.



### Change dispensing program button (20)

The product has 8 functions, accessible through two menus, *White Menu* and *Orange Menu*.

By pressing this button it is possible to change the dispensing menu from “*White*” and “*Orange*” and vice versa.

White	Keys LED white
 16	Ristretto coffee
 17	Espresso coffee
 18	Coffee
 19	Hot water
Orange	Keys LED orange
 16	Light Ristretto coffee
 17	Light Espresso coffee
 18	Long coffee
 19	Americano



### Empty water tank alarm (21)

The related LED flashes when the tank (5) is absent, or when the water inside it is missing or at an insufficient level. Insert the tank or fill it with water.



### No coffee alarm (22)

The relative LED lights up steadily indicating that the coffee beans in the container (3) have reached the minimum level or are absent. Fill the container with coffee beans.



### Coffee grounds container alarm (23)

Steady lit LED:

Coffee grounds container full (12); empty the container.

Flashing LED:

Coffee grounds container (12) or internal drip tray (13) missing or incorrectly assembled; the machine is blocked until the components are correctly reassembled.



### Brewing group alarm (24)

Flashing LED:

Door open or brewing group missing or incorrectly assembled; the machine is blocked until the brewing group is correct assembled or door closed.

Stead lit LED:

Indicates that the brewing group, its housing and accessible compartment should be cleaned.



### Descaling alarm (25)

Steady lit LED:

Indicates that it is highly recommended to carry out a descaling cycle;

Flashing LED:

The machine is blocked in all its functions, a descaling cycle is mandatory to restore machine operation.



## Use

### Grinding adjustment knob (6) (Fig. D)

The appliance is equipped with a knob (6) that allows you to adjust the grinding grain of the coffee according to its uses:

Turning the knob (6) clockwise "A" increases the grinding grain; turning the knob (6) anticlockwise "B" decreases the grinding grain and the ground coffee will be finer (Fig.D).

Turn the knob (6) and match the indicator (26) with the desired grinding level.



The grinding grain adjustment must be carried out when the grinder is in operation or on first use when the bean container is completely empty; turning the knob (6) with the grinder stopped and the beans inside could damage the grinding unit.

### USE (Fig. E-F-G-H)

- Lift the tank cover (4) and pour fresh water in the tank (5) being sure not to exceed the indicated 'Max' level. Replace the water tank cover when full (4).
- Lift the coffee bean container lid (2) and introduce the coffee beans into the container (3).
- Check that the drip tray (14) is correctly positioned.
- Press the button (9) , the machine starts the heating phase and the keys light up flashing in sequence.

At the end of the heating, a self-cleaning cycle of the internal circuits is carried out and, once the cycle is finished, the machine is ready to be used.



At the first use it is recommended to make at least one coffee to make a complete break-in of all the circuits.



We recommend setting the water hardness upon first use. Please see the "Water hardness settings" paragraph for this reason.



After 20 minutes of non-use, the machine switches off. If it has made at least one coffee, it performs a self-cleaning cycle. Press the button (9) to switch on the machine.

### Change of dispensing program

The machine has two dispensing menus in its memory: **White** and **Orange**. To switch from one program to another, press the key (20) .

In the **White** menu all the keys are illuminated in white, in the **Orange** menu, all the keys are illuminated in orange.

For the specific functions of each menu, refer to the paragraph "Description of controls and alarms"



Turning off the machine the setting of the **White** or **Orange** dispensing menu remains in the memory at the next restart.

### Dispensing a drink

- It is possible to adjust the position of the dispenser (11) according to the cup used. For very high cups it is possible to remove the drip tray (14).
- Place a cup or large cup under the dispenser.
- Press the key for the desired function. For each selected function, preparation stops automatically. For specific functions, refer to the paragraph "Description of controls and alarms".
- At the end of dispensing, all the keys light up fixed.



Dispensing can be stopped at any time by pressing the dispensing key again.



Remember to reassemble the tray (14) at the end of any dispensing.



It is completely normal that after a prolonged inactivity of the machine (breaks longer than 20 min) the first coffees are not at the right temperature. The tips to obtain a hot coffee immediately are given in the section "What to do if..."

## Customization of the quantity



It is possible to customize, for each type of dispensing, the quantity of coffee or water dispensed.

- Place a cup or large cup under the dispenser.
- Press for at least 3 seconds one of the keys relative to the drink to be dispensed. The selected key lights up flashing; the machine emits a double sound to signal the modification of the preset program.
- On reaching the desired quantity, stop dispensing by pressing the key again; an acoustic signal indicates the memorization of the quantity.



Any customization of the drinks remains saved for future dispensing.



To restore the manufacturer's settings, press the keys (9)  and (20)  simultaneously for at least 3 seconds. The machine emits a single sound to signal the restoration of the factory settings.



## Turning off the machine

- Check that the drip tray (14) is positioned correctly.
- If there is no water, the machine remains in the rinse position until the tank is filled.
- Press the button (9) , the keys (16), (17), (18), (19) light up flashing in sequence and the machine, if it has dispensed at least one coffee, performs a self-cleaning cycle. At the end of the self-cleaning cycle, the machine switches off.

## MACHINE SETTINGS (Fig. C-G)

Through a programming menu it is possible to set the water hardness and the acoustic signals.

### Activation / deactivation of acoustic signals.

The acoustic signals can be disabled / enabled by keeping the keys (17)  and (20)  pressed for three seconds; the key (17)  flashes three times indicating the memorization of the setting.

### Setting the water hardness.

The machine is factory set to "Hard Water Level". The machine can also be set according to the actual water hardness in the various regions for less frequent descaling. If you don't know the water hardness, use the supplied test strip (33) and follow the instructions below.

- Remove the supplied reactive strip from its packaging.
- Fully submerge the strip in a glass of water for about one second.
- Remove the strip from the water and slightly shake it. Read the results after about one



# Cleaning and maintenance



minute.

If 5 blue stripes appear on the strip, select "light water" settings.

If 1 or 2 pink stripes appear on the strip, select "average water" settings.

If 3, 4 or 5 pink stripes appear on the strip, select "hard water" settings.

- To open the water hardness settings, simultaneously press and hold down keys (16) and (20) for at least 3 seconds, LEDs (21) , (22) , (23) will flash simultaneously.
- Choose the water hardness, referring to the following table, pressing the key (16) , the LED relating to the selected hardness lights up steadily, the others go off.

Led	Hardness
21	Light
22	Medium
23	Hard

- To memorize the selected hardness, press keys (16) and (20) simultaneously for at least 3 seconds or do not press any key for 15 seconds.



To prolong the machine operation and preserve the aroma and taste of the coffee, it is recommended to use the Smeg Softener Filter (optional, not supplied). For installation and operation, follow the instructions that accompany the accessory. Once installed, set the water hardness level to 'Light' following the instructions in the previous paragraph.

## CLEANING AND MAINTENANCE (Fig. C-E-G-H-I-L)



Incorrect use Risk of damage to surfaces.

- Do not use steam jets to clean the coffee machine.
- Do not use cleaning products containing chlorine, ammonia or bleach on parts with metal surface finishes (e.g. anodised, nickel- or chrome-plated).
- Do not use abrasive or corrosive detergents (e.g. powder products, stain removers and metallic scourers).
- Do not use rough or abrasive materials or sharp metal scrapers.

### Manual rinse

- Make sure that the **White** program is selected with keys (16), (17), (18), (19) illuminated in white.
- With the machine ready to dispense and the drip tray mounted, press the keys (20) and (19) simultaneously for at least 3 seconds: the machine will rinse the coffee circuit (coffee dispenser 11).
- At the end of the washing cycle, the keys light up steadily.

### Cleaning of the machine body

For a good preservation of the external surfaces it is necessary to clean them regularly at the end of each use, after letting them cool. Clean with a soft cloth dampened with water.



Never immerse the machine body (1) in water or other liquids.



Allow the machine to cool down before cleaning.



Use the supplied brush to clean the empty coffee bean container (3), removing any beans or residue.



Always clean when the machine is off.

## General cleaning

To ensure good machine operations, in addition to excellent quality drinks, we recommend a few simple daily cleaning operations such as cleaning the drip tray (13, 14) and grounds container (12).

We also recommend you routinely clean some specific machine components such as the brewing group (15) or water tank (5). Please see the specific paragraphs for cleaning instructions.

## Cleaning the external drip tray (14)

The drip tray (14) is equipped with a red float (27) which protrudes from the cup-holder grid as soon as the maximum liquid level is exceeded.

- Remove the tray (14) and the cup-holder grid (28) and empty it.
- Clean the tray (14) and the grid (28) in running water with neutral dish detergent.
- Dry the components and reassemble them in the machine.



Do not clean components, especially the cup holder grid, in the dishwasher.



We recommend you clean the external drip tray daily.

## Cleaning the coffee grounds container (12) and internal tray (13)



Always empty the coffee grounds container with the appliance switched on. This is the only way of resetting the coffee grounds counter. The counter resets at least 15 seconds after opening the various components and LED 23 flashes.

- Remove the tray (14).
- Remove the grounds container (12) with its tray (13) by pulling it outwards.
- Empty the coffee grounds from the container (12).
- Clean the container (12) and the tray (13) in running water with neutral dish detergent.
- Thoroughly dry components and reassemble on the machine.



When emptying the grounds container, be sure to also empty any water residue from the internal tank.



Daily cleaning of the coffee grounds container and internal tray is recommended.  
It is normal to find water residue in the internal tank. Clean and dry.

## Cleaning the water tank (5)

- Remove the lid (4) and remove the tank (5) from the machine using the appropriate handle.
- Clean the tank (5) in running water with neutral dish detergent and reassemble it in the machine.



## Cleaning and maintenance

### Cleaning the brewing group (15)



We recommend cleaning the brewing group at least once a week.

- The coffee machine indicates when brewing group cleaning is recommended (steady lit LED 24).
- With the machine on, press the lower part of the door (8) until it is released and slide it out from the top.
- Press the two release clips (29) located on the sides of the infuser (15) and remove it from the machine (Fig.1).
- Wash the brewing group (15) with running water and dry it.
- Also thoroughly clean its housing and relevant compartment and dry them before reassembling the various components.
- Refit the service door (8) making sure it is correctly positioned.



Open the door and clean the brewing unit while the machine is on. This is the only way of resetting the counter.

The counter resets at least 10 seconds after opening the various components and LED 24 turns off.



We recommend running a manual circuit cleaning cycle whenever this operation is performed.

Please see paragraph "Manual rinse" for this reason.



Do not wash the brewing group in the dishwasher in order not to damage it permanently.



Coffee powder residue can be found in the brewing group compartment. We recommend thorough cleaning whenever cleaning the brewing group. Use the supplied brush to remove any residue from the brewing group compartment.



Dry all components and internal parts using a dry cloth before closing the side door.







## Descaling







The coffee machine signals when it is necessary to carry out a descaling cycle based on the set water hardness (For the setting of the water hardness, see the "Setting the water hardness" paragraph).

If the LED (25)  lights up steadily, it means that a descaling cycle is necessary, so as not to alter the taste of the coffee and damage the machine. However, coffee and further drinks may continue to be dispensed for a limited number of cycles.

If the LED (25)  flashes, it means that a descaling cycle is mandatory to proceed with further dispensing of drinks.

To carry out a descaling cycle, proceed as follows:

- Place a container with a capacity of at least 1.4l under the dispenser (11).
- Make sure that the **White** program with white illuminated keys is selected.
- Fill the tank (5), up to the "MAX" level, with a solution of water and descaler in the doses recommended by the manufacturer.
- With the machine ready for use, press the keys (20)  and (18)  simultaneously for at least 3 seconds. The key (18)  flashes with an orange light and the LED (25)  has a fixed light for the entire duration of the descaling cycle.
- Stay near the machine for the entire duration of the descaling cycle since you may be required, for example, to fill the tank (5). The entire cycle lasts approximately 30 minutes.
- During the descaling cycle, the machine will take a few breaks to allow the descaler to act effectively. Wait for the end of the cycle.

- The descaling cycle ends when there is no more solution in the tank (5), the key (18)  turns white and the LEDs (21)  and (25)  remain lit.
- Pour clean water into the tank (5) up to the "MAX" level to carry out the rinse cycle, then press the button (18)  to start the rinse cycle, the button (18)  flashes and the LED (25)  lights up steadily for the entire duration of the washing cycle.
- The rinse cycle ends when the keys light up white.



If, at the end of the descaling process, the LED (25)  remains permanently lit, it indicates that a new descaling cycle must be carried out since the quantity of descaling solution that was used was insufficient for complete cleaning.



Personal injury hazard.

- The descaler contains acids that can irritate the skin and eyes.
- Follow the manufacturer's instructions and safety warnings on the packet scrupulously in the event of contact with skin or eyes.
- Use descaler products recommended by Smeg to prevent damage to the coffee machine.







Any other servicing should be performed by an authorized service representative.



## Cleaning and maintenance

### “Empty system” procedure









The ‘Empty system’ procedure is recommended before long periods of non-use and before consulting a maintenance manager.

- Activate the procedure by holding down the key (16)  and the key (19)  simultaneously for three seconds, the key (17)  and the key (19)  flash simultaneously.
- The entire quantity of water in the tank is drained through the coffee circuit.
- The pump continues to operate, even intermittently, to also empty the internal water circuits.
- At the end of the procedure the machine switches off.





The empty system procedure takes several minutes and on-off cycles. Do not turn off the machine until the complete procedure is complete.

## What To Do If.....

Problem	Possible causes	Solution
The machine doesn't turn on.	Plug not connected.	Connect the plug.
	Plug not fully connected.	Fully connect the plug to the machine.
	ON-OFF (9) button not pressed.	Press the button to start the machine.
The machine is on but does not work.	ON-OFF (9) button not working.	Contact an authorised service centre.
	Empty tank alarm or missing (LED 21  on).	Make sure the tank is correctly assembled or fill with water, or rinse to remove any scale residues.
	No coffee alarm (LED 22  on).	Pour coffee beans in the relevant container.
	Grounds container alarm (LED 23  on).	Empty the grounds container. Note: empty by removing the drawer for at least 15 seconds with the machine on. Alarm 23  flashes to indicate the counter was correctly reset.
	Grounds container alarm (LED 23  flashing).	Grounds container not correctly assembled or internal drip tray missing. Reassemble the components.
	Generic alarm (LED 24  flashing).	Make sure the brewing group is correctly assembled and the door closed.
	Generic alarm (LED 24  on).	Open the access door, remove the brewing unit, check and clean the movement area. If the problem persists, contact an authorised service centre.
Mandatory descaling alarm on (LED 25  flashing).	Run a descaling cycle.	

<b>Problem</b>	<b>Possible causes</b>	<b>Solution</b>
The machine stops when dispensing.	Tank removed during dispensing or water under the minimum threshold.	Make sure the tank is correctly assembled or fill with water.
	The side door was opened during dispensing.	Close the side door again.
Alarm 21  not on but water missing.	Incorrect water reading in the tank due to lime scale inside the tank.	Thoroughly clean and reassemble the tank. Run a descaling cycle if needed.
	Water erroneously poured in the tank gap.	Remove the tank and thoroughly dry its compartment.
Coffee is not hot.	Cups were not pre-heated.	Heat cups by rinsing them with hot water (Note: the hot water function can be used).
	Coffee too roughly ground.	Turn the knob counter-clockwise to tighten the coffee grinders. Warning: to avoid machine damages, we strongly recommend you turn the knob when the machine is in the grinding phase.
Coffee is weak or with little cream.	Dispensing when there are no more beans.	Fill the bean container and dispense coffee again.

Problem	Possible causes	Solution
Coffee dispensed slowly or in drips.	Coffee too finely ground.	Turn the knob clockwise to loosen the coffee grinders. Note: some blends require rougher grinding than others. To avoid machine damages, adjust grinding being sure to rotate the knob when the grinders are running.
	Dispenser clogged.	Manually clean as indicated in paragraph "Cleaning and Maintenance".
A descaling cycle was completed by the machine does not work.	The cycle was not completed.	Make sure the cycle and subsequent rinse are completed. After the first cycle, the machine requires a rinse cycle. Follow the instructions in paragraph "Cleaning and Maintenance".
	The tank was not filled to the maximum level during the descaling cycle or during the following rinse cycle.	Fill the tank being sure to empty the container under the dispenser. Press key 18  again to continue.
The machine does not turn off.	LED 21  is on indicating no water in the tank.	Fill the tank to let the machine run the final rinse cycle.
The machine emitted two beeps and the two button LEDs turned off.	General machine problem.	Contact an authorised service centre.
Drawer blocked.	Incorrect machine use.	Turn the machine off and on to return internal parts to their correct positions.

<b>Problem</b>	<b>Possible causes</b>	<b>Solution</b>
All buttons flash simultaneously.	Hydraulic circuit error.	Make sure there is water in the tank and wait for the circuit to reset. The machine automatically returns to its initial position. If the problem persists, contact an authorised service centre.
 Contact local technical support if the problem is not solved or in case of other types of faults.		