





---

**LAVATRICE  
WASHING MACHINE  
LAVE-LINGE  
WASCHVOLLAUTOMAT  
LAVADORA**

---

	LIBRETTO ISTRUZIONI	IT
	INSTRUCTION MANUAL	EN
	MANUEL D'INSTRUCTIONS	FR
	GEBRAUCHSANLEITUNG	DE
	MANUAL DE INSTRUCCIONES	ES

---

*Contents*

1. PRECAUTIONS FOR SAFETY AND USE .....2  
2. INSTALLATION INSTRUCTIONS.....7  
3. DESCRIPTION OF CONTROLS ..... 12  
4. USING THE APPLIANCE FOR WASHING ..... 13  
5. CLEANING AND MAINTENANCE .....22  
6. TROUBLESHOOTING.....25  
7. ADDITIONAL INFORMATION FOR THE USER.....27

This appliance is tagged  in accordance with European Directive 2002/96/EC on Waste Electrical and Electronic Equipment - WEEE.

This directive contains the regulations governing the collection and recycling of de-commissioned appliances throughout the European Union.

The symbol of the rubbish bin with a line through it on the appliance or its packaging indicates that the product must be disposed of separately from other waste at the end of its life cycle. The user is thus obliged to consign scrapped appliances to the special electronic and electrotechnical waste disposal centres, or return them to the dealer on purchase of a similar new appliance, on a one-to-one basis.

Consignment to the appropriate facility for environmentally responsible recycling, treatment and disposal helps to prevent any negative effects on the environment and health, and encourages the reuse and/or recycling of the appliance's component materials.

Illegal dumping of the appliance by the user will be subject to prosecution under the relevant law.

**READ THE INSTRUCTIONS****ATTENTION!**

*You are advised to read all the instructions in this manual carefully; it will inform you about the right conditions for the proper, safe use of your washing machine.*

*It is very important to keep this instruction manual with the appliance for future reference.*

*In the event of sale or transfer, ensure that the manual always accompanies the appliance, to provide the necessary information about its use.*

## 1. PRECAUTIONS FOR SAFETY AND USE

**ATTENTION!**

**These precautions are detailed for reasons of safety.**

**This section must be read carefully before installation and use.**

***Disposing of packaging***

- Never leave packaging residues unattended in the home. Separate waste packaging materials by type and consign them to the nearest recycling centre.
- Packaging materials (plastic bags, polystyrene, etc.) must not be left within reach of children.

***Disposing of old appliances***

- **Once no longer in use, the appliance must be rendered unusable: permanently disarm the lock on the door (this will prevent children risking their lives by locking themselves inside during play) and cut the power supply lead after removing the plug from the socket.**

**The appliance must be delivered to a recycling facility.**

***Environmental protection***

- Use the whole of the maximum recommended capacity. Never exceed the maximum permitted load.
- Do not use the prewash function for lightly or normally soiled items.
- Follow the manufacturer's recommendations on detergent usage.
- Use the highest spin speed permitted for the fabric type. Fast spins reduce the drying time and thus energy consumption.
- Programs that work with lower temperatures are the most efficient in terms of energy consumption. We therefore recommend that you to make a note of the information on the labels on the items to be washed and provided by the manufacturer. This will mean that the temperatures and detergent doses will be optimized to avoid excessive energy consumption"
- It is recommended to follow the instructions provided in the manual, and those provided by the manufacturers of the detergents, softeners and additives (solvents, degreasers, stain remover additives...) for their correct use and dosage. Failure to comply with the recommendations provided may damage the appliance.

- 
- Information on household detergents, additives and cleaning agents can be found on the following website [www.cleanright.eu](http://www.cleanright.eu).
  - **WARNING:** the higher the spin speed, the higher will be the noise and the lower the remaining moisture content. The lower the amount of residual moisture at the end of the wash, the lower the energy consumption will be during drying."

### **Safety instructions**

- This appliance is intended for domestic use and is compliant with Directives 72/23/EEC and 89/336/EEC (including Directives 92/31/EEC and 93/68/EEC) currently in force.
- Read all the instructions in this manual carefully before installation and use.
- Check that the drum assembly has been released before use (see instructions). Failure to release the drum assembly may cause damage to the washing machine and the surrounding furniture or appliances during the spin cycle.
- This Instruction Manual is an integral part of the appliance: it must always be kept intact with the appliance. Installation must be carried out by qualified staff in compliance with the relevant regulations. The appliance is built to provide the following functions: washing and drying of clothes or fabrics stated to be suitable for machine washing by the producer on the relevant label. All other uses are to be considered improper. **The manufacturer declines all liability for uses other than those stated above.**
- The nameplate with the technical data, serial number and mark is in a visible position in the part in view after the door has been opened. **The nameplate must never be removed.**
- **The electrical and plumbing works required to install the appliance must only be carried out by skilled staff.**
- The appliance must be connected to earth in compliance with electrical system safety regulations. **The manufacturer declines all liability for direct or indirect injury or damage deriving from a non-existent or defective earth connection.**
- In the event that the appliance is not connected by means of a plug, an omnipolar circuit-breaker device with contact gap of at least 3 mm must be provided.
- The plug to be connected to the power supply lead and the relative socket must be of the same type and comply with the relevant regulations. Check that the mains voltage and frequency are the same as the values marked on the nameplate. The use of adapters or junctions is not recommended. Never disconnect the plug by pulling on the power supply lead.
- **The appliance is only disconnected from the electricity supply if the plug has been removed from the socket or the electrical system master switch has been turned off. The power plug must be accessible after the appliance has been installed.**
- The appliance must be installed using new sets of hoses (supplied with the appliance). Old hose sets should not be reused.
- Take care that the appliance is not standing on the power supply cable.

- 
- The washing machine must never be used on vehicles, on board ships or planes, or in environments with hazards, such as explosive or corrosive environments (powders, vapours and gases) or explosive and/or corrosive liquids.
  - Do not install the washing machine in places with a risk of frost. Frozen pipes may burst under the pressure.
  - Make sure that the drain hose connected to the sink **is securely fastened and cannot move.**
  - If it is not fixed in place, the repulsive force of the water might thrust it away from the sink, causing the **risk of flooding.**
  - When connecting the hose to a sink **also check that the water drains from it quickly, as otherwise the sink may overflow.**
  - Do not overload the appliance.
  - Never use detergents which contain solvents or chemicals for washing in the washing machine. **They might damage the appliance and form poisonous vapours. These fumes might also catch fire and explode.**
  - Garments soaked in petroleum products must not be washed in the washing machine. Before washing, check that garments do not contain inflammable devices (e.g. cigarette-lighters, matches, etc.)
  - If volatile cleaning fluids are used, ensure that these substances have been removed from the garments before they are placed in the appliance.
  - Before loading garments for washing, check that the pockets are empty, buttons secure and zips fastened.
  - Do not wash frayed or torn garments.
  - During washing at high temperatures, the glass in the door will become very hot.
  - **Check that all water has been drained from the appliance before opening the door.**
  - If there is water inside, pump it out before opening the door. If in doubt, read the instruction manual.
  - **The water in the appliance is not suitable for drinking!**
  - Swallowing washing machine detergents may injure the mouth and throat.
  - Before removing the garments from the washing machine **check that the drum is at a standstill.**
  - Switch the appliance off after each use to avoid wasting electricity.
  - Leave the door ajar between washes to keep the gasket in good condition.
  - In the event of a malfunction **never attempt to repair the appliance yourself.** Disconnect the appliance from the electricity supply and turn off the water tap. Then contact a qualified engineer. **Repairs must only be carried out by qualified staff.**
  - **The appliance is intended for use by adults.** Do not allow children to tamper with the washing machine's controls or play with it and **do not keep children in the vicinity while the programme is in progress.**
  - Young animals or small children might climb into the washing machine.
  - Always check the inside of the drum before use and **do not allow children to play with the appliance.**

- Keep children away from the appliance when the door or the detergent drawer is open; the appliance might contain detergent residues which may cause permanent injury to the eyes, mouth and throat, or even cause death by suffocation.
- The appliance is not intended for use by persons (including children) with reduced physical, sensory or mental capabilities, or lack of experience and knowledge, unless they have been given supervision or instruction concerning use of the appliance by a person responsible for their safety.
- Do not store flammable fluids near the appliance.

### Length periods out of use.

- If the appliance is not to be used for a lengthy period it should be disconnected from the electricity and water supplies and the door should be left ajar to prevent unpleasant smells from building up inside.

### For Great Britain only

**WARNING:** this appliance must be earthed

#### Fuse replacement

If the mains lead of this appliance is fitted with a **BS 1363A 13amp** fused plug, to change a fuse in this type of plug use an **A.S.T.A.** approved fuse to **BS 1362** type and proceed as follows:

1. Remove the fuse cover (**A**) and fuse (**B**)
2. Fit replacement 13A fuse into fuse cover
3. Refit both into plug

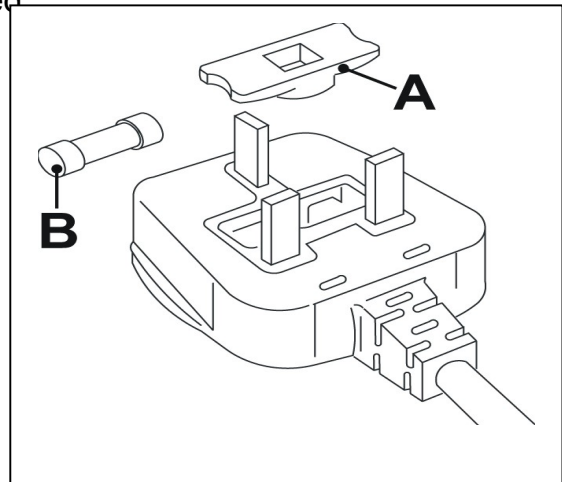

#### Important:

The fuse cover must be refitted when changing a fuse and if the fuse cover is lost the plug must not be used until a correct replacement is fitted.

Correct replacement are identified by the colour insert or the colour embossed in words on the base of the plug. Replacement fuse covers are available from your local electrical store.

If the appliance is provided with a plugless supply cord:

- It is necessary to install in the fixed wiring an all-pole disconnection device having a gap between contacts of at least 3,5mm. After installation the disconnection device has to be easy to reach.
- The connection to the mains must be carried out by a qualified technician in accordance to the scheme shown below and the regulations in force

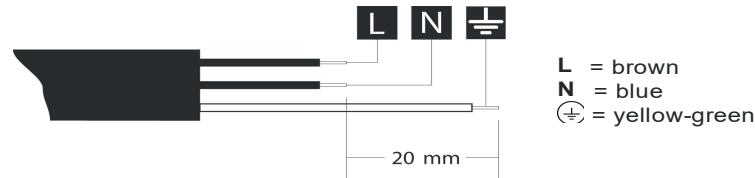

- In the event of damage to the supply cord, it has to be replaced by the manufacturer or an authorized technical service center in order to avoid any risk.

### **Important!**

This appliance is easy to use.

However, for the best results it is important to read this manual carefully and follow all the instructions before putting it into operation.

The manual provides the correct instructions for installation, use and maintenance, as well as giving useful advice.

***The manufacturer declines all responsibility*** for injury or damage caused by failure to comply with the above regulations or deriving from tampering with even just one part of the appliance and the use of non-original spare parts.

## 2. INSTALLATION INSTRUCTIONS

### **Important!**

The appliance must be installed by a qualified engineer in compliance with the relevant regulations.

The washing machine is heavy. Take care when lifting it.

### 2.1 UNPACKING

The unit on flexible mounts is fixed in place for transport using the screws (A) on the rear of the washing machine with the relative plastic spacers (B). Once the screws have been removed, the power supply lead can be used.

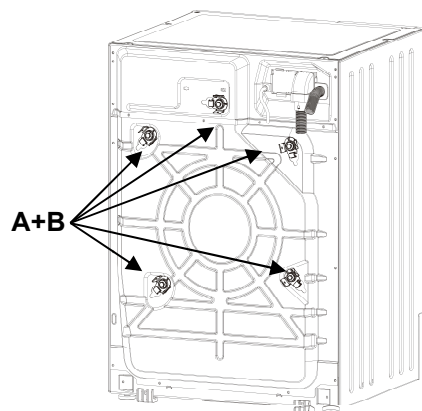

1. Undo **all** the screws with a 10 mm spanner.
2. Remove **all** the screws (A) from the rear
3. Remove **all** the plastic spacers (B)

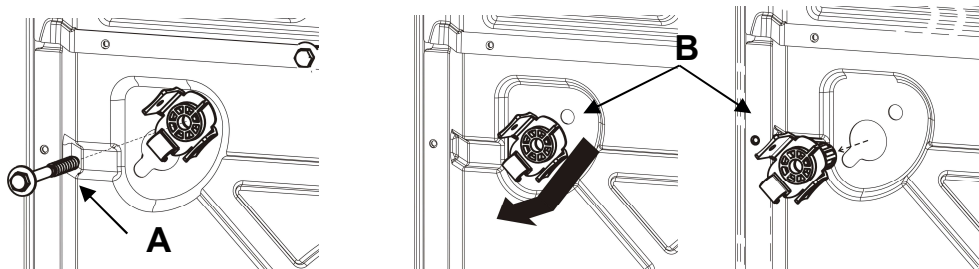

4. Fit **all** the plastic plugs (C) provided, to prevent water splashes from getting into the appliance, and contact with live parts.

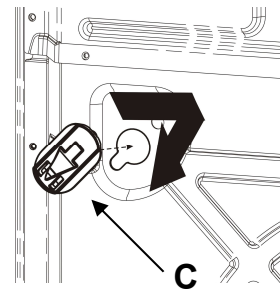

### **Warning!**

- **Do not** turn the appliance upside-down or place it on its sides.
- All the transport retainer fittings should be kept in a safe place; they must be fitted again if the appliance has to be moved around in the future.



## 2.2 POSITIONING AND LEVELLING

1. Place the appliance in the chosen position.
2. Level the appliance carefully in all directions with the aid of a spirit level, adjusting the height of the feet if necessary. Once done, fix the feet in place with the locknuts provided.

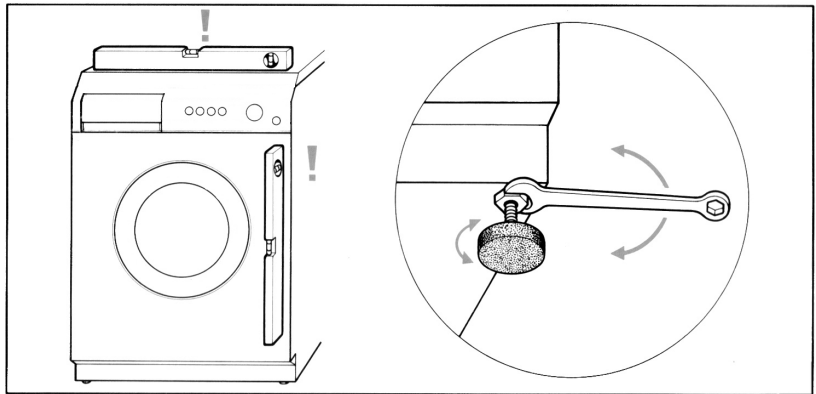

3. On appliances with **adjustable rear feet**, note that the rear of the appliance rests on skids and not on the feet. Before inserting the appliance into its place between the kitchen units, check that the rear feet are screwed fully in to prevent damage as the appliance is shifted into position.

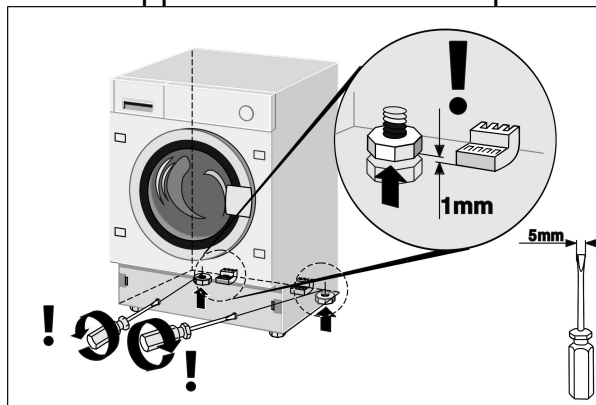

Once the appliance is in position in the kitchen, the height of the rear feet has to be increased so that the appliance no longer stands on the skids. After adjusting the rear feet, level the appliance and fix the front feet at the height required.

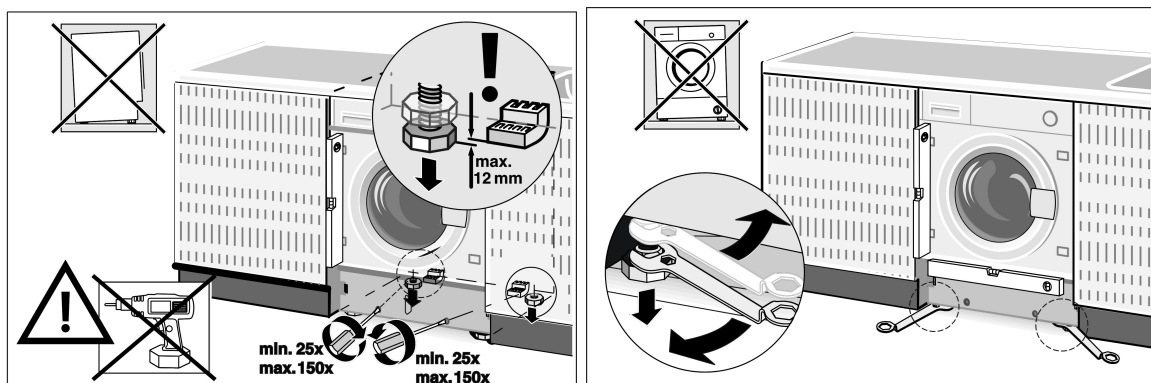

The water intake and drain hoses can be fitted pointing to the left or right for effective installation.

**Warning!**

- This operation must be carried out with care to prevent the washing machine from vibrating, moving or generating excessive noise during use.
- If the appliance is installed on a carpeted floor, take care to ensure that the openings in the bottom of the washing machine are not obstructed.
- Also check that during operation the washing machine is not resting against walls, kitchen units, etc.
- The appliance must not be installed behind a door with lock, a sliding door, or a door with hinge on the opposite side.

**2.3 CONNECTING TO THE WATER SUPPLY**

1. Check that the water supply pressure is in the following range: **0,05-0,9MPa**. With higher pressures, use a pressure reducer.
2. Connect the **cold water** supply hose (**blue** screw collar) to the cold water tap with  $\frac{3}{4}$  gas threaded connector, taking care to tighten firmly to prevent leaks. The water supply hose must not be kinked or crushed and must not be changed or cut. Threaded connections must only be tightened by hand.
3. When appliances are supplied with **hot water**, the intake water temperature must not exceed 60°C and the hose with **red** screw collar must be connected to the hot water supply tap.

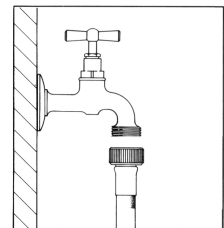
**Warning!**

- If the connection is made to new pipelines, or lines which have been out of use for a long time, allow a considerable amount of water to flow out before connecting the intake hose. This prevents any sand or other dirt from fouling the filters installed in the appliance to protect the water intake valves.
- The new intake hose supplied with the appliance must be used, and the old water supply hose must not be used.

**Supplementary note regarding the water connection for the German market.**

Before connecting the product to the water supply, make sure that the water system has been fitted with a safety device to protect drinking water against contamination due to backflow (according to DIN EN 1717). The water valves and/or taps are fitted with these safety devices if the water system of the house has been properly implemented.

## 2.4 CONNECTING TO THE DRAIN

1. Insert the end of the drain hose into a drain pipe having inside diameter of at least 4 cm, at least 50 to 90 cm above floor level, or connect it securely (using the plastic fitting on the elbow in the hose) to a sink or bathtub.

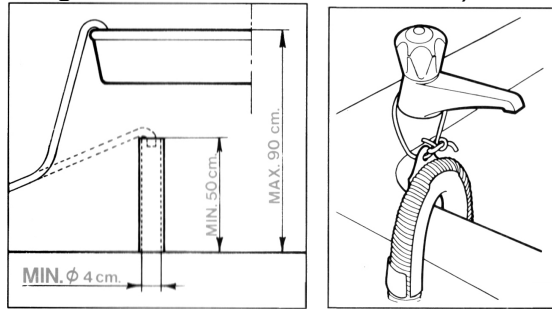

2. In all cases, check that the end of the drain hose is securely fixed to prevent the repulsive force of the water from pushing it out of place.

### Warning!

- Avoid kinks or restrictions to ensure effective drainage.
- Any drain hose extensions must be no more than 1 metre long, must be of the same diameter and must be free from restrictions of all kinds.
- The end of the drain hose must never be submerged in water.

## 2.5 ELECTRICAL CONNECTION

Before connecting the plug to the power socket ensure that:

1. The electrical system voltage is the same as that stated on the nameplate on the front of the appliance, in the zone visible when the door is open. The rated power supply and the fuses required are specified on the nameplate.
2. The meter, safety breakers, power supply line and power socket are rated to withstand the maximum load required, stated on the nameplate.
3. The power supply socket and the plug fitted to the appliance are compatible without the use of reductions, multiple sockets, adapters and extension leads which might cause overheating or scorching.  
If the power supply socket is not compatible with the plug supplied, replace the socket with one of the appropriate type.

### Warning

- The power plug must be accessible after the appliance has been installed.
- **It is absolutely essential to connect the appliance to earth.** Connect the plug to a socket with an earth connection in good working order.

**The manufacturer declines all liability for direct or indirect injury or damage deriving from a non-existent or defective earth connection. Correct electrical connection guarantees conditions of maximum safety.**

- This appliance is compliant with the requirements of EEC directive 89/336 of 3.5.89 (including the amendment directive 92/31/EEC) concerning the elimination of radio-frequency disturbance.
- If the power supply lead is damaged, it must only be replaced with an original spare, available from the After-Sales Service.
- **Do not connection/disconnect the power supply plug from the socket with wet hands**
- **Only disconnect the power supply plug from the socket by taking hold of the plug itself, never by pulling on the lead.**

### 3. DESCRIPTION OF CONTROLS

#### 3.1 CONTROL PANEL

All the appliance's control and monitoring devices are placed together on the front panel.

**Display:** shows the settings (spin speed, cycle status, child lock on/off). The settings can be modified using the buttons underneath.

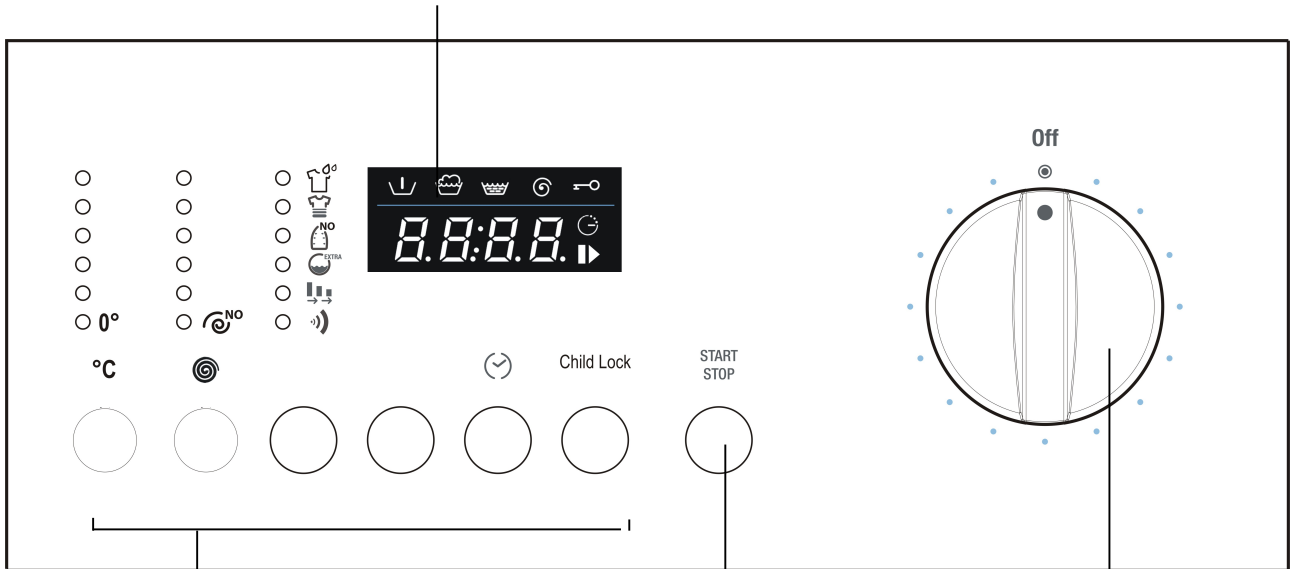

Buttons (from left to right):  
**Temperature selection**  
**Spin speed selection**  
**Option selection**  
**Confirm option**  
**Remaining time**  
**Child Lock**























**Start/Pause button:**  
 For starting and stopping working cycles.

**Programme Selector**  
 For switching the washing machine on and off and selecting programmes. Can be turned in either direction. Does not turn while programmes are in progress.

## 4. USING THE APPLIANCE FOR WASHING

### 4.1 PREPARING THE ITEMS FOR WASHING

- Subdivide the items for washing by fabric type and colour fastness.
- Wash white and coloured items separately. New coloured items should be washed separately the first time. Normally, items carry labels with washing instructions. The following is a short description of the symbols used on these labels.

WASHING		BLEACHING			
	Machine wash at max. 90°C	 Bleaching allowed	 Do not bleach		
	Machine wash at max. 60°C				
IRONING					
	Machine wash at max. 40°C	 Hot iron	 Warm iron	 Cool iron	 Do not iron
	Machine wash at max. 30°C				
DRY CLEANING					
	Machine wash, delicate cycle at max. 60°C	 Any solvent	 Any solvent except trichloroethylene	 Petroleum solvent and R113	 Do not dry clean
	Machine wash, delicate cycle at max. 40°C				
	Machine wash, delicate cycle at max. 30°C				
DRYING					
	Hand wash	 High temperature	 Less than 60°C	 Do not tumble dry	
	Do not wash				

- Do not wash unhemmed or torn items as they may fray.
- Unrelated items in the wash may damage the garments or parts of the washing machine. So: empty pockets and turn them inside-out, and remove wheels from curtains or wrap them in a mesh bag.
- Wash very small items (belts, handkerchiefs, socks, padded bras, etc.) in a white canvas bag. Fasten press-studs and zips and sew on loose buttons.
- The use of modern detergents and the correct washing temperature is generally sufficient to remove stains from fabrics. However, some difficult stains such as grass, fruit, egg, blood, rust, ballpoint pen, etc. should be dealt with before washing. **Depending on the type of fabric, there are a large number of commercial stain removers on the market. In all cases, stains should be cleaned or diluted at once, since the older they are, the harder they are to remove.**
- Failure to comply with washing guidance symbols may result in damage to the items washed.**

**Wool** – Only wool marked as pure new wool, with the  mark, or labelled "shrink-proof, machine-washable" can be washed in a washing machine on the specific programme; other types of wool should be hand-washed or dry-cleaned.

## 4.2 OPENING THE DOOR

The appliance is fitted with a safety device which prevents the door from being opened while the programme is in progress.

1. **Check that all the water has been drained from the tank and the drum is at a standstill.**

### **Warning!**

- If the washing programme is interrupted, it will be from 3 to 15 minutes before the door can be opened, depending on the temperature reached inside the appliance.

### **Warning!**

**The water may still be boiling hot if the wash was at high temperature. Do not open the door if there is still water in the drum!**

## 4.3 LOADS OF WASHING

As far as possible, **to save electricity, it is more economical to wash complete loads of the various types of fabric.** Shake out the washing before loading, and alternate large and small items. It is best to weight the load the first few times, after which you will be able to rely on your experience. As a guide, the following is a list of the average weights of the standard items:

## 4.4 LOADING THE ITEMS FOR WASHING

1. Open the door and load the washing, distributing it evenly over the drum, with items opened out and not bundled together; if possible, large and small items should be well mixed.
2. The washing machine covered by this manual can be **loaded with up to 7kg** of washing for each wash. If this weight is exceeded, the washing results will be poor and the appliance may malfunction.
3. **To save energy it is more economical to wash full loads** of the various types of fabric, following the guidance on quantities provided in the "Programmes Table" supplied in this manual.
4. Close the door by pressing against the frame until you hear it click shut. Take care not to trap items of washing between the door and the rubber gasket.

### **Warning!**

- If the door is not properly closed, a safety device prevents the washing machine from starting.
- **Do not exceed the maximum load: overloading adversely affects washing results.**

## 4.5 ADDING DETERGENT AND ADDITIVE

The internal tray comprises three compartments, marked with the symbols

 prewash detergent

 main wash detergent

 for fabric conditioner, starch, additives, etc. (e.g. treatment products). The additives are added to the washing tank automatically during the final rinse.

The main wash detergent compartment has a tang allowing the use of liquid detergent. To insert it, pull it towards the front and then lower it.

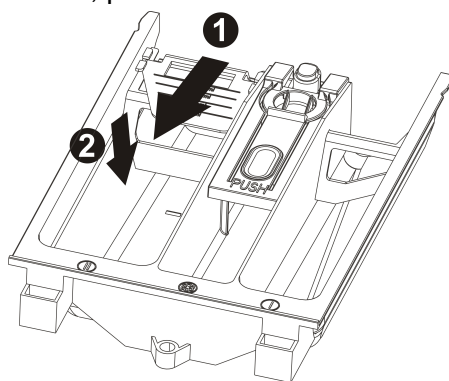

Following the recommendations in the "Programmes Table" supplied with this manual, place the detergent and any additives in the drawer before the start of the programme.

**Never fill with liquids above the maximum level marked;** otherwise the trays will empty too quickly.

Before pouring dense additives into the container, dilute with a little water to ensure they do not clog the outlet.

Use only low-foam detergents suitable for use in a washing machine.

**The amount of detergent must be decided in relation of the hardness of the water, the type and quantity of items loaded, and their degree of dirt.**

This will provide the desired effect with optimal detergent consumption.

On detergent packs the recommended dose is indicated for 4 levels of water hardness and for loads of 4-5 kg of washing with average dirt levels.

Request information about the water's hardness from your water supply company.

### Water hardness

<i>Level of hardness</i>	<i>French degrees fH</i>	<i>German degrees dH</i>
Soft	Up to 15°	Up to 8°
Medium	15° - 25°	8° - 14°
Hard	25° - 40°	14° - 22°
Very hard	More than 40°	More than 22°



#### 4.6 POWDER DETERGENT DOSES

##### Laundry with normal dirt

1. Choose a programme without prewash.
2. Pour the total amount of detergent shown on the pack into the main wash compartment of the detergent drawer.

##### Very dirty laundry

1. Choose a programme with prewash.
2. Place  $\frac{1}{4}$  of the recommended amount of detergent in the prewash compartment of the detergent drawer and  $\frac{3}{4}$  of the detergent in the wash compartment.

##### Warning!

- If no recommended doses are provided, for delicate items in synthetic fibre use from  $\frac{1}{2}$  to  $\frac{2}{3}$  of the recommended dose for washing tough cotton fabrics.
- Only neutral detergents recommended for wool should be used on the wool programme.
- Use the doses recommended by the detergent producer.

#### 4.7 LIQUID DETERGENT DOSES

1. Pour the dose required into the measuring cap supplied with the bottle of liquid detergent and place it in the drum, or use the main wash compartment of the detergent drawer, fitting the insert provided.
2. The scale on the red insert is intended as an aid when deciding the dose of liquid detergent.

##### Warning!

- Liquid detergents can be used, at the doses recommended by the producer, **only for the main wash, i.e. in all programmes without prewash.**

#### 4.8 DESCALERS

Descalers can be added to the prewash and main wash compartments as recommended by their producers.

Place the detergent in the compartments first, followed by the descaler.

#### 4.9 PROGRAMMES AND FUNCTIONS

**For advice on selecting programmes in relation to the type of fabric, refer to the "Programmes Table", supplied with this manual.**

**4.10 SWITCHING ON THE APPLIANCE AND SELECTING THE WASHING PROGRAMME**

To switch on the appliance and select the programme, proceed as follows:

1. Turn the programmes knob in either direction. This switches on the washing machine.
2. Select the washing programme. The time left to the end of the programme on the display. The symbols on the display light up to identify the information shown.
3. The default spin speed values are shown. The initial settings can be modified using the button underneath the sequence of spin speeds. And temperatures
4. If spin speed  is set, there will be no spin cycle and the appliance will stop with the tank full. If this value is set the appliance does not perform the final spin and the washing programme ends with water in the tank.

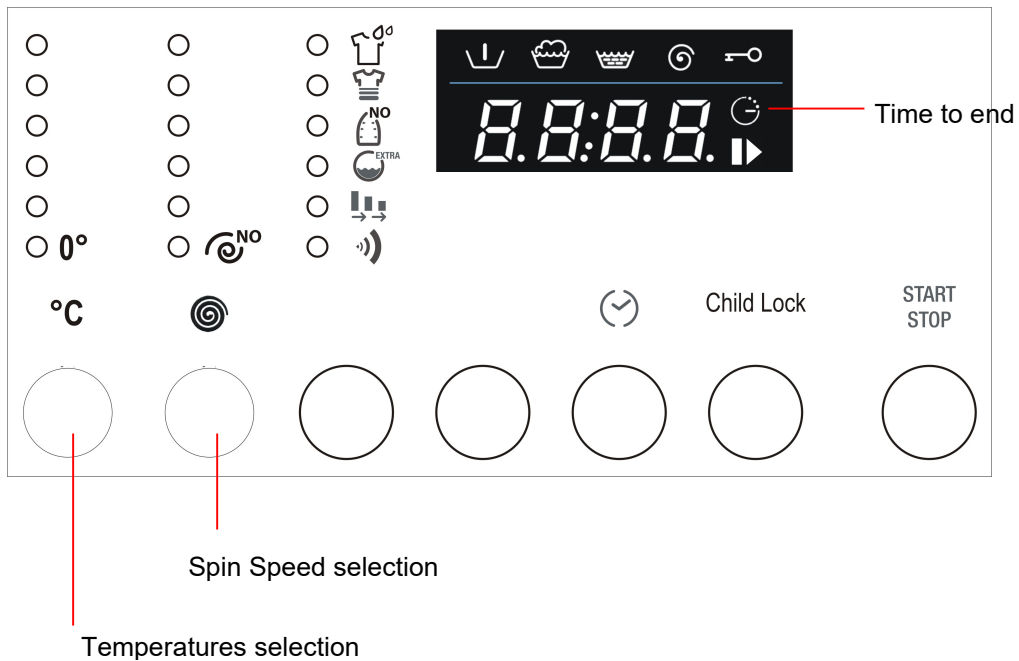

#### 4.11 SELECTING AND CONFIRMING OPTIONS

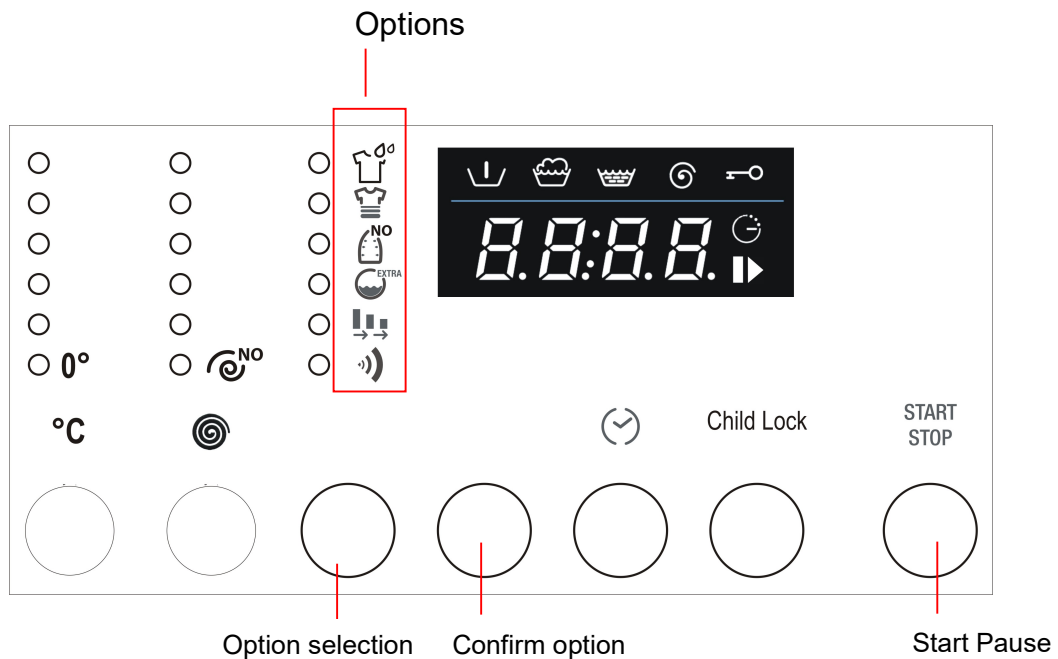

1. The Option Selection button can be used to select the following options in sequence (from the top down):

**Prewash:** adds a stage before the main wash, lasting about 20 minutes at a temperature of 35°C. Suitable for loads of particularly dirty items.

**Intensive:** the max. temperature is changed to 60°C and the washing stage is extended to increase the effectiveness of the enzymes in the detergents. Suitable for delicate but dirty items.

**Easy iron:** produces items which are less creased and easy to iron.

**Water plus:** Increases the amount of water used for washing and rinses.

In alternative **Extra rinse:** this option adds a rinse to the selected washing programme.

**Rapid:** reduces the duration of the washing cycle. Suitable for small amounts of laundry with only light dirt.

**Buzzer:** sets whether or not the buzzer will sound at the end of the cycle. The appliance comes with the buzzer function "on".

2. To confirm the selected option, simply press the Confirm options button and the LED of the option remains on.
3. To delete an option selection, simply return to the option with the Selection button and press the Confirm options button. To annul all the options previously selected in a single operation, simply hold down the Confirm options button for 4 seconds.
4. The Buzzer option retains its "on" or "off" status for subsequent cycles. It is only automatically switched to "off" if the Night Wash programme is chosen.

**4.12 TIME TO END**

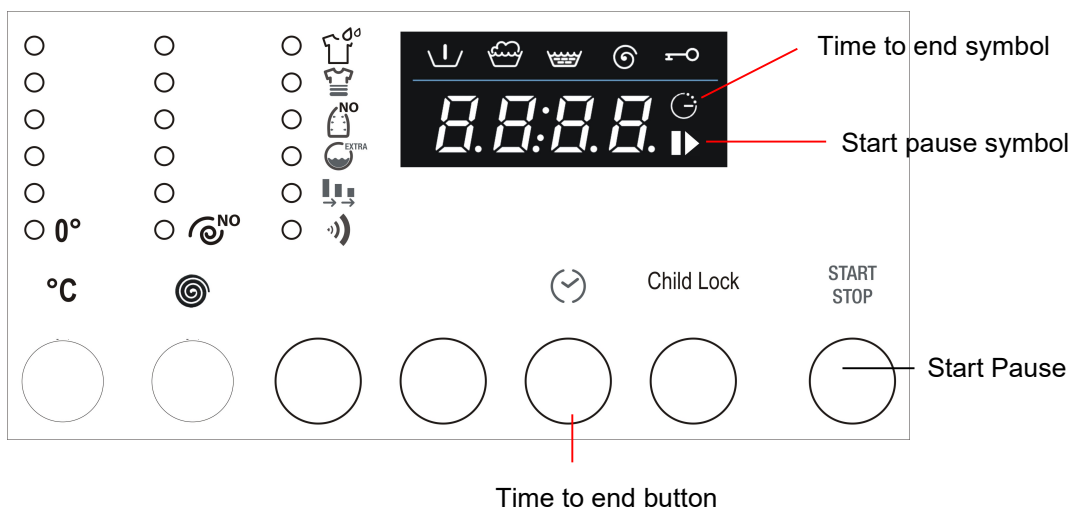

1. The Time to End key can be pressed repeatedly to select the time after which the washing programme will end. The time to end of cycle function calculates the initial duration of the washing cycle, the settings made (temperature, spin speed and options) which may shorten or lengthen the cycle's initial duration, and the delay time the user wishes to add before the cycle starts.
2. After the time to end has been set, the symbol on the display remains on.
3. To annul the Time to End function, keep pressing the key repeatedly until the display shows 0.
4. The Start Pause symbol flashes on and off until the cycle starts. After the cycle starts, the symbol remains constantly lit.

**4.13 STARTING THE WASHING PROGRAMME**

1. To start the washing programme after making your personal settings, press the Start Pause button.
2. Once the cycle has started, the display shows the time remaining before the end of the cycle and the Start Pause symbol on the display is constantly on.
3. During performance of the washing programme, the symbols which identify the various phases light up:

Cycle phase symbols: Prewash, wash, rinse and final spin.

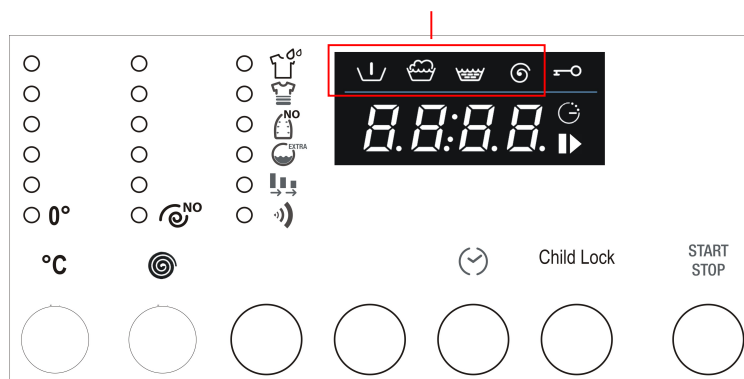

#### 4.14 INTERRUPTING OR CHANGING THE WASHING PROGRAMME

The washing programme in progress can be interrupted at any moment:

1. Press the "Start/Pause" button for about 3 seconds: the display shows the word PAUS (for 1 second) alternating with the time remaining until the end of the cycle (for 1 second). The Start/Pause light flashes on and off.  
Programmes can also be interrupted by turning the programme/temperature setting knob while the cycle is in progress.
2. To change the washing programme, simply turn the programme knob to select the new programme; there is no need to set the appliance in pause status. The new cycle will be carried out completely, beginning from the start. If the tank had already been filled with water during the previous cycle, the water intake phase will be omitted from the new programme.
3. To restart the cycle, press the Start-Pause button again.

#### 4.15 PROGRAMME END

Washing programmes are completed automatically. The word END appears on the display and the "Time remaining" light goes out.

1. **Switch the appliance off by turning the programmes knob to OFF**
2. Unload the laundry from the drum.
3. Leave the door ajar to allow the interior of the washing machine to dry out.
4. **Turn off the water intake tap.**

If during the initial spin speed setting stage, the "no spin" mode with stop with tank full  (spin speed set as 0) was selected, at the end of the washing programme the word STOP appears on the display, alternating with ---- (spin speed of 0) and the spin light is on. To proceed with the pump-out and spin, press the spin selection button twice. The appliance restarts the cycle with the pump-out and spin. To select the spin speed required, press the button until the chosen speed is displayed. To pump out the water from the tank without performing the spin, press the spin selection button until the display indicates speed of 0: the pump-out will be run without spin.

#### 4.16 CHILD LOCK

1. When this function is activated, the modification of options, temperatures, spin speed and the washing/drying cycle is not possible while the cycle is in progress.

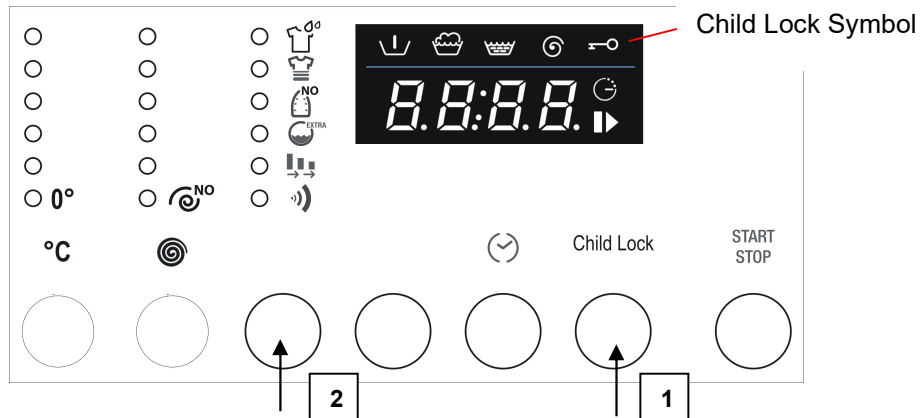

2. To activate the Child Lock Function, press the Child Lock (1) button and hold it down. Also press the Option selection (2) button within 3 seconds.
3. The Child Safety Function symbol lights up to show that the function has been activated.
4. Repeat the same procedure to deactivate the function.

#### 4.17 OPENING THE APPLIANCE IN AN EMERGENCY

In the event of a power failure, the door is opened using the mechanical release device activated by means of the lever in the bottom of the appliance:

- Turn the knob to Off and disconnect the power supply plug from the socket.
- Drain off the water (see point 5.4)
- Pull the lever down and open the door.

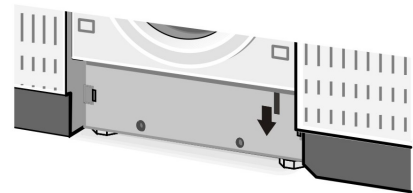

**Warning, scolding hazard:** before opening the door, check that the appliance does not contain boiling hot water and detergent which may pour out and cause injury when the door is opened.

**Warning:** do not open the door using the emergency release lever while the drum is turning.

## 5. CLEANING AND MAINTENANCE

**Important – Before carrying out any cleaning or maintenance procedure, the plug must be disconnected from the power supply socket.**

### 5.1 CLEANING THE OUTSIDE OF THE APPLIANCE

- Regular, thorough cleaning will keep your appliance looking good.
- Clean the exterior of the appliance with soap and water only, then dry thoroughly with a soft cloth.
- The plastic parts should just be wiped with a damp cloth.
- Do not scrape with pointed objects, or use solvents or products containing abrasive substances because they damage the surfaces.
- **For reasons of safety, never spray the washing machine with jets of water.**

### 5.2 CLEANING THE DRUM

- Remove any rust marks from the drum using a stainless steel cleaner, or very fine sandpaper for particularly stubborn cases.
- For descaling the washing machine use only brand-name descalers which contain an anti-corrosion agent for washing machines.
- Always follow the producer's instructions with regard to use and dosages.
- **After descaling or removing rust from the drum, carry out a few rinse cycles to remove all acid residues which might damage the appliance. Never use cleaners which contain solvents. There is the risk of the formation of vapours which might catch fire and explode.**

### 5.3 CLEANING THE DOOR GASKET

Check regularly that there are no paper clips, buttons, nails or pins in the folds of the door gasket.

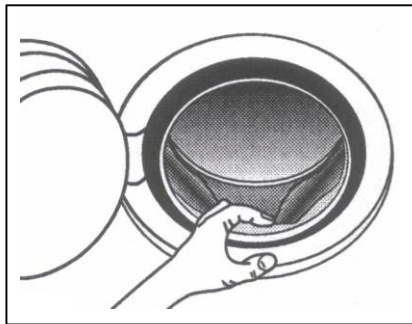

## 5.4 CLEANING THE DRAIN PUMP

The drain pump only needs cleaning if it has been blocked by buttons, brooches or similar objects and the water is not being pumped out. In this case, proceed as described below.

1. Remove the mains plug to disconnect the appliance from the electricity supply.

2. Depending on the model, proceed as follows:

Built-in/totally concealed model – use a small screwdriver as a lever to remove the plugs shown here, turn the plinth downwards and access the pump.

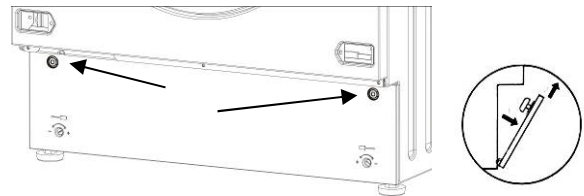

Free-Standing Model – Insert a small screwdriver through the slits in the front of the plinth, then apply upward leverage with the screwdriver to release the top of the plinth from the cabinet.

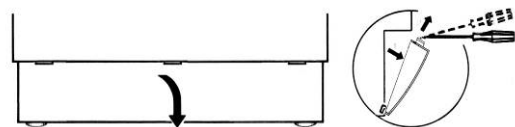

Tilt the plinth forward slightly and pull it upward to remove it completely.

3. Extract the drain hose "A".

**WARNING:** if the hose is hot, the water is hot or boiling hot. Place a shallow container on the floor and remove the plug "B" to drain off the water.

Depending on the amount of water in the appliance, the container may have to be emptied several times. When no more water is coming out, close the hose again by pushing the plug "B" firmly back into place.

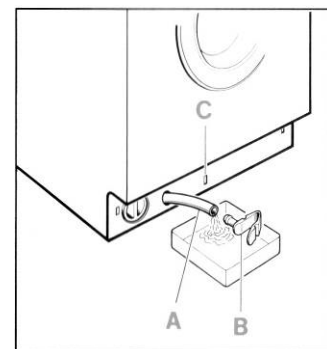

4. Unscrew the cover of the pump "D" by turning it to the left. Clean the pump and remove any foreign bodies. Also check the inside "E", making sure that the impeller turns freely; any foreign bodies stuck in it must be removed.

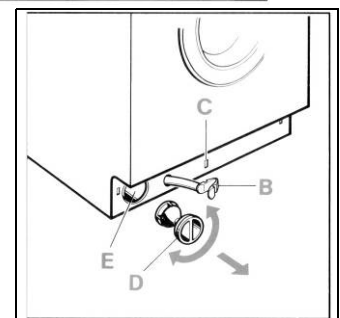

5. Screw the cover back on the pump.

Secure the drain house by snapping the plug back into place "C".

Depending on the model, replace the plinth as follows:

Built-in/completely concealed model - Fit the bottom of the plinth first. Push it towards the cabinet and put the plugs back into place.

Free-standing model – Fit the bottom of the plinth first and then push it towards the cabinet until it snaps into place.



## 5.5 CLEANING THE DETERGENT DRAWER

The detergent drawer should be kept clean, removing all solid deposits.

To simplify this operation, completely remove the detergent drawer (pull the drawer fully out, press in the zone marked PUSH and then remove completely).

Remove the siphon "A" and clean all parts with hot water.

Fully re-insert the siphon and remove any detergent deposits before putting the drawer back in position.

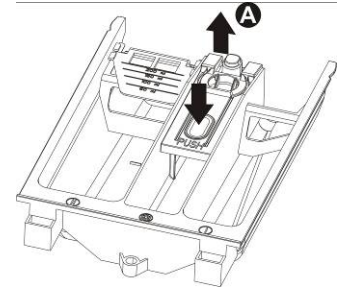

## 5.6 CLEANING THE WATER INTAKE FILTERS

The machine is fitted with a filter which protects the water intake valves.

The filter is in the fitting on the intake hose which is connected to the tap. The filter must be cleaned if the washing machine is not taking in water or the amount of water is insufficient.

To clean, proceed as follows:

- **Remove the mains plug to disconnect the appliance from the electricity supply.**
- Turn off the water tap.
- Unscrew the intake hose fitting from the tap.
- Unscrew the intake hose fitting from the tap.
- Clean the filter with water, with the aid of a small brush.
- When screwing the intake hose fitting back into place, check that the filter is positioned correctly.

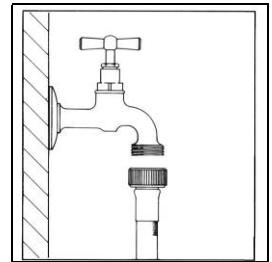

## 5.7 PERIODIC CLEANING

Carry out periodic cleaning to keep the appliance in good working order (see **CLEANING AND MAINTENANCE** section) **to prevent the build-up of limescale, unpleasant odours and mould**. A descaler can be used, following the instructions supplied with the descaler. Clean the dispenser drawer at least once or twice a month to avoid the build-up of detergent. Periodically check the water supply filters. See the procedure outlined in the manual.

## 6. TROUBLESHOOTING

This produce complies with the relevant regulations governing the safety of electrical equipment. For safety reasons, any technical inspections or repairs must be performed by qualified staff, to prevent all hazards for the user.





If the appliance does not work, before calling the After-Sales Service, to avoid unnecessary expense, check yourself that the operations listed in this [troubleshooting table](#) have been carried out..

- |   |   |
|---|---|
| <b>1 Appliance does not start</b>   | <p>Check that:</p> <ul style="list-style-type: none"> <li>- plug is properly connected to socket</li> <li>- door is securely closed</li> <li>- "Start/Pause" button has been pressed.</li> </ul>  |
| <b>2 No water filling</b>   | <p>Check that:</p> <ul style="list-style-type: none"> <li>- plug is properly connected to socket</li> <li>- door is securely closed</li> <li>- water tap is turned on</li> <li>- water intake hose filters not fouled.</li> <li>- water intake hose not trapped or kinked.</li> </ul> |
| <b>3 No water visible in washing drum</b>   | <p>No malfunction.</p> <p>The water level is below the level of the glass in the door because new appliances use very little water to achieve the same washing and rinsing results.</p>   |
| <b>4 Water not pumped out</b>   | <p>Check that:</p> <ul style="list-style-type: none"> <li>- drain hose is not kinked</li> <li>- drain pump not fouled.</li> </ul>   |
| <b>5 Water not pumped out after last rinse in delicate fabrics and wool wash programmes</b> | <p>It is not a malfunction: pause programmed into washing programme to prevent creasing of fabrics.</p> <p>To pump out water, proceed as described in "Programme End" point.</p>  |
| <b>6 Water takes in and pumps out water continually</b>                                     | <p>Check that end of drain hose is not too low down.</p>  |
| <b>7 Strong vibrations during spins</b>   | <p>Check that:</p> <ul style="list-style-type: none"> <li>- Appliance is properly levelled</li> <li>- washing machine not too close to walls or kitchen units</li> <li>- internal unit on flexible mounts locked in position.</li> </ul>  |
| <b>8 Too much foam formed in tank and flowing out of drawer</b>                             | <p>Check that:</p> <ul style="list-style-type: none"> <li>- detergent used is recommended for automatic washing machines and not for hand washing</li> <li>- quantity used is as stated in manual and no more</li> </ul>  |
| <b>9 Water on floor</b>   | <p>Check that:</p> <ul style="list-style-type: none"> <li>- water intake hose fittings not loose</li> <li>- end of drain hose still correctly positioned.</li> </ul>  |
| <b>10 Not all fabric conditioner used or too much water left in compartment</b>             | <p>Check that detergent drawer siphons are correctly fitted and not fouled.</p>   |

- |  |   |
|--|---|
| <b>11 Appliance does not spin</b>        | Anti-imbalance safety device tripped because laundry not evenly distributed in drum. If laundry is still wet at end of cycle, rearrange it in the drum by hand and repeat spin programme only.  |
| <b>12 Emptying water from drum</b>       | In the event of a power blackout or appliance failure, the water can be removed from the drum using the emergency procedure.  |
| <b>13 Laundry not properly spun</b>      | Large items screwed up and not evenly distributed within drum. Always wash a mix of large and small items.  |
| <b>14 Traces of detergent on laundry</b> | Many phosphate-free detergents contain substances with low water solubility.<br><br>Select Rinse programme or brush the laundry.  |
| <b>15 Washing results unsatisfactory</b> | <ul style="list-style-type: none"> <li>- Probably too little detergent or unsuitable detergent used</li> <li>- Difficult stains not dealt with before washing</li> <li>- Correct temperature not set</li> <li>- Basket overloaded.</li> </ul> |

## ERROR DISPLAY

In case of a malfunction, the appliance will identify the problem by showing an error code on the display.

<i>Error code</i>	<i>Key to problem</i>
	Door not properly closed. Try reclosing.
	Aqua stop device tripped. Cut off power supply, turn off water tap and contact nearest service centre.
	Water not taken in for washing. See point 2 in troubleshooting table.
	Water not pumped out. See point 4 in troubleshooting table.

For all the other error codes displayed, cut off the electricity supply, turn off the water tap and contact your nearest Service Centre.

## 7. ADDITIONAL INFORMATION FOR THE USER

The following information is provided in accordance with the European Ecodesign regulation (EU) 2019/2023  
The values indicated for programs other than Eco 40-60 are indicative only.

### Washing machine

Cycle	Rated capacity (kg)	Energy consumption (kWh/cycle) *	Water consumption (l/cycle) (*)	Programme duration (h:min)*	Temperature Max. (°C) 5 min (*) (***)	Spin speed (rpm) *	Residual moisture content (%) *	Detergent
Eco 40-60**	7	1.02	49	2:50	46	1400 (1200) (1000)	48 (55) (61)	Washing powder or liquid detergent for colours, without bleach or optical brighteners
Eco 40-60**	3.5	0.70	43	02:40	36	1400 (1200) (1000)	49 (56) (62)	
Eco 40-60**	2	0.50	39	02:30	32	1400 (1200) (1000)	54 (60) (65)	
Cotton 20°C	7	0.24	62	01:51	20	1400 (1200) (1000)	53 (57) (63)	For white and light-coloured laundry, use a Standard detergent with whiteners. (from cold wash up to 90°C).  Refer to the programs table
Cotton 40°C	7	0.38	62	01:51	40	1400 (1200) (1000)	53 (57) (63)	
Cotton 40°C + Pre-wash cycle	7	1.02	78	02:18	40	1400 (1200) (1000)	53 (57) (63)	
Cotton 60°C	7	1.11	62	01:51	55	1400 (1200) (1000)	53 (57) (63)	
Easy care 40°C	3.5	0.62	50	01:43	40	1000	30	
Mixed load 40°C	3	0.40	36	00:50	40	1200	57	
Wool 30°C	2	0.20	49	00:47	30	600	55	Detergent for woollens

\* The actual values may differ from those indicated due to the pressure, hardness and temperature of the inlet water, the ambient temperature, the type, amount and soiling of laundry, the type of detergent, fluctuations in the mains power supply and any additional functions that have been activated.

\*\* Test programme compliant with European Ecodesign regulation (EU 2019/2023) and the European regulation on energy labelling using cold water (15°C) (EU 2019/2014)

\*\*\* Maximum temperature reached for a minimum of 5 minutes inside the laundry being treated.

IMPORTANT NOTICE FOR TESTING INSTITUTES.

Models intended to be built into a cabinet must be tested in an approved test cabinet with the front panel mounted in accordance with the manufacturer's installation instructions.

---

**\*\* Eco 40-60 program**

Test program compliant with European Ecodesign regulation (EU 2019/2023) and the European regulation on energy labelling using cold water (15°C) (EU 2019/2014).

Washing program that is able to clean normally soiled cotton laundry declared to be washable at 40°C or 60°C together in the same washing cycle.

The **wash and dry** cycle is able to clean normally soiled cotton laundry, washable at 40°C or 60°C together in the same washing cycle and to dry it in such a way that it can be immediately stored in a wardrobe.

**Customer care services**

Original spare parts will be available for a minimum of 10 years from the appliance being placed on the market.

Contact the customer care service in your country or refer to the website and register the product with the required codes. Faults can also be resolved independently before requesting assistance, by referring to the relative section in the manual.

Information on the performance of your washing machine or washer-dryer can be found in the EU EPREL database. The website can be accessed quickly using the QR code on the washing machine or washer-dryer energy label or via the following link <https://eprel.ec.europa.eu>. In this case, you have to enter the name of the model indicated on the data plate on the side of the door. For detailed information on the energy label see: [www.theenergylabel.eu](http://www.theenergylabel.eu).

If the malfunction persists, contact your authorised Service Centre giving the fault code. The contact details of the technical assistance department can be found on the guarantee certificate and the website.

---

<b>ISTRUZIONI DI MONTAGGIO DELLE LAVATRICI INTEGRABILI</b>	<b>IT</b>
<b>ASSEMBLY INSTRUCTIONS FOR BUILT-IN WASHING MACHINES</b>	<b>EN</b>
<b>MONTAGEANLEITUNG FÜR EINBAUBAREWASCH- MASCHINEN</b>	<b>DE</b>
<b>INSTRUCTIONS DE MONTAGE DES LAVE-LINGE INTÉGRABLES</b>	<b>FR</b>
<b>INSTRUCCIONES DE INSTALACIÓN DE LAS LAVA- DORAS INTEGRABLES</b>	<b>ES</b>
<b>INSTRUÇÕES DE MONTAGEM DAS MÁQUINAS DE LAVAR ROUPA INTEGRÁVEIS</b>	<b>PT</b>
<b>MONTAGEINSTRUCTIES VAN INTEGREERBARE WASMACHINES</b>	<b>NL</b>
<b>MONTERINGSANVISNING FOR INTEGRERBARE VASKEMASKINER</b>	<b>DK</b>
<b>MONTERINGSANVISNINGAR FÖR INBYGGNADSBA- RA TVÄTTMASKINER</b>	<b>SE</b>
<b>ANKASTRE ÇAMAŞIR MAKİNELERİ İÇİN MONTAJ TALİMATLARI</b>	<b>TR</b>
<b>ИНСТРУКЦИИ ПО МОНТАЖУ ВСТРОЕННЫХ СТИРАЛЬНЫХ МАШИН</b>	<b>RU</b>
<b>INSTRUKCJA MONTAŻU PRALEK DO ZABUDOWY</b>	<b>PL</b>
<b>تعليمات تركيب الغسالات المدمجة</b>	<b>AR</b>

---

---

<b>IT</b>	Pagina	1
<b>EN</b>	Page	4
<b>DE</b>	Seite	7
<b>FR</b>	Page	10
<b>ES</b>	Página	13
<b>PT</b>	Página	16
<b>NL</b>	Bladzijde	19
<b>DK</b>	Side	22
<b>SE</b>	Sida	25
<b>TR</b>	Sayfa	28
<b>RU</b>	Страница	31
<b>PL</b>	Strona	34
<b>AR</b>	صفحة	37

---

---

## ISTRUZIONI DI MONTAGGIO DELLE LAVATRICI INTEGRABILI

**IMPORTANTE** - La macchina risponde alle vigenti norme di sicurezza relative alle apparecchiature elettriche e deve essere installata da un tecnico specializzato secondo le norme in vigore, onde evitare pericoli per l'utente.

**Dimensioni per l'inserimento** Le quote del vano di alloggiamento devono essere: altezza minima **820mm**, larghezza minima **600mm** e profondità minima **584mm** (fig. 1).

**Notizie tecniche per l'applicazione del pannello** Il pannello può essere fissato sul lato sinistro oppure sul lato destro della lavabiancheria (fig. 2)

La macchina viene fornita predisposta per assemblare il pannello sul lato sinistro; infatti sulla destra si trovano il sistema di chiusura push-pull (nella parte superiore) ed il gommino (nella parte inferiore).

Se si desidera utilizzare la chiusura magnetica al posto della chiusura push pull, occorre togliere il supporto esistente e montare quello in dotazione che porta la chiusura magnetica.

**Importante! Durante le operazioni per l'applicazione del pannello (smontaggio della facciata di tutti i particolari di incernieramento e di chiusura) la lavatrice, deve essere assolutamente disinserita dalla rete di alimentazione elettrica.**

**Avvertenza** - Per fissare il pannello sul lato destro (senso di apertura contrario a quello dell'oblò) occorre smontare dalla parte anteriore della macchina la chiusura push pull (oppure il magnete) ed il gommino (fig. 3-A) e applicarli sul lato opposto (fig. 3-B).

Tutti i particolari applicati alla facciata della lavatrice devono essere rimontati correttamente (nessun foro deve risultare aperto) per evitare assolutamente di toccare parti sotto tensione all'interno della macchina.

**La nostra società declina ogni responsabilità per inosservanza delle predette norme di sicurezza.**

**Uso della macchina**

1) Stabilire l'altezza dello zoccolo della cucina: l'altezza del pannello in legno si ottiene stabilendo prima l'altezza dello zoccolo della cucina.

Esempio: per uno zoccolo di **100mm** corrisponde un'altezza massima del pannello di **720mm**. Se l'altezza dello zoccolo deve essere aumentata, si dovrà ridurre l'altezza del pannello in legno



- 
- 2) Posizionare la maschera nel lato interno del pannello e far coincidere l'altezza dello zoccolo stabilita, con il lato inferiore del pannello stesso (**fig. 4**) attraverso la scala graduata. La maschera deve essere centrata anche in senso orizzontale, facendo riferimento alle linee verticali segnate nelle estremità.
  - 3) Dopo aver posizionato la maschera nella corretta posizione, tracciare le posizioni dei seguenti fori, entrando con la punta della matita:
    - fori per le cerniere e per le viti di fissaggio delle cerniere (**fig. 4**)
    - foro di fissaggio della piastrina metallica (quando si desidera utilizzare la chiusura magnetica), oppure del gancio per la chiusura push pull (**fig. 4, A - B**)

#### **Applicazione dei particolari sul pannello e fissaggio del pannello**

- 1) Praticare sul pannello i fori per l'applicazione delle cerniere (**fig. 5**), del gancio di chiusura per la chiusura push pull (**fig. 5**), oppure della piastrina metallica se si desidera utilizzare la chiusura magnetica (**fig. 6**) e dei fori di fissaggio delle cerniere (**fig. 6**).
- 2) La profondità di 13mm dei fori diametro 2mm, per il fissaggio delle cerniere e della piastrina metallica per il magnete, è valida per il pannello in **legno massiccio**. Per il **pannello in truciolare** forare solamente il rivestimento superiore – **fig. 6**.
- 3) Avvitare al pannello le due cerniere (**fig. 7**)
- 4) Montare, nel lato opposto alle cerniere, il gancio di chiusura per la chiusura push pull, oppure la piastrina metallica per il magnete (**fig. 7**)
- 5) Fissare il pannello alla lavabiancheria seguendo le istruzioni della **fig. 8**.

#### **Regolazione delle cerniere**

Se il pannello, dopo averlo applicato alla lavatrice, si presenta leggermente inclinato o decentrato, rispetto la parte anteriore della macchina, è possibile correggere la sua posizione agendo sulla parte mobile delle cerniere (**fig. 9**).

#### **Posizionamento nella sede d'incasso**

Inserire la lavatrice nel vano d'incasso, girare i piedini se necessario, per livellarla su piano orizzontale e bloccarli con l'apposito controdado. In presenza dei piedini regolabili posteriori, consultare il libretto uso e manutenzione.

Per impedire che vibrazioni dell'apparecchio vengano trasmesse ai mobili in cui risulta inserito, si deve evitare che le fiancate e il piano superiore vengano a contatto con i mobili stessi, **assicurandosi che rimanga una luce di almeno 2mm**. Anche il retro della macchina deve rimanere distante dalla parete posteriore.

**Se il vano d'incasso ha l'altezza di 870 mm deve essere**

---

**utilizzato il kit di innalzamento della lavabiancheria acquistabile tramite il Servizio Ricambi.**

E' comunque necessario, per adeguarsi alle norme di sicurezza, chiudere completamente le aperture che si dovessero formare tra il pavimento e il lato inferiore dello zoccolo e tra il pavimento e le fiancate della macchina quando la lavatrice è posizionata al termine di una linea di mobili.

**La copertura deve assolutamente impedire di toccare parti dell'impianto elettrico sotto tensione e deve richiedere l'uso di un utensile per essere tolta.**

**La nostra società declina ogni responsabilità per inosservanza delle predette norme di sicurezza.**

### **Applicazione dello zoccolo**

Lo zoccolo continuo dei mobili componibili dovrà essere removibile per permettere l'eventuale pulizia della pompa di scarico. In alcuni casi, lo zoccolo dei mobili componibili non è continuo, ma è limitato semplicemente alla larghezza della lavatrice. In questo caso, lo zoccolo del mobile può essere fissato allo zoccolo della lavatrice con 4 viti, rispettando i 4 riferimenti predisposti sul medesimo (**vedi fig. 9-10-11**).

**L'applicazione dello zoccolo dei mobili non deve prevedere l'eliminazione o la modifica dello zoccolo della lavatrice, ma quest'ultimo, per ragioni di sicurezza non può essere tolto e deve rimanere assolutamente integro e fissato alla lavatrice.**

---

## ASSEMBLY INSTRUCTIONS FOR BUILT-IN WASHING MACHINES

**IMPORTANT** - This machine complies with current safety regulations governing electrical appliances and, to ensure user safety, it must be installed by a qualified technician as required by current legislation

**Size of cabinet** The minimum dimensions of the cabinet are: height **820** mm, width **600** mm, depth **584** mm (fig. 1).

**Applying the panel** The panel may be attached to the left- or right-hand side of the washing machine (fig. 2)  
The machine is supplied fitted for a left-hand side panel attachment as the right-hand side is fitted with the push-pull lock (upper part) and the rubber pad (lower part).  
Should you wish to use the magnetic lock instead of the push-pull lock, remove the push-pull lock support and fit the supplied magnetic lock support.

**Important! Before fitting the panel (removing all the hinge and locking elements from the front) make sure the washing machine is totally disconnected from the mains power supply.**

**Warning** - To fix the panel on the right-hand side (direction of opening opposite to that of the door) dismount the push-pull lock (or the magnet lock) from the front of the machine and the rubber pad (fig. 3-A) and fit them on the opposite side (fig. 3-B).

All the elements applied to the front of the washing machine must be remounted correctly (no holes must remain open) in order to make it impossible to touch live components inside the machine.

**Our company declines all liability for failure to observe the above safety requirement.**

**Using the template**

- 1) Measure the height of the kitchen baseboard: the height of the wooden panel is obtained by first establishing the height of the kitchen baseboard.  
E.g.: for a **100** mm high baseboard, the maximum height of the panel is **720** mm. If the height of the baseboard must be increased, the height of the wooden panel must be reduced.

---

Place the template of the inner side of the panel and match the height of the baseboard with the lower edge of the panel (**fig. 4**) using the graduated scale. Make sure the template is horizontally centred with reference to the vertical lines marked at the ends.

After placing the template in the correct position, trace the positions of the following holes, pushing in with the tip of your pencil:

- holes for the hinges and hinge screws (**fig. 4**)
- holes for fixing the metal plate (if the magnetic lock is used), or the hook for the push-pull lock (**fig. 4, A - B**)

### Applying the panel elements and fixing the panel

- 1) Drill the holes for the hinges (**fig. 5**), the hook for the push-pull lock (**fig. 5**), or the metal plate if you decide to use the magnetic lock (**fig. 6**), and the holes for fixing the hinges (**fig. 6**).
- 2) The 13 mm depth of the 2 mm holes, for fixing the hinges and a metal plate for the magnet lock, only applies to the **solid wood** panel. For the **chipboard** panel, simply drill the upper coating – **fig. 6**.
- 3) Screw the two hinges to the panel (**fig. 7**)
- 4) Mount the hook for the push-pull lock or the metal plate for the magnet lock on the side opposite the hinges (**fig. 7**).
- 5) Fix the panel to the washing machine following the instructions shown in **fig. 8**.

### Adjusting the hinges

If, after applying the panel to the washing machine, it is slightly inclined or off-centre with respect to the front of the machine, correct its position by adjusting the mobile part of the hinges (**fig. 9**).

### Positioning the washing machine in the cabinet

Position the washing machine in the cabinet and, if necessary, adjust the feet to level it and lock them with the relative locknut. On appliances with adjustable rear feet, refer to the operator's manual.

To prevent the vibrations generated by the washing machine from being transmitted to the cabinet, make sure the sides and top do not touch the cabinet. **There must be a gap of at least 2 mm.** The back of the machine must also remain detached from the rear panel.

**If the cabinet is 870 mm high, the washing machine heightening kit on sale from the Spare Parts Service, must be used.**

To comply with safety legislation, any gaps between the floor and the bottom of the baseplate and between the floor and the sides of the machine when it is positioned at the end of a line of furniture must be completely closed.

**The cover must be installed in such a way as to make it**

---

**impossible to touch live components and a tool must be required to remove it.**

**Our company declines all liability for failure to observe the above safety requirement.**

### **Applying the baseboard**

It must be possible to remove the continuous kitchen baseboard to allow the drain pump to be cleaned if necessary.

In some cases, the baseboard is not continuous but limited to the width of the washing machine. In this case, the kitchen baseboard can be fixed to the washing machine baseboard with 4 screws, respecting the 4 reference marks (**see fig. 9-10-11**).

**When applying the kitchen baseboard, the washing machine baseboard may not be removed or adapted as, for reasons of safety, it must remain as it is, in one piece and fixed to the washing machine.**

---

## MONTAGEANLEITUNG FÜR EINBAUBARE WASCHMASCHINEN

**WICHTIG** – Die Waschmaschine entspricht den geltenden Sicherheitsvorschriften für elektrische Geräte und muss von einem Fachtechniker entsprechend den geltenden Normen installiert werden, um Gefahren für den Benutzer zu vermeiden.

**Abmessungen für den Einbau** Der Einbauraum muss wie folgt bemessen sein: Mindesthöhe **820mm**, Mindestbreite **600mm** und Mindestdiefe **584mm** (**Abb. 1**).

**Technische Angaben zur Montage der Platte** Die Platte kann entweder auf der linken oder auf der rechten Seite der Waschmaschine befestigt werden (**Abb. 2**)  
Die Waschmaschine wird für die linksseitige Befestigung der Platte geliefert. Auf der rechten Seite befinden sich das Verriegelungssystem Push-pull (im oberen Bereich) und das Gummi (im unteren Bereich).  
Wenn Sie anstatt der Push-pull Verriegelung die Magnetverriegelung benutzen möchten, muss die angebrachte Halterung entfernt und die mitgelieferte Halterung mit der Magnetverriegelung montiert werden.

**Wichtig! Während der Montagearbeiten der Platte (Entfernen aller Einzelteile der Scharniere und der Verriegelungen von der Frontplatte) muss die Waschmaschine unbedingt vom Stromnetz getrennt sein.**

**Hinweis** – Zur Befestigung der Platte auf der rechten Seite (Öffnungsrichtung umgekehrt zu der des Bullauges) müssen die Push-pull Verriegelung (bzw. der Magnet) sowie das Gummi (**Abb. 3-A**) von der Vorderseite abmontiert und auf der gegenüberliegenden Seite angebracht werden (**Abb. 3-B**).

Alle auf der Frontseite der Waschmaschine angebrachten Teile müssen wieder korrekt montiert werden (es darf kein Loch offen bleiben), um zu vermeiden, dass unter Spannung stehende Teile innerhalb der Waschmaschine berührt werden können.

**Bei Nichtbeachtung der oben genannten Sicherheitsvorschriften übernimmt unser Unternehmen keinerlei Haftung.**

**Gebrauch der Maske** 1) Die Höhe des Sockels der Küchenmöbel festlegen: Die Höhe der Holzplatte kann erst durch vorheriges Festlegen des Sockels der Küchenmöbel definiert werden.  
Beispiel: Einem **100mm** hohen Sockel entspricht eine maximale Höhe der Platte von **720mm**. Wenn die Höhe des Sockels vergrößert werden muss, die Höhe der Holzplatte verringern.

- 
- 2) Die Maske auf der Innenseite der Platte positionieren, und zwar so, dass die festgelegte Sockelhöhe mit der Unterkante der Platte übereinstimmt (**Abb. 4**), hierzu eine Mess-Skala benutzen. Die Maske muss auch horizontal zentriert sein, und zwar unter Bezugnahme auf die an den Enden markierten senkrechten Linien.
  - 3) Nach erfolgter Positionierung der Maske in der korrekten Position, die Positionen folgender Löcher mit der Spitze eines Bleistiftes einzeichnen:
    - Löcher für die Scharniere und die Befestigungsschrauben der Scharniere (**Abb. 4**)
    - Loch zur Befestigung des Metallplättchens (bei Verwendung der Magnetverriegelung) oder des Hakens für die Push-pull Verriegelung (**Abb. 4, A - B**)

### **Montage der Einzelteile auf der Platte und Befestigung der Platte**

- 1) An der Platte die Löcher zum Anbringen der Scharniere (**Abb. 5**), des Verschlussakens für die Push-pull Verriegelung (**Abb. 5**), oder des Metallplättchens für den eventuellen Gebrauch der Magnetverriegelung (**Abb. 6**) sowie die Löcher zur Befestigung der Scharniere bohren (**Abb. 6**).
- 2) Für die Platte aus **Massivholz** gelten folgende Maße: 13 mm tiefe Bohrlöcher mit einem Durchmesser von 2 mm, für die Befestigung der Scharniere und des Metallplättchens für den Magnet. Für die **Spanplatte** nur die obere Verkleidung anbohren - **Abb. 6**.
- 3) Die beiden Scharniere an der Platte anschrauben (**Abb. 7**)
- 4) Auf der gegenüberliegenden Seite der Scharniere den Verschlussaken für die Push-pull Verriegelung oder das Metallplättchen für den Magnet (**Abb. 7**) montieren.
- 5) Entsprechend den in der **Abb. 8** dargestellten Anleitungen die Platte an der Waschmaschine anbringen.

### **Einstellung der Scharniere**

Wenn die Platte nach der Montage an der Waschmaschine etwas schief oder nicht zentriert zum vorderen Teil der Maschine sitzt, die Plattenposition durch Regulierung des beweglichen Teils der Scharniere korrigieren (**Abb. 9**).

### **Positionierung im Einbauraum**

Die Waschmaschine in den Einbauraum einfügen, die Stellfüße ggf. drehen, um sie eben aufzustellen und dann die Stellfüße mit der entsprechenden Gegenmutter blockieren. Bei der Ausführung mit hinteren Stellfüßen die Gebrauchs- und Pflegeanleitung zu Rate ziehen.

Um zu verhindern, dass die Schwingungen des Gerätes auf die Möbel übertragen werden, in die die Maschine eingebaut ist, muss vermieden werden, dass die Seitenwände und der Ober- teil mit den Möbeln in Kontakt kommen, indem Sie **einen Abstand von mindestens 2 mm lassen**. Auch die Rückseite der Waschmaschine darf nicht die Rückwand berühren.

---

**Falls der Einbauraum eine Höhe von 870 mm haben sollte, ist der Bausatz zur Erhöhung der Waschmaschine zu verwenden. Der Bausatz ist mittels des Ersatzteilservice erhältlich.**

In Übereinstimmung mit den geltenden Sicherheitsvorschriften müssen die Öffnungen, die sich eventuell zwischen dem Fußboden und der Unterseite des Sockels sowie zwischen dem Fußboden und den Seitenwänden der Waschmaschine bilden, unbedingt geschlossen werden, sofern die Waschmaschine am Ende einer Möbellinie positioniert ist.

**Das Abdecken der Öffnungen soll vermeiden, dass die unter Spannung stehenden Teile der elektrischen Anlage berührt werden können. Zum Entfernen der Abdeckungen ein Werkzeug und niemals die Hände benutzen.**

**Bei Nichtbeachtung der oben genannten Sicherheitsvorschriften übernimmt unser Unternehmen keinerlei Haftung.**

#### **Anbringen des Sockels**

Der Sockel der Einbaumöbel muss entfernbare sein, um die Abwasserpumpe eventuell reinigen zu können.

In einigen Fällen, ist der Sockel der Einbaumöbel nicht an einem Stück bzw. ein einziges Teil, sondern einfach auf die Breite der Waschmaschine begrenzt, sodass der Möbelsockel mit 4 Schrauben am Waschmaschinensockel befestigt werden kann. Hierzu die 4 auf dem Sockel markierten Bezugspunkte beachten (**siehe Abb. 9-10-11**).

**Zum Anbringen des Möbelsockels niemals den Waschmaschinensockel entfernen oder umrüsten. Dieser muss absolut unversehrt und an der Waschmaschine befestigt bleiben.**



---

## INSTRUCTIONS DE MONTAGE DES LAVE-LINGE INTÉGRABLES

**IMPORTANT** - La machine est conforme aux normes de sécurité en vigueur en matière d'appareils électriques et doit être installée par un technicien qualifié conformément aux normes en vigueur, afin d'éviter tout risque pour l'utilisateur.

**Dimensions pour la pose** Les cotes du logement pour la pose doivent être : hauteur minimum **820** mm, largeur minimum **600** mm et profondeur minimum **584** mm (**fig. 1**).

**Informations techniques pour l'application du panneau** Le panneau peut être fixé soit du côté gauche soit du côté droit du lave-linge (**fig. 2**)  
La machine est fournie prévue pour le montage du panneau du côté gauche ; on trouve en effet sur la droite le système de fermeture « pousser-tirer » (dans la partie supérieure) et le butoir en caoutchouc (dans la partie inférieure).  
Si l'on veut utiliser la fermeture magnétique au lieu de la fermeture pousser-tirer, il faut enlever le support existant et monter le support fourni avec la fermeture magnétique.

**Important! Pendant les opérations pour l'application du panneau (démontage de toutes les pièces d'articulation et fermeture de la façade), il faut obligatoirement débrancher le lave-linge du réseau d'alimentation électrique.**

**Avertissement** - Pour fixer le panneau du côté droit (sens d'ouverture contraire à celui du hublot), il faut démonter la fermeture pousser-tirer (ou l'aimant) et le butoir (**fig. 3-A**) du devant de la machine et les appliquer du côté opposé (**fig. 3-B**).  
Toutes les pièces appliquées à la façade du lave-linge doivent être remontées correctement (il ne doit y avoir aucun trou ouvert) de façon à éviter tout risque de contact avec des composants sous tension à l'intérieur de la machine.

**Notre société décline toute responsabilité en cas d'inobservance des normes de sécurité susmentionnées.**

**Utilisation du gabarit**

- 1) Définir la hauteur de la plinthe de la cuisine : il faut d'abord définir cette cote pour obtenir la hauteur du panneau en bois.  
Exemple : avec une plinthe de **100** mm, la hauteur maximum du panneau est de **720** mm. S'il faut augmenter la hauteur de la plinthe, la hauteur du panneau en bois doit être diminuée en conséquence.

- 
- 2) Positionner le gabarit du côté interne du panneau et faire coïncider la hauteur de plinthe définie avec le côté inférieur du panneau (**fig. 4**) en utilisant l'échelle graduée. Le gabarit doit également être centré à l'horizontale, en se référant aux lignes verticales marquées dans les extrémités.
  - 3) Après avoir positionné le gabarit dans la position correcte, tracer les positions des trous indiqués ci-dessous avec la pointe d'un crayon :
    - trous pour les charnières et pour les vis de fixation des charnières (**fig. 4**) ;
    - trou de fixation de la plaquette métallique (quand on utilise la fermeture magnétique) ou du crochet de la fermeture pousser-tirer (**fig. 4, A - B**).

### **Application des pièces sur le panneau et fixation du panneau**

- 1) Sur le panneau, percer les trous pour l'application des charnières (**fig. 5**), du crochet de la fermeture pousser-tirer (**fig. 5**) ou de la plaquette métallique de la fermeture magnétique (**fig. 6**) et des vis de fixation des charnières (**fig. 6**).
- 2) La profondeur de 13 mm des trous diamètre 2 mm, pour la fixation des charnières et de la plaquette métallique pour l'aimant, se réfère au panneau en **bois massif**. Pour le panneau **en panneau de particules**, percer uniquement le revêtement supérieur – **fig. 6**.
- 3) Visser les deux charnières (**fig. 7**) sur le panneau.
- 4) Du côté opposé aux charnières, monter le crochet de la fermeture pousser-tirer ou la plaquette métallique pour l'aimant (**fig. 7**).
- 5) Fixer le panneau au lave-linge en suivant les instructions indiquées sur la **fig. 8**.

### **Réglage des charnières**

Si, après son application sur le lave-linge, le panneau est légèrement incliné ou décentré par rapport au devant de la machine, il est possible de corriger sa position en agissant sur la partie mobile des charnières (**fig. 9**).

### **Positionnement dans le logement d'encastrement**

Introduire le lave-linge dans le logement d'encastrement ; si nécessaire, tourner les pieds de façon à le mettre de niveau sur le plan horizontal, puis les bloquer avec le contre-écrou prévu à cet effet. S'il y a les pieds réglables arrière, consulter le manuel d'utilisation et d'entretien.

Afin d'éviter que les vibrations de l'appareil soient transmises aux meubles voisins, il faut éviter que les panneaux latéraux et le dessus entrent en contact avec ces meubles, **en veillant à laisser un espace libre d'au moins 2 mm**. L'arrière de la machine doit, lui aussi, rester à distance du mur.

**Si le logement d'encastrement a une hauteur de 870 mm, il faut utiliser le kit pour rehausser le lave-linge qui peut être acheté à travers le Service Pièces de rechange.**

---

Dans tous les cas, afin de se conformer aux normes de sécurité, il faut fermer complètement les éventuelles ouvertures entre le sol et le côté inférieur de la plinthe et entre le sol et les panneaux latéraux de la machine quand le lave-linge est positionné à la fin d'une ligne de meubles.

**L'habillage doit obligatoirement empêcher que des composants sous tension de l'installation électrique puissent être touchés et ne doit pouvoir être enlevé qu'avec un outil.**

**Notre société décline toute responsabilité en cas d'inobservance des normes de sécurité susmentionnées.**

**Application de la plinthe** La plinthe continue des meubles modulables doit être amovible, de façon à permettre l'éventuel nettoyage de la pompe de vidange.

Dans certains cas, la plinthe des meubles modulables n'est pas continue, mais limitée à la largeur du lave-linge. Dans ce cas, la plinthe du meuble peut être fixée à la plinthe du lave-linge avec 4 vis, en respectant les 4 repères indiqués sur celle-ci (**voir fig. 9-10-11**).

**L'application de la plinthe des meubles ne doit pas prévoir l'élimination ou la modification de la plinthe du lave-linge ; en effet, pour des raisons de sécurité, cette dernière ne peut pas être enlevée et doit obligatoirement être laissée intacte et fixée au lave-linge.**

---

## INSTRUCCIONES DE INSTALACIÓN DE LAS LAVADORAS INTEGRABLES

**IMPORTANTE** - La máquina cumple las normas de seguridad vigentes relativas a los aparatos eléctricos y debe ser instalada por un técnico especializado según las normas en vigor, a fin de evitar peligros para el usuario.

**Dimensiones para la introducción** Las cotas del vano de alojamiento deben ser: altura mínima **820mm**, anchura mínima **600mm** y profundidad mínima **584mm** (fig. 1).

### Información técnica para la instalación del panel

El panel se puede fijar por el lado izquierdo o por el lado derecho de la lavadora (fig. 2)

La máquina que se suministra está preparada para ensamblar el panel por el lado izquierdo; en efecto, en la derecha se encuentran el sistema de cierre push-pull (en la parte superior) y el elemento de goma (en la parte inferior).

Si se desea utilizar el cierre magnético en lugar del cierre push pull, es necesario desmontar el soporte existente e instalar el que forma parte del equipo base y que está dotado del cierre magnético.

**¡Importante! Durante las operaciones para la instalación del panel (desmontaje de la parte anterior de todas las piezas de engoznado y de cierre) la lavadora debe estar absolutamente desconectada de la red de alimentación eléctrica.**

**Advertencia** - Para fijar el panel por el lado derecho (sentido de apertura contrario al de la puerta) es necesario desmontar el cierre push pull (o el imán) y el elemento de goma (fig. 3-A) de la parte delantera de la máquina e instalarlos por el lado opuesto (fig. 3-B).

Es necesario volver a instalar de forma correcta todas las piezas instaladas por la parte anterior de la lavadora (ningún orificio debe estar abierto) para evitar absolutamente tocar las piezas bajo tensión en el interior de la máquina.

**Nuestra sociedad rechaza cualquier responsabilidad ante la no observancia de dichas normas de seguridad.**

### Uso de la máscara

1) Establecer la altura del zócalo de la cocina: la altura del panel de madera se obtiene tras haber establecido la altura del zócalo de la cocina.

Ejemplo: a un zócalo de **100mm** corresponde una altura máxima del panel de **720mm**. Si se debe aumentar la altura del zócalo, se deberá reducir la altura del panel de madera.

- 
- 2) Situar la máscara por el lado interior del panel y hacer coincidir la altura establecida del zócalo con el lado inferior del panel (**fig. 4**) mediante la escala graduada. La máscara se debe centrar también en sentido horizontal, haciendo referencia a las líneas verticales indicadas en los extremos.
  - 3) Tras haber situado la máscara en la posición correcta, trazar las posiciones de los siguientes orificios, entrando con la punta del lápiz:
    - orificios para las bisagras y para los tornillos de fijación de las bisagras (**fig. 4**)
    - orificio de fijación de la placa metálica (cuando se desea utilizar el cierre magnético) o del gancho para el cierre push pull (**fig. 4, A - B**)

### **Instalación de las piezas en el panel y fijación del panel**

- 1) Realizar en el panel los orificios para la instalación de las bisagras (**fig. 5**), del gancho de cierre para el cierre push pull (**fig. 5**) o de la placa metálica, si se desea utilizar el cierre magnético (**fig. 6**), y algunos orificios para la fijación de las bisagras (**fig. 6**).
- 2) La profundidad de 13mm de los orificios con diámetro de 2mm, para la fijación de las bisagras y de la placa metálica para el imán, tiene validez para el panel de **madera maciza**. Para el **panel de conglomerado** perforar solamente el revestimiento superior – **fig. 6**.
- 3) Enroscar las dos bisagras en el panel (**fig. 7**).
- 4) Instalar, por el lado opuesto a las bisagras, el gancho de cierre para el cierre push pull o la placa metálica para el imán (**fig. 7**).
- 5) Fijar el panel en la lavadora siguiendo las instrucciones de la **fig. 8**.

### **Regulación de las bisagras**

Si el panel, tras haberlo instalado en la lavadora, aparece ligeramente inclinado o descentrado respecto a la parte anterior de la máquina, es posible corregir su posición actuando sobre la parte móvil de las bisagras (**fig. 9**).

### **Colocación en el alojamiento de empotramiento**

Introducir la lavadora en el vano de empotramiento, girar los pies, si es necesario, para nivelarla sobre la superficie horizontal y bloquearlos con la contratuerca correspondiente. Si están presentes los pies regulables traseros, consúltese el manual de uso y mantenimiento.

Para impedir que las vibraciones del aparato se transmitan a los muebles en que está introducido, se debe evitar que los lados y la superficie superior entren en contacto con los muebles, **asegurándose de que permanezca una luz de por lo menos 2mm**. También la parte trasera de la máquina debe permanecer lejos de la pared trasera.

---

**Si el vano de empotramiento tiene una altura de 870 mm, se debe utilizar el kit de elevación de la lavadora que se puede comprar a través del Servicio de Recambios.**

En cualquier caso es necesario, para adecuarse a las normas de seguridad, cerrar completamente las aberturas que se formen entre el pavimento y el lado inferior del zócalo y entre el pavimento y los lados de la máquina cuando la lavadora está situada al final de una línea de muebles.

**El revestimiento debe impedir absolutamente tocar las piezas de la instalación eléctrica bajo tensión y debe requerir el uso de una herramienta para su desmontaje.**

**Nuestra sociedad rechaza cualquier responsabilidad ante la no observancia de dichas normas de seguridad.**

### **Instalación del zócalo**

El zócalo continuo de los muebles modulares deberá ser amovible para permitir la eventual limpieza de la bomba de descarga.

En algunos casos, el zócalo de los muebles modulares no es continuo, sino que está limitado simplemente a la anchura de la lavadora. En este caso, el zócalo del mueble se puede fijar en el zócalo de la lavadora con 4 tornillos, respetando las 4 referencias presentes en el mismo (véanse las figs. 9-10-11).

**La instalación del zócalo de los muebles no debe incluir la eliminación o la modificación del zócalo de la lavadora, pero este último, por razones de seguridad, no se puede desmontar y debe permanecer perfectamente íntegro y fijado en la lavadora.**

---

## INSTRUÇÕES DE MONTAGEM DAS MÁQUINAS DE LAVAR ROUPA INTEGRÁVEIS

**IMPORTANTE** – A máquina cumpre com as normas de segurança vigentes relativas aos aparelhos eléctricos e deve ser instalada por um técnico especializado de acordo com as normas em vigor, para evitar perigos para o utilizador.

**Dimensões para o encaixe** As medidas do compartimento de alojamento devem ser: altura mínima **820** mm, largura mínima **600** mm e profundidade mínima **584** mm (fig. 1).

**Informações técnicas para a aplicação do painel** O painel pode ser fixado no lado esquerdo ou, então, no lado direito da máquina de lavar roupa (fig. 2)  
A máquina é fornecida preparada para montar o painel no lado esquerdo; na realidade, na parte direita encontram-se o sistema de fecho “push-pull” (na parte superior) e a borracha (na parte inferior).  
Se desejar utilizar o fecho magnético no lugar do fecho “push pull”, é necessário cortar o suporte existente e montar o fornecido com o equipamento base que possui o fecho magnético.

**Importante! Durante as operações para aplicar o painel (desmontagem de todas as peças de charneira e de fecho da fachada) a máquina de lavar roupa, deve estar taxativamente desligada da rede de distribuição eléctrica.**

**Advertência** - Para fixar o painel no lado direito (sentido de abertura contrário ao da vigia) é necessário desmontar da parte anterior da máquina o fecho “push pull” (ou o íman) e a borracha (fig. 3-A) e aplicá-los no lado oposto (fig. 3-B).

Todas as peças aplicadas na fachada da máquina de lavar roupa devem ser remontadas correctamente (não deve estar aberto nenhum furo) para evitar, absolutamente, tocar partes sob tensão no interior da máquina.

**A nossa sociedade declina toda e qualquer responsabilidade pela inobservância das normas de segurança anteriormente referidas.**

**Uso da máscara** 1) Estabelecer a altura da base do fogão: a altura do painel de madeira é obtida estabelecendo-se primeiro a altura da base do fogão.  
Exemplo: para uma base de **100** mm corresponde uma altura máxima do painel de **720** mm. Se a altura da base deve ser aumentada, dever-se-á reduzir a altura do painel de madeira

- 
- 2) Colocar a máscara no lado interior do painel e fazer coincidir a altura da base estabelecida, com o lado inferior do próprio painel (**fig. 4**) com auxílio da escala graduada. A máscara deve estar centrada também no sentido horizontal, fazendo referência às linhas verticais marcadas nas extremidades.
  - 3) Depois de ter posicionado a máscara na posição correcta, traçar as posições dos seguintes furos, entrando com a ponta do lápis:
    - furos para charneiras e para os parafusos de fixação das charneiras (**fig.4**)
    - furo de passagem da chapa metálica (quando se deseja utilizar o fecho magnético), ou do gancho para o fecho “push pull” (**fig.4, A – B**)

### **Aplicação das peças no painel e fixação do painel**

- 1) Efectuar furos no painel para a aplicação das charneiras (**fig. 5**), do gancho de fecho para o fecho “push pull” (**fig. 5**), ou da chapa metálica se desejar utilizar o fecho magnético (**fig. 6**) e dos furos de fixação das charneiras (**fig. 6**).
- 2) A profundidade de 13 mm dos furos com diâmetro de 2 mm, para a fixação das charneiras e da chapa metálica para o íman, é válida para o painel de **madeira maciça**. Para o **painel de madeira aglomerada** perfurar somente o revestimento superior – **fig. 6**.
- 3) Aparafusar as duas charneiras (**fig. 7**) ao painel
- 4) Montar, no lado oposto das charneiras, o gancho de fecho para o fecho “push pull” ou a chapa metálica para o íman (**fig.7**)
- 5) Fixar o painel da máquina de lavar roupa seguindo as instruções da **fig.8**.

### **Regulação das charneiras**

Se o painel, uma vez aplicado à máquina de lavar roupa, se apresentar ligeiramente inclinado ou descentrado, em relação à parte anterior da máquina, é possível corrigir a sua posição agindo na parte amovível das charneiras (**fig.9**)

### **Localização do alojamento de encaixe**

Introduzir a máquina de lavar roupa no compartimento de encaixe, girar os pés se for necessário, para nivelá-la no plano horizontal e bloqueá-los com a contraporca fornecida para o efeito. Se a máquina estiver equipada com pés de apoio traseiros reguláveis, consulte o manual de uso e manutenção. Para impedir que as vibrações do aparelho se transmitam aos móveis em que está inserido, deve-se evitar que as partes laterais e o plano superior entrem em contacto com os próprios móveis, **acertando-se que reste uma abertura de pelo menos 2 mm**. A parte traseira da máquina também deve permanecer distante da parede posterior.



---

**Se o compartimento de encaixe possuir uma altura de 870 mm deve ser utilizado o kit para levantar a máquina de lavar roupa que pode ser comprado através do Serviço de Sobressalentes.**

Todavia, para conformar-se às normas de segurança, é necessário fechar completamente as aberturas que eventualmente se formassem entre o pavimento e o lado inferior da base e entre o pavimento e as partes laterais da máquina quando a mesma está localizada no fim de uma bateria de móveis.

**A cobertura deve impedir absolutamente de tocar nas partes do sistema eléctrico sob tensão e deve ser necessário o uso de uma ferramenta para retirá-la.**

**A nossa sociedade declina toda e qualquer responsabilidade pela inobservância das normas de segurança anteriormente referidas.**

#### **Aplicação da base**

A base contínua dos móveis componíveis deverá ser removível para consentir a limpeza da bomba de descarga.

Em alguns casos, a base do móveis componíveis não é contínua, mas está limitada simplesmente à largura da máquina de lavar roupa. Neste caso, a base do móvel pode ser fixada à base da máquina de lavar roupa com 4 parafusos, respeitando as 4 marcas efectuadas na mesma (ver fig. 9-10-11).

**A aplicação da base dos móveis deve prever a eliminação ou a modificação da base da máquina de lavar roupa, mas esta última, por motivos de segurança não pode ser retirada e deve ficar absolutamente intacta e fixada à máquina de lavar roupa.**

---

## MONTAGEINSTRUCTIES WASMACHINES

## VAN INTEGREERBARE

**BELANGRIJK** – De machine voldoet aan de veiligheidsvoorschriften betreffende elektrische apparatuur en moet volgens de geldende voorschriften door een gespecialiseerde monteur worden geïnstalleerd, om gevaar voor de gebruiker te voorkomen.

**Afmetingen voor de inbouw** De afmetingen van de inbouwruimte moeten zijn: minimumhoogte **820** mm, minimumbreedte **600** mm en minimumdiepte **584** mm (fig.1).

**Technische informatie voor het aanbrengen van het paneel** Het paneel moet aan de linker- of rechterkant van de wasmachine worden bevestigd (fig. 2)  
De machine wordt geleverd om het paneel links aan te brengen. Rechts bevinden zich namelijk het push-pull sluitsysteem (aan de bovenkant) en het rubber (aan de onderkant).  
Als u liever van de magneetsluiting dan van de push-pull sluiting gebruikmaakt, moet de bestaande steun worden verwijderd en de bijgeleverde met de magneetsluiting worden aangebracht.

**Belangrijk!** Tijdens de handelingen om het paneel aan te brengen (demontage van de voorkant van alle scharnier- en sluitingsonderdelen), moet de wasmachine persé van het elektriciteitsnet zijn gekoppeld.

**Waarschuwing** – Om het paneel aan de rechterkant (opening in de tegenovergestelde richting van die van het raampje) te bevestigen, moet de push-pull sluiting (of de magneet) en het rubber (fig. 3-A) van de voorkant van de machine worden gedemonteerd en aan de andere kant worden aangebracht (fig. 3-B).

Alle aan de voorkant van de wasmachine aangebrachte onderdelen moeten goed worden hermonteerd (geen gat mag open blijven), om te voorkomen dat onder stroom staande delen in de machine kunnen worden aangeraakt.

**Onze firma wijst elke vorm van aansprakelijkheid af voor niet-inachtneming van bovengenoemde veiligheidsvoorschriften.**

**De bescherming gebruiken** 1) Bepaal de hoogte van de voetlijst van de keuken: de hoogte van het houten paneel wordt verkregen door eerst de hoogte van de voetlijst van de keuken te bepalen.  
Bijvoorbeeld: met een voetlijst van **100** mm komt een paneel met een maximumhoogte van **720** mm overeen. Als de hoogte van de voetlijst moet toenemen, moet de hoogte van het houten paneel worden verminderd.

- 
- 2) Plaats de bescherming aan de binnenkant van het paneel en laat de vastgestelde hoogte van de voetlijst via de schaalverdeling overeenkomen met de onderkant van het paneel zelf (**fig. 4**). De bescherming moet ook horizontaal zijn gecentreerd. Houd u hierbij aan de verticale lijnen die aan de uiteinden zijn aangegeven.
  - 3) Na de bescherming op de juiste plaats te hebben aangebracht, geeft u met de punt van een potlood de plaats aan van de volgende gaten:
    - gaten voor de scharnieren en voor de bevestigingsschroeven van de scharnieren (**fig. 4**).
    - gaten ter bevestiging van het metalen plaatje (als u de magneetsluiting wenst te gebruiken), of van de haak voor de push-pull sluiting (**fig. 4, A - B**).

#### **De onderdelen op het paneel aanbrengen en het paneel bevestigen**

- 1) Boor de gaten in het paneel om de scharnieren (**fig. 5**), de haak voor de push-pull sluiting (**fig. 5**), of het metalen plaatje (**fig. 6**) aan te brengen, als u de magneetsluiting wilt gebruiken, en de gaten ter bevestiging van de scharnieren (**fig. 6**).
- 2) De diepte van 13 mm van de gaten met een doorsnede van 2 mm voor de bevestiging van de scharnieren en van het metalen plaatje voor de magneet gelden voor het **massief houten** paneel. Boor bij het **spaanplaat paneel** alleen gaten in de bovenste bekleding – **fig. 6**.
- 3) Schroef de twee scharnieren aan het paneel (**fig. 7**).
- 4) Monteer de sluithaak van de push-pull sluiting of het metalen plaatje voor de magneet aan de andere kant (**fig. 7**).
- 5) Bevestig het paneel aan de wasmachine en volg hierbij de instructies van **fig. 8**.

#### **De scharnieren afstellen**

Als het paneel, na het op de wasmachine te hebben aangebracht t.o.v. de voorkant van de machine een beetje schuin staat of niet helemaal in het midden, kan de stand via het bewegende gedeelte van de scharnieren worden gecorrigeerd (**fig. 9**).

#### **De wasmachine in de inbouwruimte zetten**

Zet de wasmachine in de inbouwruimte, draai indien nodig aan de pootjes om haar op een horizontaal oppervlak waterpas te zetten en zet ze met de contramoer vast. Bij regelbare pootjes achter moet u de gebruiks- en onderhoudsinstructies raadplegen.

Om te voorkomen dat trillingen van het apparaat overgaan op de meubels waarin het is ingebouwd, moet worden voorkomen dat de zijkanalen en het bovenblad in aanraking komen met de meubels zelf, **door u ervan te verzekeren dat er een ruimte**

---

van ten minste 2 mm overblijft. Ook de achterkant van de machine moet van de achterwand staan.

**Als de inbouwruimte een hoogte heeft van 870 mm, moet de verhogingskit van de wasmachine worden gebruikt, die verkrijgbaar is via de Reserveonderdelen Service.**

Om u aan de veiligheidsvoorschriften aan te passen, moeten de openingen die tussen de vloer en de onderkant van de sokkel en tussen de vloer en de zijkanten van de machine kunnen ontstaan volledig worden gesloten, als de wasmachine aan het eind van een reeks meubels is geplaatst.

**De bedekking moet voorkomen dat delen waar stroom op staat kunnen worden aangeraakt en er moet gereedschap voor nodig zijn om haar te verwijderen.**

**Onze firma wijst elke vorm van aansprakelijkheid af voor niet-inachtneming van bovengenoemde veiligheidsvoorschriften.**

#### **De voetlijst aanbrengen**

De doorlopende voetlijst van de montage-meubels moet kunnen worden verwijderd om de afvoer pomp eventueel te kunnen reinigen.

In sommige gevallen is de voetlijst van de montage-meubels niet doorlopend, maar eenvoudigweg beperkt tot de breedte van de wasmachine. In dit geval kan de voetlijst van het meubel met 4 schroeven aan de voetlijst van de wasmachine worden bevestigd. Neem hierbij de 4 referentiepunten erop in acht (**zie fig. 9-10-11**).

**Bij het aanbrengen van de voetlijst van de meubels mag de voetlijst van de wasmachine niet worden verwijderd of gewijzigd. Uit veiligheidsoverwegingen mag deze niet worden verwijderd en moet absoluut heel en aan de wasmachine bevestigd blijven.**

---

## MONTERINGSANVISNING FOR INTEGRERBARE VASKEMASKINER

**VIGTIGT** - Maskinen opfylder kravene i de gældende sikkerhedsstandarder vedrørende elektrisk udstyr og skal installeres af en specialuddannet tekniker med overholdelse af de gældende standarder for at undgå farer for brugeren.

**Indbygningsmål** Nichen skal have følgende mål: min. højde **820** mm; min. bredde **600** mm; min. dybde **584** mm (**fig. 1**).

### **Tekniske oplysninger vedrørende anbringelse af panel**

Panelet kan monteres på venstre eller højre side af vaskemaskinen (**fig. 2**).

Ved levering er maskinen forberedt til montering af panelet på venstre side. Push-pull låsesystemet er placeret øverst på højre side og stødpuden er placeret nederst på højre side.

Hvis Push-pull låsesystemet skal erstattes af magnetlåsen, er det nødvendigt at fjerne den eksisterende støtte og montere den medfølgende støtte, som bærer magnetlåsen.

**Vigtigt: Strømmen SKAL være koblet fra vaskemaskinen i forbindelse med anbringelse af panelet (fjernelse af alle hængsler og låse).**

**Forskrift** - For at montere panelet på højre side (modsat åbning i forhold til lågen) er det nødvendigt at fjerne Push-pull låsesystemet (eller magnetlåsen) og stødpuden (**fig. 3, A**) fra maskinens front. Montér delene på den modsatte side (**fig. 3, B**).

Alle dele på vaskemaskinens front skal genmonteres korrekt (ingen af hullerne må stå åbne) for at opnå fuldstændig beskyttelse mod kontakt med strømførende dele i maskinen.

**Producenten kan ikke gøres ansvarlig i tilfælde af manglende overholdelse af ovennævnte sikkerhedsforskrifter.**

### **Brug af skabe-lon**

1) Fastlæg højden på indbygningselementets sokkel: Træpanelets højde beregnes på baggrund af højden på indbygningselementets sokkel.

Eksempel: En sokkel på **100** mm svarer til et panel med en maks. højde på **720** mm. Hvis soklens højde skal øges, er det nødvendigt at reducere træpanelets højde.

- 
- 2) Anbring skabelonen indvendigt på panelet og sørg for, at den fastsætter sokkelhøjde flugter med panelets nederste kant (**fig. 4**). Benyt den gradinddelte skala. Skabelonen skal også centreres i vandret retning ved hjælp af de lodrette linier, som er afmærket i enderne.
  - 3) Når skabelonen er anbragt korrekt, optegnes placeringen af følgende huller ved hjælp af en blyant:
    - huller til hængsler og til hængslernes låseskruer (**fig. 4**);
    - hul til fastgørelse af metalpladen (ved brug af magnetlåsen) eller krogen (ved brug af Push-pull låsesystemet) (**fig. 4, A og B**).

#### **Anbringelse af dele på panel og montering af panel**

- 1) Bor hullerne til hængslerne (**fig. 5**) samt til krogen til Push-pull låsesystemet (**fig. 5**) eller til metalpladen til magnetlåsen (**fig. 6**) og hullerne til fastgørelse af hængslerne (**fig. 6**) i panelet.
- 2) Hullerne til fastgørelse af hængslerne og metalpladen til magnetlåsen skal have en dybde på 13 mm og en diameter på 2 mm. Disse mål gælder for et panel af **massivt træ**. I et panel af **spånplade** skal der kun bores i beklædningen (**fig. 6**).
- 3) Fastspænd de to hængsler på panelet (**fig. 7**).
- 4) Monter krogen til Push-pull låsesystemet eller metalpladen til magnetlåsen på den modsatte side af hængslerne (**fig. 7**).
- 5) Fastgør panelet til vaskemaskinen som vist i **fig. 8**.

#### **Justering af hængsler**

Hvis panelet efter montering på vaskemaskinen sidder skævt eller er forskudt i forhold til maskinens front, er det muligt at korrigere dets placering ved hjælp af hængslernes bevægelige del (**fig. 9**).

#### **Placering i nichen**

Anbring vaskemaskinen i nichen. Drej eventuelt fødderne for at nivellere maskinen og blokér dem ved hjælp af den tilhørende kontramøtrik.

For at hindre overførsel af vaskemaskinens vibrationer til elementerne, hvori maskinen er indbygget, må sidepanelerne og toppanelet ikke være i kontakt med elementerne. **Dette sikres ved at opretholde en afstand på min. 2 mm.** Der skal også være afstand mellem maskinens bageste del og bagvæggen.

**Hvis nichen har en højde på 870 mm, er det nødvendigt at benytte udstyret til hævnning af vaskemaskinen. Udstyret kan bestilles hos reservedelsafdelingen.**

Sikkerhedsforskrifterne foreskriver under alle omstændigheder, at åbningerne mellem gulvet og den nederste del af soklen og mellem gulvet og maskinens sidepaneler skal lukkes fuldstæn-

---

digt, hvis vaskemaskinen er i slutningen af en række elementer.

**Beklædningen skal hindre kontakt med de strømførende dele og skal kun kunne fjernes ved hjælp af værktøj.**

**Producenten kan ikke gøres ansvarlig i tilfælde af manglende overholdelse af ovennævnte sikkerhedsforskrifter.**

### **Anbringelse af sokkel**

Elementernes sammenhængende sokkel skal kunne fjernes således, at eventuel rengøring af afløbspumpen er mulig.

I enkelte tilfælde er der ikke tale om en sammenhængende sokkel til elementerne og soklen svarer i disse tilfælde kun til vaskemaskinens bredde. I dette tilfælde kan elementets sokkel fastgøres til vaskemaskinens sokkel med fire skruer ved at benytte de fire referencemærker på vaskemaskinens sokkel (se fig. 9, 10 og 11).

**Anbringelse af elementernes sokkel må ikke indebære fjernelse eller ændring af vaskemaskinens sokkel. Af hensyn til sikkerheden må vaskemaskinens sokkel ikke fjernes og den skal derfor forblive intakt og monteret på vaskemaskinen.**

---

# MONTERINGSANVISNINGAR FÖR INBYGGNADSBARA TVÄTTMASKINER

**VIKTIGT** - Maskinen överensstämmer med gällande säkerhetsföreskrifter angående elektrisk apparatur och ska installeras av en specialiserad tekniker i enlighet gällande föreskrifter för att skydda användaren mot faror.

**Dimensioner för inbyggnad** Måtten för utrymmet där tvättmaskinen ska byggas in: Min. höjd **820** mm, min. bredd **600** mm och min. djup **584** mm (**fig. 1**).

## Tekniska anvisningar för montering av panelen

Panelen kan fästas på tvättmaskinens vänstra eller högra sida (**fig. 2**)

Tvättmaskinen levereras förberedd för montering av panelen på vänster sida. På höger sida sitter på skjut-dragstängningen (på den övre delen) och gummipackningen (på den nedre delen). Om du vill använda magnetstängningen i stället för skjut-draglåsningsen, ta bort stödet som sitter på tvättmaskinen och montera det medlevererade stödet som bär den magnetiska stängningen.

**Viktigt! Under monteringen av panelen (nedmontering av alla gångjärns- och stängningsdelar på framsidan) ska tvättmaskinen vara fullständigt frånkopplad från elnätet.**

**Observera** - För att fästa panelen på höger sida (motsatt öppningsriktning i förhållande till luckan) måste skjut-dragstängningen (eller magnetstängningen) och gummipackningen monteras ned från tvättmaskinens framsida (**fig. 3-A**) och monteras på motsatt sida (**fig. 3-B**).

Alla delar som sitter på tvättmaskinens framsida ska monteras tillbaka på ett korrekt sätt (inget hål får lämnas öppet) för att undvika kontakt med spänningssatta delar inuti tvättmaskinen.

**Vårt företag avsäger sig allt ansvar vid försummelse av ovannämnda säkerhetsföreskrifter.**

## Användning av mallen

1) Fastställ kökssockelns höjd: Träpanelens höjd erhålls genom att först fastställa kökssockelns höjd.

Exempel: En sockel på **100** mm motsvarar en max. höjd för panelen på **720** mm. Om sockelns höjd måste ökas, ska träpanelens höjd minskas



- 2) Lägg mallen på panelens insida och se till att sockelns fastställda höjd sammanfaller med panelens nedre sida (**fig. 4**) med hjälp av den graderade skalan. Mallen ska även centreras i horisontell riktning, se de vertikala linjerna som är markerade i ändarna.
- 3) Efter att mallen har placerats i korrekt läge, ska följande hål markeras genom att sticka igenom mallen med spetsen på en blyertspenna:
  - Hål för gångjärnen och gångjärnens fästsruvar (**fig. 4**).
  - Hål för fastsättning av metallplattan (om du föredrar att använda den magnetiska stängningen) eller haken för skjut-dragstängningen (**fig. 4, A - B**).

### Montering av komponenter på panelen och fastsättning av panelen

- 1) Borra hål i panelen för att montera gångjärnen (**fig. 5**) för skjut-dragstängningens stängningshake (**fig. 5**), eller metallplattan om du föredrar att använda den magnetiska stängningen (**fig. 6**) och hålen för fastsättning av gångjärnen (**fig. 6**).
- 2) Djupet på 13 mm och diametern på 2 mm för gångjärnens fastsättningshål och magnetens metallplatta gäller för paneler av **massivt trä**. För **panel av spånplatta** ska endast den övre beläggningen borras igenom – **fig. 6**.
- 3) Skruva fast de två gångjärnen på panelen (**fig. 7**).
- 4) Montera stängningshaken för skjut-dragstängningen (eller metallplattan för magneten) på motsatt sida i förhållande till gångjärnen (**fig. 7**).
- 5) Fäst panelen på tvättmaskinen genom att följa anvisningarna i **fig. 8**.

### Justering av gångjärnen

Om panelen är något skev eller inte centrerad i förhållande till tvättmaskinens framsida efter att den har monterats på tvättmaskinen, kan panelens läge justeras med den rörliga delen på gångjärnen (**fig. 9**).

### Placering i inbyggnadsutrymmet

Sätt in tvättmaskin i inbyggnadsutrymmet. Vrid på stödbenen (om det är nödvändigt) för att nivellera tvättmaskinen på det horisontella planet och lås stödfötterna med den därtill avsedda låsmuttern. Om maskinen är försedd med bakre justerfötter, se bruks- och underhållsanvisningen.

För att förhindra att vibrationer överförs från tvättmaskinen till köksmöblerna där tvättmaskinen är inbyggd, ska man undvika att sidostyckena och det övre planet kommer i kontakt med köksmöblerna. **Kontrollera att det finns ett mellanrum på minst 2 mm runt tvättmaskinen.** Det ska

---

även finnas ett utrymme mellan tvättmaskinens bakstycke och den bakre väggen.

**Om inbyggnadsutrymmet har en höjd på 870 mm ska en sats för att höja tvättmaskinen användas. Denna sats kan inhandlas från reservdelsavdelningen.**

För att respektera gällande säkerhetsföreskrifter är det dessutom nödvändigt att stänga öppningarna fullständigt som kan bildas mellan golvet och maskinens sidostycken när tvättmaskinen placeras i slutet av en rad med köksmöbler.

**Övertäckningen ska göra det omöjligt att komma i kontakt med spänningssatta delar på elsystemet, och det ska krävas ett verktyg för att ta bort övertäckningen.**

**Vårt företag avsäger sig allt ansvar vid försummelse av ovannämnda säkerhetsföreskrifter.**

**Montering av sockel** Kontinuerlig sockel för kombimöbler ska kunna tas bort för eventuell rengöring av avloppspumpen.

I vissa fall är inte sockeln för kombimöbler kontinuerlig och sträcker sig endast över tvättmaskinens bredd. I detta fall kan möbels sockel fästas på tvättmaskinens sockel med 4 skruvar. Ta hänsyn till de 4 markeringarna på sockeln (se fig. 9-10-11).

**Vid montering av möbelsockeln får inte tvättmaskinens sockel tas bort eller modifieras. Av säkerhetsskäl får inte tvättmaskinens sockel tas bort och måste förbli hel och fastsatt på tvättmaskinen.**

---

## ANKASTRE ÇAMAŞIR MAKİNELERİ İÇİN MONTAJ TALİMATLARI

**ÖNEMLİ** – Bu makine elektrikli cihazlar için geçerli güvenlik düzenlemelerine uygundur ve kullanıcının güvenliğini sağlamak için yürürlükteki yasaların gerektirdiği şekilde yetkin bir teknisyen tarafından kurulmalıdır.

**Kabin ebadı** Kabinin asgari boyutları aşağıdaki gibidir:  
Yükseklik x Genişlik Derinlik (mm): 820 x 600 x 584 (**Şekil-1**)

**Panelin Takılması** Panel makinenin sol veya sağ tarafına takılabilir. (**Şekil-2**)  
Sağ tarafa çekme-itme kilidi (üst kısım) ve lastik taban (alt kısım) yerleştirilmiş olduğundan, makine paneli sol tarafa takılmaya uygun olarak gelir. Çekme-itme kilidi yerine manyetik kilidi kullanmak isterseniz, çekme-itme kilidinin desteğini sökün ve verilen manyetik kilit desteğini takın.

**Önemli! Paneli yerleştirmeden önce (ön yüzdeki tüm menteşe ve kilitleme elemanlarını sökerek), çamaşır makinesinin elektriğinin tamamen kesilmiş olduğundan emin olun.**

**Uyarı** – Paneli sağ tarafa yerleştirmek için (açılma yönü, kapı açılma yönünün tersinedir) çekme-itme kilidini (veya manyetik kilit) makinenin ön kısmından ve lastik yastıktan sökün (**Şekil-3-A**) ve karşı tarafa takın (**şekil 3-B**). Makinenin ön kısmına takılmış olan tüm elemanlar, makine içerisindeki elektrik yüklü parçalara dokunmayı olanaksız kılacak şekilde yeniden yerlerine takılmalıdır (hiçbir delik açık kalmamalıdır).

**Yukarıdaki güvenlik gerekliliklerinin yerine getirilmemesinden doğan arızalar için şirketimiz hiçbir yükümlülük kabul etmez.**

**Şablonunun kullanılması**

1) Mutfak süpürgeliğinin yüksekliğini ölçün; tahta panelin yüksekliğini elde edebilmek için önce mutfak süpürgeliğinin yüksekliği belirlenir.

Ör.: 100 mm yüksekliğindeki bir süpürgelik için panelin yüksekliği 720 mm.dir. Süpürgelik yüksekliğinin artırılması gerekiyorsa, tahta panel yüksekliğinin indirilmesi şarttır.

- 2) Panelin iç yüzünün şablonunu yerleştirin ve derece ölçüğünü kullanarak süpürgeliğin yüksekliğini panelin alçak kenarıyla (**Şekil-4**) karşılaştırın. Uçlara konulmuş dikey çizgilere bakarak şablonun yatay olarak ortalandığından emin olun.
- 3) Şablonu doğru şekilde yerleştirdikten sonra, kaleminizin ucuyla iterek aşağıdaki deliklerin konumlarını belirleyin:
  - menteşe ve menteşe vidası yuvalarının delikleri (**Şekil-4**)
  - metal plakayı sabitleyeceğiniz delikler (manyetik kilit kullanılıyorsa), veya itme-çekme kilidi kancası (**Şekil-4, A - B**)

### **Panel elemanlarının takılması ve panelin sabitlenmesi**

- 1) Menteşe deliklerini delin (**Şekil- 5**) itme-çekme kilit kancası (**Şekil- 5**) veya metal plaka – manyetik kilidi kullanmaya karar vermişseniz (**Şekil-6**) ve menteşelerin sabitleneceği delikleri sabitleyin (**Şekil-6**).
- 2) Menteşelerin ve manyetik kilit için metal plakanın sabitleneceği 2 mm.lik deliklerin 13 mm.lik derinliği yalnızca **masif tahta panel** için geçerlidir. **Sunta panel** için sadece üst kaplamayı delmeniz yeterlidir – (**Şekil-6**).
- 3) İki adet menteşeyi panele vidalayın (**Şekil-7**)
- 4) İtme-çekme kilidi kancasını ya da manyetik kilidin metal plakasını menteşelerin takıldığı yerin karşı tarafına monte edin (**Şekil-7**).
- 5) **Şekil-8**'de verilen talimatları uygulayarak paneli çamaşır makinesine sabitleyin.

### **Menteşelerin ayarlanması**

Paneli çamaşır makinesine takmanızdan sonra hafifçe eğik duruyorsa ya da makinenin ön yüzüne göre merkezlenmemişse, menteşelerin hareketli parçalarını ayarlayarak bu çarpıklığı giderin (**Şekil-9**).

### **Çamaşır makinesinin kabine yerleştirilmesi**

Çamaşır makinesini kabine yerleştirin ve gerekirse, dengelemek için ayaklardan ayarlayarak ilgili kilit somunuyla kilitleyin. Çamaşır makinesinde meydana gelen titreşimlerin kabine iletilmesini önlemek için yan tarafların ve üstünün kabine temas etmediğinden emin olun. **Arada en az 2 mm.lik bir açıklık olmalıdır.** Bunların yanı sıra, makinenin arkası da arka panelden ayrı durmalıdır.

**Kabin yüksekliği 870 mm ise, Yedek Parça Servisimizden edinebileceğiniz makine yükseltme kitini kullanmanız gerekir.**

Güvenlik yasalarına uygun olması bakımından, makine

---

bir dizi mobilyanın ucuna yerleştirildiğinde zeminle taban levhası arasında ve zeminle makinenin yan tarafları arasında kalan her türlü açıklığın tamamen kapatılması gerekir.

**Kapak, elektrikli parçalara temas edilmesini olanaksız kılacak şekilde takılmalı ve bunu çıkarmak için alet yardımı şart olmalıdır.**

**Yukarıdaki güvenlik gerekliliklerinin yerine getirilmemesinden doğan arızalar için şirketimiz hiçbir yükümlülük Kabul etmez.**

**Süpürgeliğin  
ması**

**takıl-**

Gerektiğinde tahliye pompasının temizlenebilmesi için sürekli mutfak süpürgeliği çıkarılabilir özellikte olmalıdır. Bazı durumlarda bu süpürgelik sürekli olmayıp, yalnızca çamaşır makinesinin genişliği kadar olabilir. Bu durumda, mutfak süpürgeliği, 4 referans noktasından 4 vida ile çamaşır makinesinin süpürgeliğine sabitlenebilir (**bkz. Şekil- 9-10-11**).

**Mutfak süpürgeliği takılırken, çamaşır makinesinin süpürgeliği güvenlik nedenleriyle olduğu gibi tek parça halinde bırakılmak zorunda olduğundan ve yerinden sökülemeyeceğinden bunun çamaşır makinesine sabitlenmesi gerekir.**

---

## ИНСТРУКЦИИ ПО МОНТАЖУ ВСТРОЕННЫХ СТИРАЛЬНЫХ МАШИН

**ВАЖНО** - Машина отвечает действующим нормам безопасности в области электрического оборудования и должна устанавливаться квалифицированным специалистом по действующим нормам, чтобы избежать опасность для пользователя.

**Размеры для установки** Размеры отсека для установки машины должны быть следующими: минимальная высота **820** мм, минимальная ширина **600** мм и минимальная глубина **584** мм (рис. 1).

**Техническая информация для установки панели** Панель может устанавливаться слева или справа от стиральной машины (рис. 2)  
Машина поставляется подготовленной для установки панели на левой стороне. Справа находится нажимной замок (в верхней части) и упор (в нижней части).  
При необходимости использования магнитного запора вместо нажимного замка необходимо снять существующую опору и установить запасную, с магнитным замком.

**Важно! Выполняя операции по установке панели (демонтаж с лицевой части всех деталей шарниров и закрытия), посудомоечная машина должна быть обязательно отключена от электрической сети.**

**Предупреждение** - Для крепления панели справа (открытие в противоположную сторону по сравнению с люком) необходимо снять с передней стороны машины нажимной замок (или магнит) и упор (рис. 3-А) и установить их на противоположную сторону (рис. 3-В).

Все детали, установленные на лицевую сторону стиральной машины, должны быть правильно установлены на новое место (ни одно отверстие не должно оставаться открытым), чтобы категорически исключить возможность прикосновения к частям под напряжением внутри машины.

**Наша компания не несет никакой ответственности за несоблюдение данных норм безопасности.**

**Использование кондуктора** 2) Определите высоту плинтуса кухонной мебели: высота деревянной панели определяется после измерения высоты плинтуса мебели.  
Например: плинтусу в **100** мм соответствует максимальная высота панели **720** мм. Если высота плинтуса должна быть увеличена, необходимо уменьшить высоту деревянной панели.

- 
- 4) Наложите кондуктор на внутреннюю сторону панели и совместите измеренную высоту плинтуса с нижней стороной панели (**рис. 4**) при помощи градуированной шкалы. Кондуктор должен быть отцентрован также и по горизонтали, ориентируясь по вертикальным линиям по краям.
  - 5) Установив кондуктор в правильное положение, нанесите положение следующих отверстий острием карандаша:
    - отверстий для петель и для крепежных винтов петель (**рис. 4**)
    - крепежного отверстия металлической пластины (когда необходимо использовать магнитный замок) или ответной части для нажимного замка (**рис. 4, А - В**)
  - 6) Просверлите в панели отверстия для установки петель (**рис. 5**), ответной части замка для нажимного замка (**рис. 5**) или же металлическую пластину, если используется магнитный замок (**рис. 6**), а также отверстия для крепления петель (**рис. 6**).
  - 7) Глубина 13 мм отверстий диаметром 2 мм для крепления петель и металлической пластины для магнита действительна для панели из **натурального дерева**. Для **панели из ДСП** просверлите лишь только наружную облицовку - **рис. 6**.
  - 8) Привинтите к панели две петли (**рис. 7**).
  - 9) На противоположной стороне петель установите ответную часть нажимного замка или же металлическую пластинку для магнита (**рис. 7**).
  - 10) Прикрепите панель к стиральной машине, выполняя инструкции **рис. 8**.

#### **Установка деталей на панель и крепление панели**

#### **Регулировка петель**

Если после установки на стиральную машину панель слегка наклонена или же смещена относительно передней стороны машины, то ее положение можно исправить при помощи подвижной части петель (**рис. 9**).

#### **Установка в проем для встроенной установки**

Вставьте стиральную машину в проем для встроенной установки, при необходимости вращайте ножки для регулировки машины по горизонтали и заблокируйте их специальными контргайками. При наличии задних регулируемых ножек обращайтесь к руководству по эксплуатации и обслуживанию.

Чтобы вибрация стиральной машины не передавалась на мебель, в которую она встроена, следует избегать, чтобы боковины и верхняя панель касались мебели, **проверяя, чтобы оставался зазор не менее 2 мм**. Также и задняя

---

сторона машины должна находиться на расстоянии от задней стенки мебели.

**Если проем для встроенной установки имеет высоту 870 мм, то необходимо использовать комплект для подъема стиральной машины, который можно приобрести в Службе запасных частей.**

Для обеспечения соответствия нормам безопасности необходимо полностью закрыть проемы, которые могут образоваться между полом и нижней кромкой плинтуса, а также между полом и боковинами машины, когда стиральная машина находится в конце гарнитура мебели.

**Закрывающие панели ни в коем случае не должны допускать контакт с частями электрической системы под напряжением, а чтобы снять панели, необходимо использовать инструмент.**

**Наша компания не несет никакой ответственности за несоблюдение данных норм безопасности.**

#### **Установка плинтуса**

Сплошной плинтус модульной мебели должен быть съемным, чтобы обеспечить возможность очистки сливного насоса.

В некоторых случаях плинтус модульной мебели не сплошной и ограничивается шириной стиральной машины. В этом случае плинтус мебели может быть прикреплен к плинтусу стиральной машины 4 винтами, используя для этого имеющиеся на нем 4 метки (см. рис. 9-10-11).

**Установка плинтуса мебели не должна приводить к удалению или изменению плинтуса стиральной машины, который по причинам безопасности не должен сниматься, должен оставаться в полной сохранности и быть прикрепленным к стиральной машине.**



---

## INSTRUKCJA MONTAŻU PRALEK DO ZABUDOWY

**WAŻNE** - Urządzenie spełnia przepisy bezpieczeństwa obowiązujące w zakresie sprzętu elektrycznego i musi być zainstalowane przez wykwalifikowanego technika, zgodnie z obowiązującymi przepisami, aby zapobiec zagrożeniom dla użytkownika.

**Wymiary do zabudowy** Wymiary wnęki do zabudowy muszą być następujące: minimalna wysokość **820mm**, minimalna szerokość **600mm** i minimalna głębokość **584mm (rys. 1)**.

**Informacje techniczne dotyczące założenia panelu** Panel może być zamocowany z lewej lub prawej strony pralki (**rys. 2**)  
Dostarczone urządzenie jest przystosowane do zamontowania panelu z lewej strony; po prawej stronie znajduje się bowiem mechanizm zamykający push-pull (w części górnej) i gumowa podkładka (w części dolnej).  
Jeśli zamiast mechanizmu push-pull chcemy używać magnetycznego mechanizmu zamykającego, należy usunąć istniejący uchwyt i zamontować dostarczony uchwyt mechanizmu magnetycznego.

**Ważne! Podczas czynności związanych z zakładaniem panelu (usunięcie z części przedniej wszystkich elementów zawiasów i zamykania) pralka musi być bezwzględnie wyłączona z sieci zasilającej.**

**Ostrzeżenie** - Aby zamocować panel po prawej stronie (kierunek przeciwny do kierunku otwierania drzwiczek pralki), należy wymontować z przedniej części urządzenia mechanizm typu push-pull (lub magnetyczny) oraz element gumowy (**rys. 3-A**) i założyć je po przeciwległej stronie (**rys. 3-B**).

Wszystkie elementy z przedniej części pralki muszą być zamocowane prawidłowo (żaden otwór nie może pozostać pusty), aby zapobiec stykaniu się części pod napięciem wewnątrz urządzenia.

**Firma nasza nie ponosi żadnej odpowiedzialności za nieprzestrzeganie powyższych norm bezpieczeństwa.**

**Korzystanie z szablonu**

- 1) Ustalić wysokość listwy kuchni: wysokość drewnianego panelu uzyskuje się przez uprzednie ustalenie wysokości listwy kuchni.  
Przykład: listwie **100mm** odpowiada maksymalna wysokość panelu równa **720 mm**. Jeżeli wysokość listwy musi być zwiększona, należy zredukować wysokość drewnianego panelu

- 
- 2) Umieścić szablon na wewnętrznej stronie panelu i przy pomocy podziałki dopasować ustaloną wysokość listwy do dolnej części tegoż panelu (**rys. 4**). Szablon musi być wypośrodkowany również w kierunku poziomym w oparciu o linie pionowe zaznaczone na końcach.
  - 3) Po umieszczeniu szablonu w prawidłowym położeniu wyznaczyć położenie następujących otworów, wsuwając w nie końcówkę ołówka:
    - otwory do zawiasów i do śrub mocujących zawiasy (**rys. 4**)
    - otwór na płytkę metalową (jeśli chcemy używać magnetyczny mechanizm zamykania) lub zaczep do mechanizmu push pull (**rys. 4, A - B**)

### **Zamocowanie detali na panelu i zamocowanie panelu**

- 1) Wywiercić na panelu otwory do założenia zawiasów (**rys. 5**), zaczepu mechanizmu push pull (**rys. 5**) lub metalowej płytki, jeśli chcemy używać mechanizmu zamykania magnetycznego, (**rys. 6**) oraz otwory do mocowania zawiasów (**rys. 6**).
- 2) Głębokość 13 mm i średnica 2mm otworów do mocowania zawiasów i płytki metalowej na magnes obowiązują dla panelu z **litego drewna**. W przypadku **plyty wiórowej** wywiercić tylko górną okładzinę (**rys. 6**).
- 3) Przykręcić do panelu dwa zawiasy (**rys. 7**)
- 4) Zamocować po stronie przeciwnej zaczep dla mechanizmu zamykania push pull lub metalową płytkę dla magnesu (**rys. 7**)
- 5) Zamocować panel do pralki zgodnie z instrukcjami (**rys. 8**).

### **Regulacja zawiasów**

Jeśli po przymocowaniu do pralki panel byłby lekko przechylony lub przesunięty względem przedniej części, można to poprawić, regulując ruchomą część zawiasów (**rys. 9**).

### **Pozycjonowanie w miejscu zabudowy**

Umieścić pralkę we wnęce dla niej przeznaczonej, obrócić nóżki, aby ją wypoziomować i zamocować je odnośnymi nakrętkami. W przypadku regulowanych nóżek tylnych skonsultować instrukcję obsługi i konserwacji.

Żeby zapobiec przekazywaniu wibracji pralki do mebli, między którymi została zainstalowana, należy uniemożliwić, aby boki i górna powierzchnia stykały się z tymiż meblami, **upewniając się, że pozostanie prześwit rzędu co najmniej 2mm**. Również tylna część urządzenia nie może dotykać tylnej ściany. **Jeśli wnęka ma wysokość 870 mm, musi zostać zastosowany zestaw podwyższający pralkę, który można nabyć za pośrednictwem Ośrodka Serwisowego.**

W celu spełnienia norm bezpieczeństwa należy w każdym razie całkowicie zamknąć otwory, które mogłyby powstać między podłogą i dolną częścią listwy oraz po bokach urządzenia, jeżeli

---

pralka została umieszczone na końcu danego ciągu mebli.  
**Ostona musi bezwzględnie zapobiegać stykaniu części instalacji elektrycznej pod napięciem i musi wymagać użycia narzędzi do jej usunięcia.**  
**Firma nasza nie ponosi żadnej odpowiedzialności za nieprzestrzeganie powyższych norm bezpieczeństwa.**

#### **Zakładanie listwy**

Ciągła listwa zestawu mebli kuchennych musi być wyjmowana w celu umożliwienia ewentualnego czyszczenia pompy spustowej.

W niektórych przypadkach listwa zestawu mebli kuchennych nie jest ciągła, lecz jest po prostu ograniczona do szerokości pralki. W przypadku takim listwa mebla może być zamocowana do listwy pralki 4 śrubami, przestrzegając 4 punktów odniesienia na niej umieszczonych (**patrz rys. 9-10-11**).

**Założenie listwy mebli nie musi przewidywać eliminacji lub modyfikacji listwy pralki, lecz ta ostatnia ze względów bezpieczeństwa nie może zostać usunięta oraz musi pozostać nienaruszona i zamocowana do pralki.**

## تعليمات تركيب الغسالات المدمجة

ملاحظة هامة - تتوافق الآلة مع القوانين السارية المفعول في مجال السلامة المتعلقة بالأجهزة الكهربائية و يتوجب تركيبها من قبل تقني متخصص بموجب القوانين السارية المفعول لغرض تجنب تعرض المستخدم الى المخاطر.

قياسات التركيب داخل الإثاث

يجب ان تكون قياسات الاثاث/الخرزانة حيث سيتم وضع الآلة كما يلي: الحد الأدنى للارتفاع 820 ملم، الحد الأدنى للعرض 600 ملم و الحد الأدنى للعمق 584 ملم (الشكل 1).

### معلومات تقنية لوضع اللوح

يجوز تثبيت اللوح من الجهة اليمنى أو الجهة اليسرى لغسالة الملابس (الشكل 2) يتم تزويد الآلة بالتجهيزات اللازمة لتركيب اللوح على الجهة اليسرى، ففي الواقع يتوفر على الجهة اليمنى نظام الاغلاق بالدفع-السحب (في الجزء العلوي) و حشبية من المطاط (في الجزء السفلي).  
إذا رغب في استخدام نظام الاغلاق المغناطيسي بدلاً من نظام الاغلاق بالدفع-السحب، يتوجب ازالة الركيذة الموجودة مسبقاً و تركيب المزودة خصيصاً لنظام الاغلاق المغناطيسي.

هام! خلال اجراءات تركيب لوح (فك كافة عناصر المفاصل و نظام الاغلاق) الغسالة يتوجب ان تكون مفصولة كلياً من مأخذ التيار الكهربائي.

تحذير – لتثبيت اللوح على الجهة اليمنى (اتجاه فتح معاكس لاتجاه باب الغسالة الدائري) يتوجب فك نظام الاغلاق بالدفع-السحب (أو المغناطيسي) و الحشبية المطاطية (الشكل A-3) من الجزء الامامي للآلة و تركيبهم على الجهة المعاكسة (الشكل B-3).  
يتوجب اعادة تركيب كافة العناصر الموجودة على واجهة الغسالة بالشكل الصحيح) يجب ان لا يبقى أي ثقب مفتوح (وذلك لتجنب ملامسة الاجزاء الخاضعة للتوتر او المتحركة الموجودة داخل الآلة كلياً.  
لا تتحمل شركتنا أي مسؤولية ناجمة عن عدم الالتزام بأنظمة قوانين السلامة المذكورة مسبقاً.

### استعمال القالب

1) تحديد ارتفاع لوح قاعدة اثاث المطبخ: يتم الحصول على ارتفاع لوح الخشب بالتحديد أولاً لارتفاع لوح قاعدة أثاث المطبخ.  
مثال: يتوافق لوح قاعدة قياسه 100 ملم مع حد اقصى لقياس ارتفاع اللوح 720 ملم .  
في حالة لزوم زيادة ارتفاع لوح القاعدة يتوجب خفض ارتفاع لوح الخشب.

يوضع القالب على الجهة الداخلية للوح بحيث يتم العمل على توافق ارتفاع لوح القاعدة المحدد مع الجهة السفلية لنفس اللوح (الشكل 4) عن طريق مقياس مدرج. يتوجب وضع القالب بشكل متمركز أفقياً باتخاذ الخطوط العمودية المسجلة على النهايات كمرجع. بعد وضع القالب بالوضعية الصحيحة يتم تحديد مواقع الثقوب التالية وذلك بإدخال رأس قلم الرصاص و رسم :

- ثقوب المفاصل و براغي تثبيت المفاصل (الشكل 4)
- ثقب تثبيت الصفيحة المعدنية (إذا رغب باستعمال نظام الاغلاق المغناطيسي) أو مشبك نظام الاغلاق بالدفع-السحب (الشكل 4، B-A)

- تركيب العناصر الخاصة على اللوح و تثبيت اللوح.**
- 1 تنفيذ الثقوب على اللوح لتركيب مفاصل (الشكل 5) المشبك المتعلقة بنظام الاغلاق بالدفع -السحب (الشكل 5) أو الصفيحة المعدنية إذا رغب في تركيب نظام الاغلاق المغناطيسي (الشكل 6) و ثقوب تركيب المفاصل (الشكل 6).
  - 2 يعتبر قياس عمق الثقوب 13 ملم و قياس قطر 2 ملم اللازم لتثبيت المفاصل و الصفيحة المعدنية للمغناطيس صالح فقط للوح المصنوع من الخشب الصلب. فأمّا بالنسبة الى اللوح المصنوع من الخشب المضغوط يتوجب العمل على اجراء ثقب على طبقة التغطية العلوية فقط - الشكل 6.
  - 3 العمل على شد براغي كلا المفصلين بتثبيت على اللوح (الشكل 7)
  - 4 تركيب مشبك الاغلاق لنظام الدفع-السحب أو الصفيحة المعدنية للمغناطيس على الجهة المعاكسة للمفاصل (الشكل 7).
  - 5 تثبيت اللوح على غسالة الملابس باتباع تعليمات الشكل 8.

**ضبط المفاصل**

إذا لوحظ بعد تركيب اللوح على الغسالة بأنه مائل قليلاً أو غير متمركز بالنسبة الى الجزء الامامي للآلة من الممكن تصحيح وضعيته عن طريق اجراءات تتم على الجزء المتحرك للمفاصل (الشكل 9).

**وضع الغسالة في الاثاث او الخزانة.**

ادخال الغسالة في الحيز المخصص لها بإدارة الاقدام - إذا لزم الامر - وذلك لضبط وضعيتها بمستوى افقي و احكام تثبيتهم عن طريق صمولة التثبيت الخاصة. في حالة وجود اقدام خلفية قابلة للضبط يتوجب مراجعة كتيب الاستعمال و الصيانة . لمنع انتقال تذبذبات/اهتزازات الغسالة الى الاثاث الذي تم وضع الغسالة بداخله، يتوجب تجنب ملامسة جوانبها و سطحها العلوي مع نفس الاثاث وذلك بضمان مسافة 2 ملم من الفراغ الفاصل ما بينهم كحد ادنى. و يجب ان تبقى الجهة الخلفية للغسالة ايضاً بعيدة عن اللوح الخلفي.

إذا كان ارتفاع الخزانة او الحيز 870 ملم ،يتوجب استخدام طقم رفع الغسالة الذي يمكن شراؤه عن طريق خدمة قطع الغيار.

وفي كافة الاحوال و للتوافق مع أنظمة قوانين السلامة، يتوجب الاغلاق الكامل لكافة الفتحات التي من الممكن ان تتشكل ما بين الارضية و الجهة السفلية للوح القاعدة و ما بين الارضية و جوانب الآلة، وذلك عندما تكون الغسالة موضوعة على نهاية خط الاثاث. يجب ان تتم عملية التغطية بحيث تمنع كلياً من ملامسة اجزاء التجهيزات الكهربائية الواقعة تحت جهد/المتحركة و بحيث يستلزم استخدام اداة لإزالتها.

لا تتحمل شركتنا أي مسؤولة ناجمة عن عدم الالتزام بأنظمة قوانين السلامة المذكورة مسبقاً.

يجب ان يكون لوح القاعدة الخاص باستمرارية الاثاث قابل للإزالة من مكانه و ذلك للسماح بتنظيف مضخة التصريف عند اللزوم.

في بعض الحالات يكون لوح قاعدة الاثاث المركب غير متواصل و لكنه ببساطة محدود على عرض الغسالة فقط. في هذه الحالة يجوز تثبيت لوح قاعدة الاثاث بلوح قاعدة الغسالة بواسطة 4 براغي وذلك بالتقيد بالمراجع المحددة عليه (انظر الى الشكل 9-10-11)

لا يقتضي وضع لوح قاعدة الاثاث على التخلص او تعديل لوح قاعدة الغسالة، ولكن لا يتوجب ازالة الاخير لأسباب المحافظة على السلامة و يجب ان يبقى كما هو و ذلك على شكل قطعة واحدة مثبتة على الغسالة.

**1**

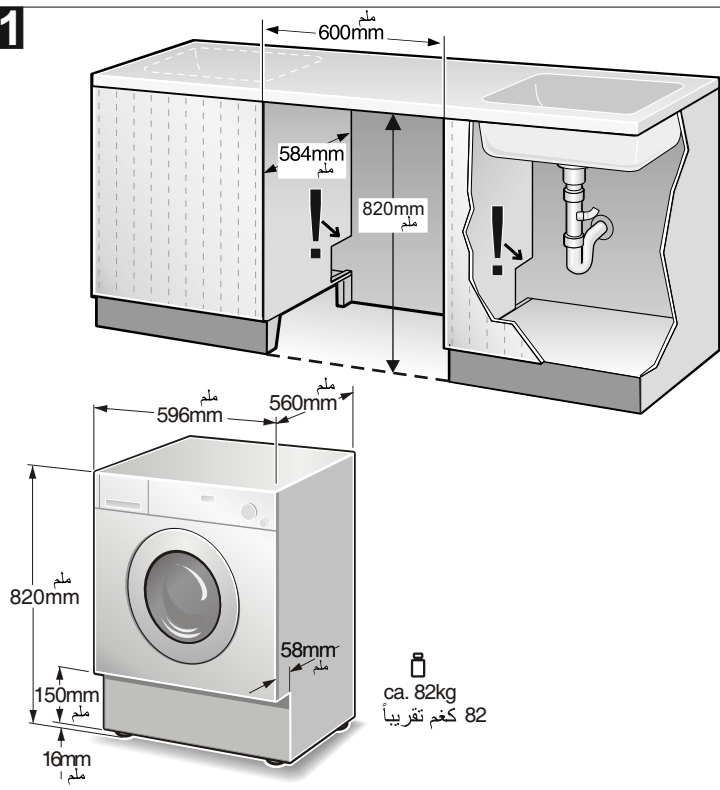

**2**

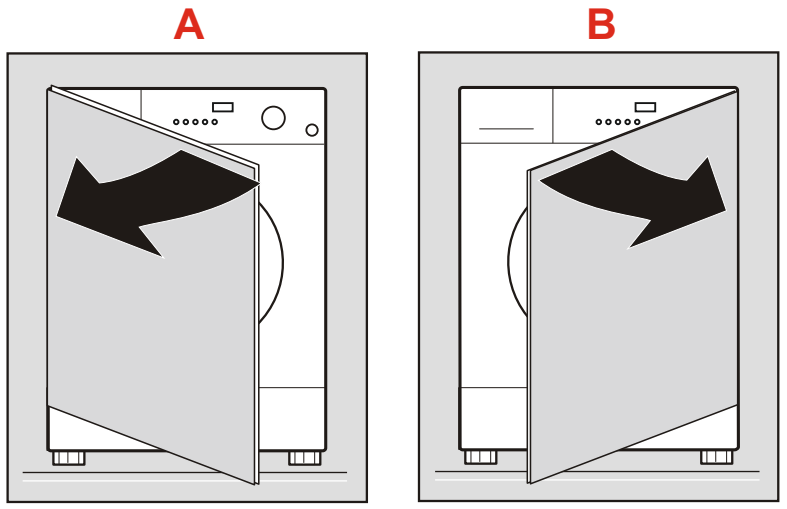

**3**

**3 - A**

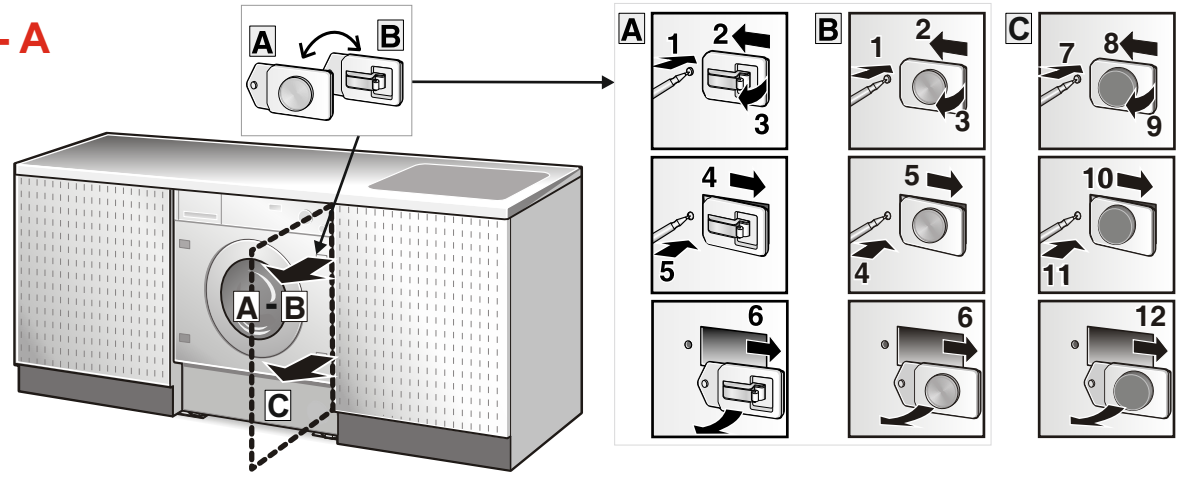
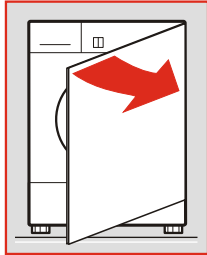

**3 - B**

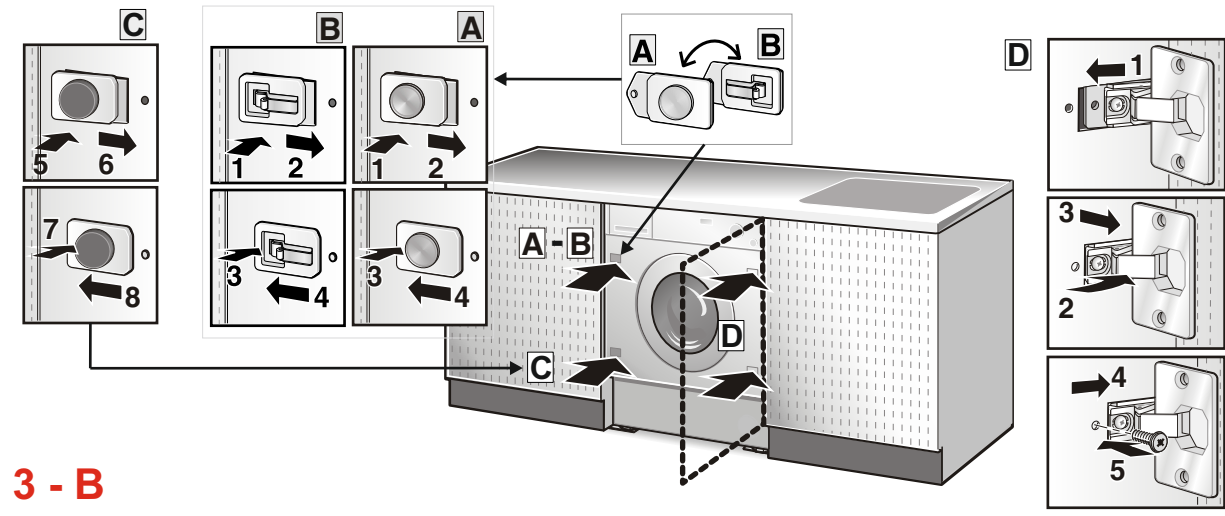



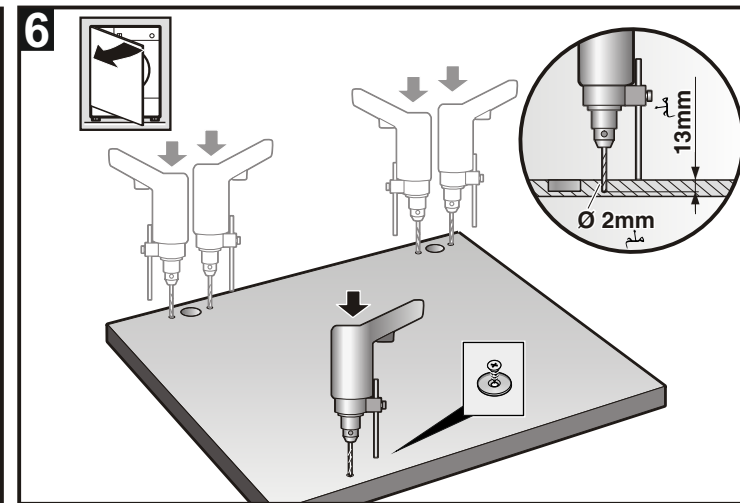
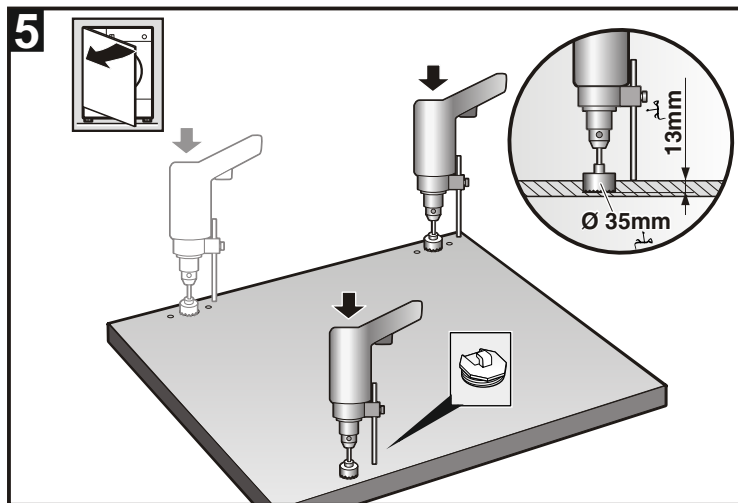
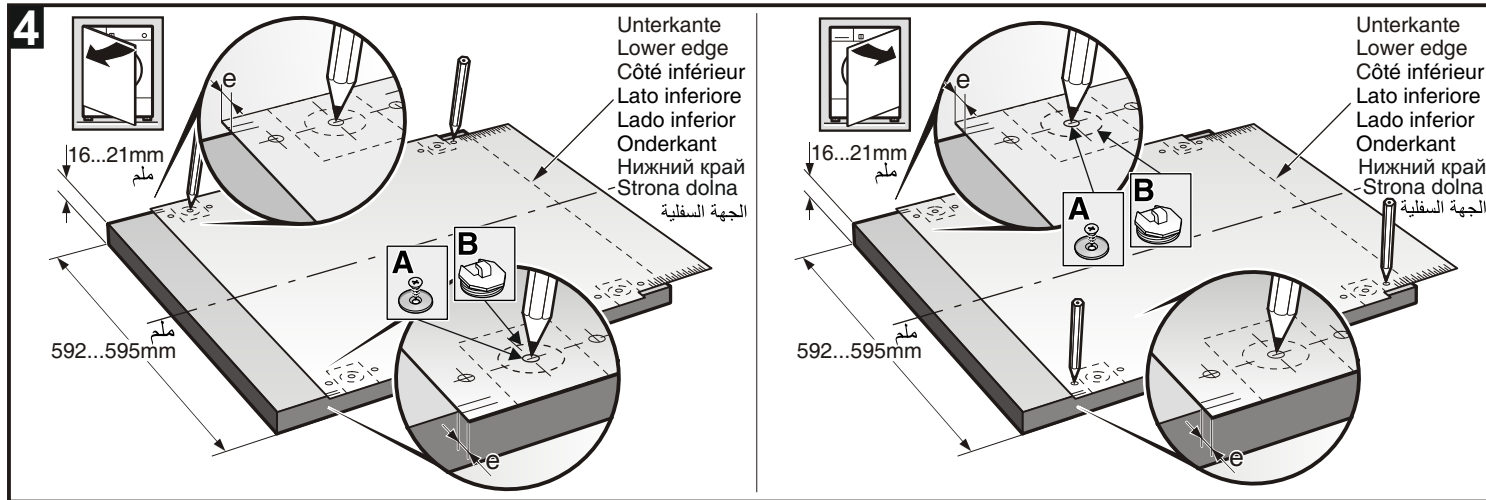

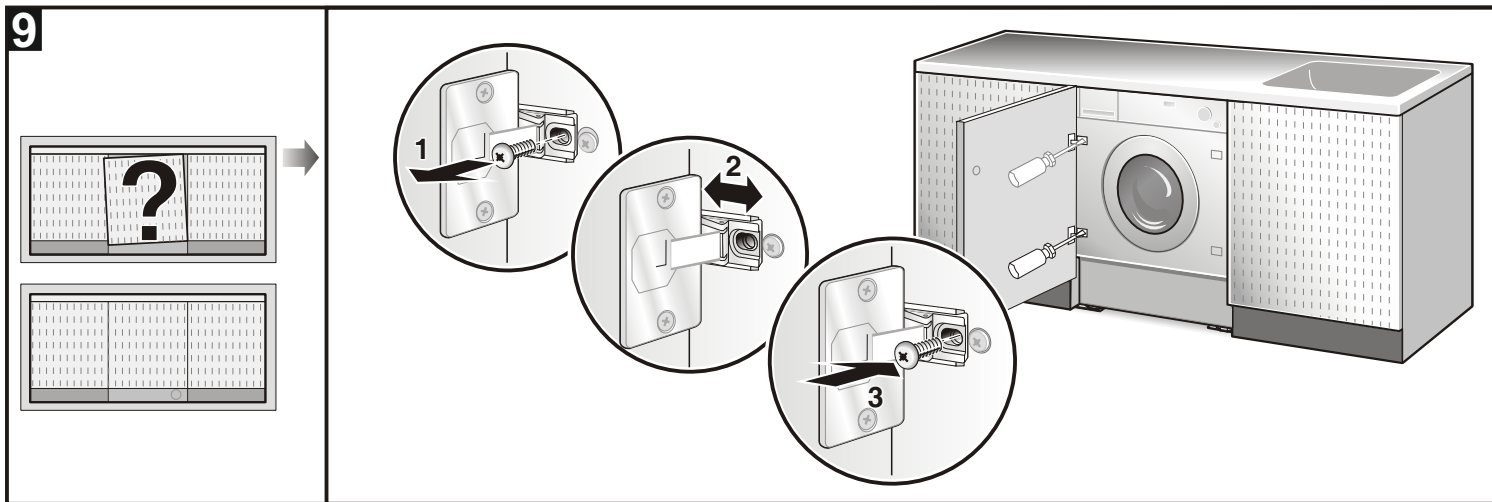
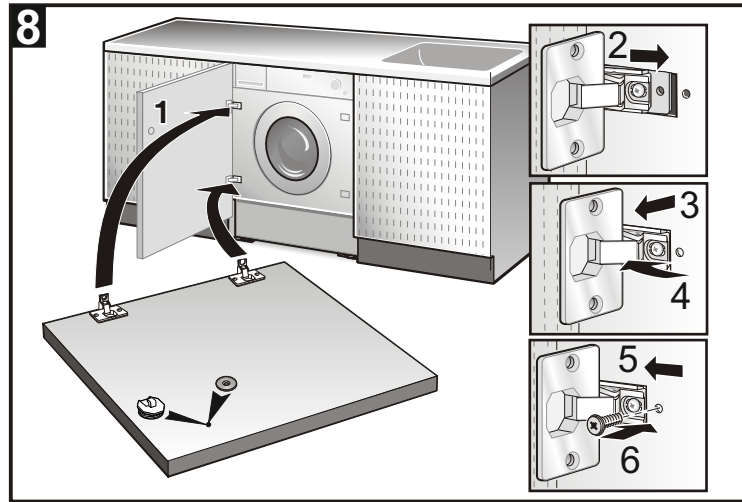

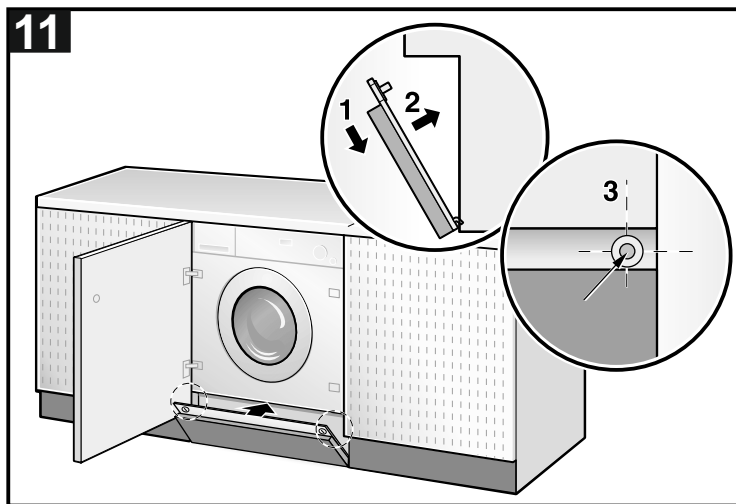
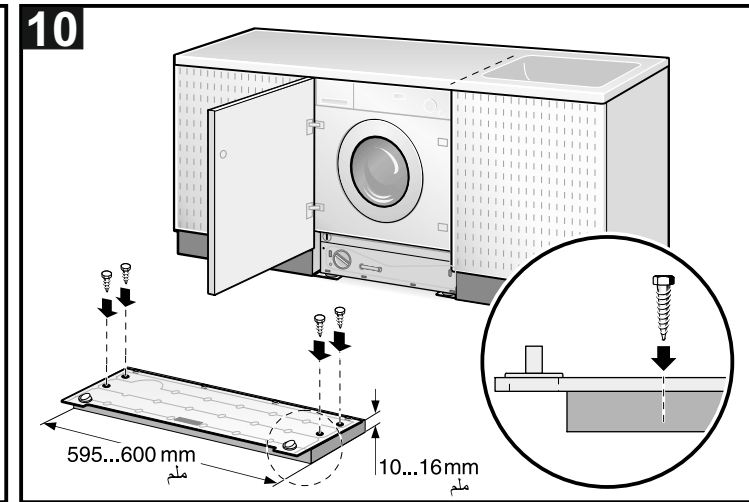
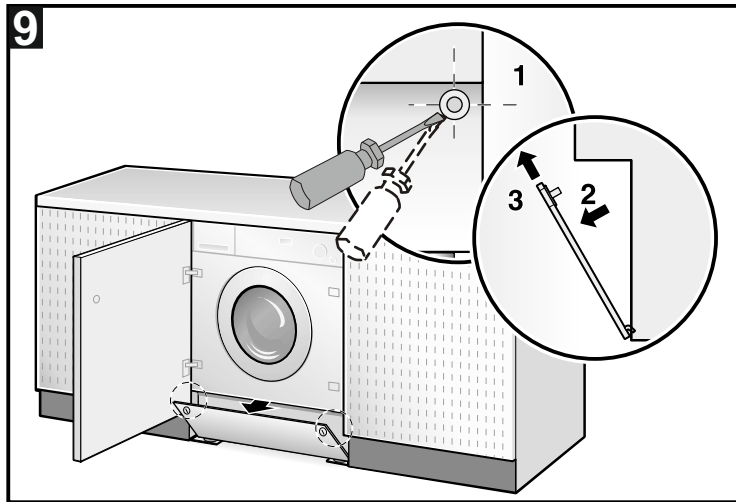



































































Programmi	Temp. (°C)	Max Centrifuga (giri/m')	Max. carico lavaggio (kg)	Scomparti cassetto detersivi			Opzioni					Descrizione programma lavaggio
				Prelavaggio	Lavaggio	Ammorbid.	Prelav.	Intensivo	Stira Meno	Risciacquo aggiuntivo	Rapido	
												
<b>Cotone e colorati</b> 	Delicati colorati poco sporchi	 / 20°	Max	7	✓	✓	✓	✓	✓	✓	✓	Lavaggio a freddo o 20°C, risciacqui e centrifuga finale alla velocità selezionata
	Delicati colorati normalmente sporchi	30° / 40°	Max	7	✓	✓	✓	✓	-	✓	✓	Lavaggio a 30° o 40°C, risciacqui e centrifuga finale alla velocità selezionata
	Colorati resistenti normalmente sporchi	60°	Max	7	✓	✓	✓	✓	-	✓	✓	Lavaggio a 60°C, risciacqui e centrifuga finale alla velocità selezionata
	Colorati resistenti molto sporchi	90°	Max	7	✓	✓	✓	✓	✓	✓	✓	Lavaggio a 90°C, risciacqui e centrifuga finale alla velocità selezionata
<b>Eco 40-60</b>	Capi in cotone normalmente sporchi lavabili insieme a 60 °C o 40 °C	-	Max	7	✓	✓	✓	✓	-	✓	✓	Lavaggio, risciacqui e centrifuga finale alla velocità selezionata
<b>Sintetici</b> 	Capi da rinfrescare	 / 20°	1000	3,5	✓	✓	✓	✓	-	✓	✓	Lavaggio a freddo o 20°C, risciacqui e centrifuga finale alla velocità selezionata
	Capi poco sporchi	30° / 40°	1000	3,5	✓	✓	✓	✓	-	✓	✓	Lavaggio a 30° o 40°C, risciacqui e centrifuga finale alla velocità selezionata
	Capi normalmente sporchi	60°	1000	3,5	✓	✓	✓	✓	-	✓	✓	Lavaggio a 60°C, risciacqui e centrifuga finale alla velocità selezionata
<b>Delicati / Seta</b> 	Capi da rinfrescare	 / 20°	600	2	-	✓	✓	-	✓	-	-	Lavaggio a freddo o 20°C, risciacqui e centrifuga finale alla velocità selezionata
	Capi poco sporchi	30° / 40°	600	2	-	✓	✓	-	✓	-	-	Lavaggio a 30° o 40°C, risciacqui e centrifuga finale alla velocità selezionata
<b>Lana</b> 	Capi da rinfrescare	 / 20°	800	2	-	✓	✓	-	-	-	-	Lavaggio freddo o 20°C, risciacqui e centrifuga finale alla velocità selezionata
	Capi poco sporchi	30° / 40°	800	2	-	✓	✓	-	-	-	-	Lavaggio a 30° o 40°C, risciacqui e centrifuga finale alla velocità selezionata
<b>Risciacquo e centrifuga</b> 	-	-	Max	7	-	-	✓	-	-	✓	-	Risciacquo e solo scarico, o scarico e centrifuga finale alla velocità selezionata
<b>Scarico e centrifuga</b> 	-	-	Max	7	-	-	-	-	✓	-	✓	Solo scarico, o scarico e centrifuga finale alla velocità selezionata
<b>Rapido</b> 	Cotone leggero o delicati da rinfrescare	 / 20° / 30°	800	2	-	✓	✓	-	-	-	-	Lavaggio a freddo 20°C / 30°C, risciacqui e centrifuga finale alla velocità selezionata
<b>Ciclo notturno</b> 	Capi molto delicati poco sporchi	 / 20°	1000	3	✓	✓	✓	✓	✓	-	✓	Lavaggio freddo o 20°C (avvisatore acustico disattivato), risciacqui e centrifuga finale alla velocità selezionata
	Capi poco sporchi	30° / 40°	1000	3	✓	✓	✓	✓	✓	-	✓	Lavaggio silenzioso a 30° / 40 °C (avvisatore acustico disattivato), risciacqui e centrifuga finale alla velocità selezionata
	Capi normalmente sporchi	60°	1000	3	✓	✓	✓	✓	✓	-	✓	Lavaggio silenzioso a 60 °C (avvisatore acustico disattivato), risciacqui e centrifuga finale alla velocità selezionata
<b>Ammorbidente</b> 	-	-	1000	3,5	-	-	✓	-	-	✓	-	Risciacquo e solo scarico, o scarico e centrifuga finale alla velocità selezionata
<b>Lava a mano</b> 	Capi da rinfrescare		-	2	-	✓	✓	-	-	-	-	Lavaggio freddo, risciacqui e centrifuga finale alla velocità selezionata
<b>Camicie / Lavoro</b> 	Capi da rinfrescare	 / 20°	800	2	-	✓	✓	-	✓	-	✓	Lavaggio freddo o 20°C, risciacqui e centrifuga finale alla velocità selezionata
	Capi poco sporchi	30° / 40°	800	2	-	✓	✓	-	✓	-	✓	Lavaggio a 30° o 40°C, risciacqui e centrifuga finale alla velocità selezionata
<b>Jeans</b> 	Capi da rinfrescare	 / 20°	800	2	-	✓	✓	-	✓	-	✓	Lavaggio freddo o 20°C, risciacqui e centrifuga finale alla velocità selezionata
	Capi poco sporchi	30° / 40°	800	2	-	✓	✓	-	✓	-	✓	Lavaggio a 30° o 40°C, risciacqui e centrifuga finale alla velocità selezionata
<b>Sport</b> 	Capi da rinfrescare	 / 20°	800	2	-	✓	✓	-	✓	-	✓	Lavaggio freddo o 20°C, risciacqui e centrifuga finale alla velocità selezionata
	Capi poco sporchi	30° / 40°	800	2	-	✓	✓	-	✓	-	✓	Lavaggio a 30° o 40°C, risciacqui e centrifuga finale alla velocità selezionata
<b>Misti</b> 	Cotone e sintetici da rinfrescare	 / 20°	Max	3	✓	✓	✓	✓	✓	✓	✓	Lavaggio freddo o 20°C, risciacqui e centrifuga finale alla velocità selezionata
	Cotone e sintetici poco sporchi	30° / 40°	Max	3	✓	✓	✓	✓	✓	✓	✓	Lavaggio a 30° o 40°C, risciacqui e centrifuga finale alla velocità selezionata

✓: Opzione disponibile



: Opzioni non selezionabili contemporaneamente

PROGRAM GUIDE

Programs		Temp. (°C)	Max. Spin (rpm)	Max. washing load (kg)	Detergent drawer compartments			Options					Wash program description	
					Prewash	Wash	Softner	Prewash	Intensive	Easy Iron	Extra rinse	Rapid		
														
<b>Cotton and coloureds</b>		Delicate coloureds with light dirt	 / 20°	Max	7	✓	✓	✓	✓	✓	✓	✓	Cold wash or 20°C, rinses and final spin at the selected speed	
		Delicate coloureds with normal dirt	30° / 40°	Max	7	✓	✓	✓	✓	-	✓	✓	✓	Wash at 30° or 40°C, rinses and final spin at the selected speed
		Tough coloureds with normal dirt	60°	Max	7	✓	✓	✓	✓	-	✓	✓	✓	Wash at 60°C, rinses and final spin at the selected speed
		Tough coloureds with heavy dirt	90°	Max	7	✓	✓	✓	✓	✓	✓	✓	✓	Wash at 90°C, rinses and final spin at the selected speed
<b>Eco 40-60</b>		Normally soiled cotton laundry declared washable at 60°C or 40°C together	-	Max	7	✓	✓	✓	✓	-	✓	✓	Wash, rinses and final spin at the selected speed	
<b>Synthetics</b>		Items for refreshing	 / 20°	1000	3,5	✓	✓	✓	✓	✓	-	✓	✓	Cold wash or 20°C, rinses and final spin at the selected speed
		Items with light dirt	30° / 40°	1000	3,5	✓	✓	✓	✓	✓	-	✓	✓	Wash at 30° or 40°C, rinses and final spin at the selected speed
		Items with normal dirt	60°	1000	3,5	✓	✓	✓	✓	✓	-	✓	✓	Wash at 60°C, rinses and final spin at the selected speed
<b>Delicate/Silk</b>		Items for refreshing	 / 20°	600	2	-	✓	✓	-	✓	-	✓	-	Cold wash or 20°C, rinses and final spin at the selected speed
		Items with light dirt	30° / 40°	600	2	-	✓	✓	-	✓	-	✓	-	Wash at 30° or 40°C, rinses and final spin at the selected speed
<b>Wool</b>		Items for refreshing	 / 20°	800	2	-	✓	✓	-	-	-	-	-	Cold wash or 20°C, rinses and final spin at the selected speed
		Items with light dirt	30° / 40°	800	2	-	✓	✓	-	-	-	-	-	-
<b>Rinse and spin</b>			-	Max	7	-	-	✓	-	-	✓	-	✓	Rinse and pump-out only, or pump-out and final spin at the selected speed
<b>Pump-out and spin</b>			-	Max	7	-	-	-	-	-	✓	-	✓	Pump-out only, or pump-out and final spin at the selected speed
<b>Rapid</b>		Light cotton or delicate fabrics for refreshing	 / 20° / 30°	800	2	-	✓	✓	-	-	-	-	-	Cold wash or 20°C / 30°C, rinses and final spin at the selected speed
<b>Night Wash</b>		Very delicates items with light dirt	 / 20°	1000	3	✓	✓	✓	✓	✓	-	✓	✓	Silent cold wash or 20°C (buzzer off), rinses and final spin at the selected speed
		Items with light dirt	30° / 40°	1000	3	✓	✓	✓	✓	✓	-	✓	✓	Silent wash at 30°/40°C (buzzer off), rinses and final spin at the selected speed
		Items with normal dirt	60°	1000	3	✓	✓	✓	✓	✓	-	✓	✓	Silent wash at 60°C (buzzer off), rinses and final spin at the selected speed
<b>Softner</b>			-	1000	3,5	-	-	✓	-	-	✓	-	-	Rinse and pump-out only, or pump-out and final spin at the selected speed
<b>Hand wash</b>		Items for refreshing		800	2	-	✓	✓	-	-	-	-	-	Cold wash, rinses and final spin at the selected speed
<b>Shirt/Work</b>		Items for refreshing	 / 20°	800	2	-	✓	✓	-	✓	-	✓	✓	Cold wash or 20°C, rinses and final spin at the selected speed
		Items with light dirt	30° / 40°	800	2	-	✓	✓	-	✓	-	✓	✓	Wash at 30° or 40°C, rinses and final spin at the selected speed
<b>Jeans</b>		Items for refreshing	 / 20°	800	2	-	✓	✓	-	✓	-	✓	✓	Cold wash or 20°C, rinses and final spin at the selected speed
		Items with light dirt	30° / 40°	800	2	-	✓	✓	-	✓	-	✓	✓	Wash at 30° or 40°C, rinses and final spin at the selected speed
<b>Sport</b>		Items for refreshing	 / 20°	800	2	-	✓	✓	-	✓	-	✓	✓	Cold wash or 20°C, rinses and final spin at the selected speed
		Items with light dirt	30° / 40°	800	2	-	✓	✓	-	✓	-	✓	✓	Wash at 30° or 40°C, rinses and final spin at the selected speed
<b>Mixed</b>		Cotton and synthetics for refreshing	 / 20°	Max	3	✓	✓	✓	✓	✓	✓	✓	✓	Cold wash or 20°C, rinses and final spin at the selected speed
		Cotton and synthetics with light dirt	30° / 40°	Max	3	✓	✓	✓	✓	✓	✓	✓	✓	✓

✓: Option available



: Options which cannot be selected simultaneously

































Programmes	Temp. (°C)	Max Essorage (trs/mn)	Charge maxi. lavage (kg)	Compartiments bac à détergents			Options					Description programme de lavage
				Pré-lavage	Lavage	Adoucissant	Pré-lavage	Intensif	Anti-froissement	Rinçage plus	Rapide	
<b>Coton et couleurs</b> 	Linge de couleur délicat peu sale	/ 20°	Max	7	✓	✓	✓	✓	✓	✓	✓	Lavage à froid ou 20°C, rinçages et essorage final à la vitesse sélectionnée
	Linge de couleur délicat normalement sale	30° / 40°	Max	7	✓	✓	✓	✓	-	✓	✓	Lavage à 30° ou 40°C, rinçages et essorage final à la vitesse sélectionnée
	Linge de couleur résistant normalement sale	60°	Max	7	✓	✓	✓	✓	-	✓	✓	Lavage à 60°C, rinçages et essorage final à la vitesse sélectionnée
	Linge de couleur résistant très sale	90°	Max	7	✓	✓	✓	✓	✓	✓	✓	Lavage à 90°C, rinçages et essorage final à la vitesse sélectionnée
<b>Eco 40-60</b>	Linge en coton normalement sale déclaré lavable à 60°C ou à 40°C ensemble	-	Max	7	✓	✓	✓	✓	-	✓	✓	Lavage, rinçages et essorage final à la vitesse sélectionnée
<b>Synthétiques</b> 	Vêtements à rafraîchir	/ 20°	1000	3,5	✓	✓	✓	✓	-	✓	✓	Lavage à froid ou 20°C, rinçages et essorage final à la vitesse sélectionnée
	Vêtements peu sales	30° / 40°	1000	3,5	✓	✓	✓	✓	-	✓	✓	Lavage à 30° ou 40°C, rinçages et essorage final à la vitesse sélectionnée
	Vêtements normalement sales	60°	1000	3,5	✓	✓	✓	✓	-	✓	✓	Lavage à 60°C, rinçages et essorage final à la vitesse sélectionnée
<b>Déliçats/Soie</b> 	Vêtements à rafraîchir	/ 20°	600	2	-	✓	✓	-	✓	-	-	Lavage à froid ou 20°C, rinçages et essorage final à la vitesse sélectionnée
	Vêtements peu sales	30° / 40°	600	2	-	✓	✓	-	✓	-	-	Lavage à 30° ou 40°C, rinçages et essorage final à la vitesse sélectionnée
<b>Laine</b> 	Vêtements à rafraîchir	/ 20°	800	2	-	✓	✓	-	-	-	-	Lavage à froid ou 20°C, rinçages et essorage final à la vitesse sélectionnée
	Vêtements peu sales	30° / 40°	800	2	-	✓	✓	-	-	-	-	Lavage à 30° ou 40°C, rinçages et essorage final à la vitesse sélectionnée
<b>Rinçage et essorage</b> 		-	Max	7	-	-	✓	-	-	✓	-	Rinçage et vidange uniquement, ou vidange et essorage final à la vitesse sélectionnée
<b>Vidange et essorage</b> 		-	Max	7	-	-	-	-	-	✓	-	Vidange uniquement, ou vidange et essorage final à la vitesse sélectionnée
<b>Rapide</b> 	Coton léger ou tissus délicats à rafraîchir	/ 20° / 30°	800	2	-	✓	✓	-	-	-	-	Lavage à froid ou 20°C / 30°C, rinçages et essorage final à la vitesse sélectionnée
<b>Purge nocturne</b> 	Vêtements à rafraîchir	/ 20°	1000	3	✓	✓	✓	✓	✓	-	✓	Lavage calme à froid ou 20°C (cor off), rinçages et essorage final à la vitesse sélectionnée
	Vêtements peu sales	30° / 40°	1000	3	✓	✓	✓	✓	✓	-	✓	Lavage calme à 30° / 40°C (cor off), rinçages et essorage final à la vitesse sélectionnée
	Vêtements normalement sales	60°	1000	3	✓	✓	✓	✓	✓	-	✓	Lavage calme à 60°C (cor off), rinçages et essorage final à la vitesse sélectionnée
<b>Adoucissant</b> 		-	1000	3,5	-	-	✓	-	-	✓	-	Rinçage et vidange uniquement, ou vidange et essorage final à la vitesse sélectionnée
<b>Lavage à la main</b> 	Vêtements à rafraîchir		800	2	-	✓	✓	-	-	-	-	Lavage à froid, rinçages et essorage final à la vitesse sélectionnée
<b>Chemises / Travail</b> 	Vêtements à rafraîchir	/ 20°	800	2	-	✓	✓	-	✓	-	✓	Lavage à froid ou 20°C, rinçages et essorage final à la vitesse sélectionnée
	Vêtements peu sales	30° / 40°	800	2	-	✓	✓	-	✓	-	✓	Lavage à 30° ou 40°C, rinçages et essorage final à la vitesse sélectionnée
<b>Jeans</b> 	Vêtements à rafraîchir	/ 20°	800	2	-	✓	✓	-	✓	-	✓	Lavage à froid ou 20°C, rinçages et essorage final à la vitesse sélectionnée
	Vêtements peu sales	30° / 40°	800	2	-	✓	✓	-	✓	-	✓	Lavage à 30° ou 40°C, rinçages et essorage final à la vitesse sélectionnée
<b>Sport</b> 	Vêtements à rafraîchir	/ 20°	800	2	-	✓	✓	-	✓	-	✓	Lavage à froid ou 20°C, rinçages et essorage final à la vitesse sélectionnée
	Vêtements peu sales	30° / 40°	800	2	-	✓	✓	-	✓	-	✓	Lavage à 30° ou 40°C, rinçages et essorage final à la vitesse sélectionnée
<b>Tissus mixtes</b> 	Coton et synthétiques à rafraîchir	/ 20°	Max	3	✓	✓	✓	✓	✓	✓	✓	Lavage à froid ou 20°C, rinçages et essorage final à la vitesse sélectionnée
	Coton et synthétiques peu sales	30° / 40°	Max	3	✓	✓	✓	✓	✓	✓	✓	Lavage à 30° ou 40°C, rinçages et essorage final à la vitesse sélectionnée

✓ : Option disponible



: Options non sélectionnables simultanément

PROGRAMM-LEITFADEN

Programme		Temp. (°C)	Max. Schleuderdrehzahl (U/min)	Max. Beladung Waschen (kg)	Kammern der Waschmittelschublade			Optionen					Beschreibung des Waschprogramms		
					Vorwäsche	Hauptwäsche	Weichspüler	Vorwäsche	Intensiv	Bügelleicht	Sonder-spülgang	Schnell			
															
<b>Baumwoll- und Buntwäsche</b>		Gering verschmutzte nicht farbechte Buntwäsche	 / 20°	Max.	7	✓	✓	✓	✓	✓	✓	✓	Kaltwäsche oder 20°C, Spülen und Endschleudern mit der eingestellten Drehzahl		
		Normal verschmutzte nicht farbechte Buntwäsche	30° / 40°	Max.	7	✓	✓	✓	-	✓	✓	✓	Hauptwäsche 30°C oder 40°C, Spülen und Endschleudern mit der eingestellten Drehzahl		
		Normal verschmutzte farbechte Buntwäsche	60°	Max.	7	✓	✓	✓	-	✓	✓	✓	Hauptwäsche 60°C, Spülen und Endschleudern mit der eingestellten Drehzahl		
		Stark verschmutzte farbechte Buntwäsche	90°	Max.	7	✓	✓	✓	✓	✓	✓	✓	Hauptwäsche 90°C, Spülen und Endschleudern mit der eingestellten Drehzahl		
<b>Eco 40-60</b>		Linge en coton normalement sale déclaré lavable à 60°C ou à 40°C ensemble	-	Max.	7	✓	✓	✓	-	✓	✓	✓	Lavage, rinçages et essorage final à la vitesse sélectionnée		
<b>Synthetik</b>		Wäsche, die aufgefrischt werden soll	 / 20°	1000	3,5	✓	✓	✓	✓	-	✓	✓	Kaltwäsche oder 20°C, Spülen und Endschleudern mit der eingestellten Drehzahl		
		Gering verschmutzte Wäsche	30° / 40°	1000	3,5	✓	✓	✓	✓	-	✓	✓	Hauptwäsche 30°C oder 40°C, Spülen und Endschleudern mit der eingestellten Drehzahl		
		Normal verschmutzte Wäsche	60°	1000	3,5	✓	✓	✓	✓	-	✓	✓	Hauptwäsche 60°C, Spülen und Endschleudern mit der eingestellten Drehzahl		
<b>Empfindliche Wäsche/Seide</b>		Wäsche, die aufgefrischt werden soll	 / 20°	600	2	-	✓	✓	✓	-	✓	-	Kaltwäsche oder 20°C, Spülen und Endschleudern mit der eingestellten Drehzahl		
		Gering verschmutzte Wäsche	30° / 40°	600	2	-	✓	✓	✓	-	✓	-	Hauptwäsche 30°C oder 40°C, Spülen und Endschleudern mit der eingestellten Drehzahl		
<b>Wolle</b>		Wäsche, die aufgefrischt werden soll	 / 20°	800	2	-	✓	✓	-	-	-	-	Kaltwäsche oder 20°C, Spülen und Endschleudern mit der eingestellten Drehzahl		
		Gering verschmutzte Wäsche	30° / 40°	800	2	-	✓	✓	-	-	-	-	Hauptwäsche 30°C oder 40°C, Spülen und Endschleudern mit der eingestellten Drehzahl		
<b>Spülen und Schleudern</b>						-	Max.	7	-	-	✓	-	✓	Spülen und nur Abpumpen oder Abpumpen und Endschleudern mit der eingestellten Drehzahl	
<b>Abpumpen und Schleudern</b>						-	Max.	7	-	-	✓	-	✓	Nur Abpumpen oder Abpumpen und Endschleudern mit der eingestellten Drehzahl	
<b>Schnell</b>		Leichte Baumwollstoffe oder empfindliche Textilien, die aufgefrischt werden sollen	 / 20° / 30°	800	2	-	✓	✓	-	-	-	-	Kaltwäsche oder Hauptwäsche → 20° C / 30°C, Spülen und Endschleudern mit der eingestellten Drehzahl		
<b>Nachtbetrieb</b>		Gering verschmutzte sehr empfindliche Wäsche	 / 20°	1000	3	✓	✓	✓	✓	✓	-	✓	Leiser Kaltwaschgang oder Hauptwaschgang → 20°C (Summer AUS), Spülen und Endschleudern mit der eingestellten Drehzahl		
		Gering verschmutzte Wäsche	30° / 40°	1000	3	✓	✓	✓	✓	✓	✓	-	✓	Leiser Hauptwaschgang 30° / 40°C (Summer AUS), Spülen und Endschleudern mit der eingestellten Drehzahl	
		Normal verschmutzte Wäsche	60°	1000	3	✓	✓	✓	✓	✓	✓	-	✓	Leiser Hauptwaschgang 60°C (Summer AUS), Spülen und Endschleudern mit der eingestellten Drehzahl	
<b>Weichspüler</b>			-	1000	3,5	-	-	✓	-	-	✓	-	Spülen und nur Abpumpen oder Abpumpen und Endschleudern mit der eingestellten Drehzahl		
<b>Handwäsche</b>		Wäsche, die aufgefrischt werden soll		800	2	-	✓	✓	-	-	-	-	Kaltwäsche, Spülen und Endschleudern mit der eingestellten Drehzahl		
<b>Hemden / Arbeitskleidung</b>		Wäsche, die aufgefrischt werden soll	 / 20°	800	2	-	✓	✓	-	✓	-	✓	Kaltwäsche oder 20°C, Spülen und Endschleudern mit der eingestellten Drehzahl		
		Gering verschmutzte Wäsche	30° / 40°	800	2	-	✓	✓	-	✓	-	✓	Hauptwäsche 30°C oder 40°C, Spülen und Endschleudern mit der eingestellten Drehzahl		
<b>Jeans</b>		Wäsche, die aufgefrischt werden soll	 / 20°	800	2	-	✓	✓	-	✓	-	✓	Kaltwäsche oder 20°C, Spülen und Endschleudern mit der eingestellten Drehzahl		
		Gering verschmutzte Wäsche	30° / 40°	800	2	-	✓	✓	-	✓	-	✓	Hauptwäsche 30°C oder 40°C, Spülen und Endschleudern mit der eingestellten Drehzahl		
<b>Sport</b>		Wäsche, die aufgefrischt werden soll	 / 20°	800	2	-	✓	✓	-	✓	-	✓	Kaltwäsche oder 20°C, Spülen und Endschleudern mit der eingestellten Drehzahl		
		Gering verschmutzte Wäsche	30° / 40°	800	2	-	✓	✓	-	✓	-	✓	Hauptwäsche 30°C oder 40°C, Spülen und Endschleudern mit der eingestellten Drehzahl		
<b>Gemischte Wäsche</b>		Baumwolle und Synthetik, die aufgefrischt werden soll	 / 20°	Max.	3	✓	✓	✓	✓	✓	✓	✓	Kaltwäsche oder 20°C, Spülen und Endschleudern mit der eingestellten Drehzahl		
		Gering verschmutzte Baumwolle und Synthetik	30° / 40°	Max.	3	✓	✓	✓	✓	✓	✓	✓	✓	Hauptwäsche 30°C oder 40°C, Spülen und Endschleudern mit der eingestellten Drehzahl	

✓: Option verfügbar



: Diese Optionen können nicht gleichzeitig gewählt werden.

Programas	Temp. (°C)	Máx. Centrifuga (r.p.m.)	Carga máx. lavado (kg)	Compartimentos cajón detergentes			Opciones					Descripción programa lavado	
				Prelavado	Lavado	Suavizante	Prelavado	Intensivo	Planchar menos	Enjuague adicional	Rápido		
<b>Algodón y coloreados</b> 	Delicadas coloreadas poco sucias	/ 20°	Máx.	7	✓	✓	✓	✓	✓	✓	✓	Lavado en frío ou de 20°C, enjuagues y centrifugado final a la velocidad seleccionada	
	Delicadas coloreadas normalmente sucias	30° / 40°	Máx.	7	✓	✓	✓	✓	-	✓	✓	Lavado a 30° / 40 °C, enjuagues y centrifugado final a la velocidad seleccionada	
	Coloreadas resistentes normalmente sucias	60°	Máx.	7	✓	✓	✓	✓	-	✓	✓	Lavado a 60 °C, enjuagues y centrifugado final a la velocidad seleccionada	
	Coloreadas resistentes muy sucias	90°	Máx.	7	✓	✓	✓	✓	✓	✓	✓	Lavado a 90 °C, enjuagues y centrifugado final a la velocidad seleccionada	
<b>Eco 40-60</b>	Roupas de algodão com sujidade normal que podem ser lavadas juntas a 60 °C ou 40 °C	-	Máx.	7	✓	✓	✓	✓	-	✓	✓	Lavagem, enxaguamentos e centrifugação final na velocidade seleccionada	
<b>Sintéticas</b> 	Prendas a refrescar	/ 20°	1000	3,5	✓	✓	✓	✓	✓	-	✓	Lavado en frío ou de 20°C, enjuagues y centrifugado final a la velocidad seleccionada	
	Prendas poco sucias	30° / 40°	1000	3,5	✓	✓	✓	✓	✓	-	✓	Lavado a 30 ° ou de 40°C, enjuagues y centrifugado final a la velocidad seleccionada	
	Prendas normalmente sucias	60°	1000	3,5	✓	✓	✓	✓	✓	-	✓	Lavado a 60 °C, enjuagues y centrifugado final a la velocidad seleccionada	
<b>Delicadas/Seda</b> 	Prendas a refrescar	/ 20°	600	2	-	✓	✓	-	✓	-	-	Lavado en frío ou de 20°C, enjuagues y centrifugado final a la velocidad seleccionada	
	Prendas poco sucias	30° / 40°	600	2	-	✓	✓	-	✓	-	-	Lavado a 30 ° ou de 40°C, enjuagues y centrifugado final a la velocidad seleccionada	
<b>Lana</b> 	Prendas a refrescar	/ 20°	800	2	-	✓	✓	-	-	-	-	Lavado en frío ou de 20°C, enjuagues y centrifugado final a la velocidad seleccionada	
	Prendas poco sucias	30° / 40°	800	2	-	✓	✓	-	-	-	-	Lavado a 30 ° ou de 40°C, enjuagues y centrifugado final a la velocidad seleccionada	
<b>Enjuague y centrifugado</b> 	-	Máx.	7	-	-	✓	-	-	✓	-	✓	Enjuague y sólo descarga o descarga y centrifugado final a la velocidad seleccionada	
<b>Descarga y centrifugado</b> 	-	Máx.	7	-	-	-	-	-	✓	-	✓	Sólo descarga o descarga y centrifugado final a la velocidad seleccionada	
<b>Rápido</b> 	Algodón ligero o delicadas a refrescar	/20°/ 30°	800	2	-	✓	✓	-	-	-	-	Lavado en frío ou de 20°C/ 30°C , enjuagues y centrifugado final a la velocidad seleccionada	
<b>Noche de purga</b> 	Prendas a refrescar	/ 20°	1000	3	✓	✓	✓	✓	✓	✓	-	✓	Lavado tranquilo en frío → 20° (cuerno off), enjuagues y centrifugado final a la velocidad seleccionada
	Prendas poco sucias	30° / 40°	1000	3	✓	✓	✓	✓	✓	✓	-	✓	Lavado tranquilo a 30° C / 40 °C (cuerno off), enjuagues y centrifugado final a la velocidad seleccionada
	Prendas normalmente sucias	60°	1000	3	✓	✓	✓	✓	✓	✓	-	✓	Lavado tranquilo a 60 °C (cuerno off), enjuagues y centrifugado final a la velocidad seleccionada
<b>Suavizante</b> 	-	1000	3,5	-	-	✓	-	-	✓	-	-	Enjuague y sólo descarga o descarga y centrifugado final a la velocidad seleccionada	
<b>Lavar a mano</b> 	Prendas a refrescar		800	2	-	✓	✓	-	-	-	-	Lavado en frío, enjuagues y centrifugado final a la velocidad seleccionada	
<b>Camisas / Trabajo</b> 	Prendas a refrescar	/ 20°	800	2	-	✓	✓	-	✓	-	✓	Lavado en frío ou de 20°C, enjuagues y centrifugado final a la velocidad seleccionada	
	Prendas poco sucias	30° / 40°	800	2	-	✓	✓	-	✓	-	✓	Lavado a 30 ° ou de 40°C, enjuagues y centrifugado final a la velocidad seleccionada	
<b>Jeans</b> 	Prendas a refrescar	/ 20°	800	2	-	✓	✓	-	✓	-	✓	Lavado en frío ou de 20°C, enjuagues y centrifugado final a la velocidad seleccionada	
	Prendas poco sucias	30° / 40°	800	2	-	✓	✓	-	✓	-	✓	Lavado a 30 ° ou de 40°C, enjuagues y centrifugado final a la velocidad seleccionada	
<b>Sport</b> 	Prendas a refrescar	/ 20°	800	2	-	✓	✓	-	✓	-	✓	Lavado en frío ou de 20°C, enjuagues y centrifugado final a la velocidad seleccionada	
	Prendas poco sucias	30° / 40°	800	2	-	✓	✓	-	✓	-	✓	Lavado a 30 ° ou de 40°C, enjuagues y centrifugado final a la velocidad seleccionada	
<b>Mixtas</b> 	Algodón y sintéticas a refrescar	/ 20°	Máx.	3	✓	✓	✓	✓	✓	✓	✓	Lavado en frío ou de 20°C, enjuagues y centrifugado final a la velocidad seleccionada	
	Algodón y sintéticas poco sucias	30° / 40°	Máx.	3	✓	✓	✓	✓	✓	✓	✓	Lavado a 30 ° ou de 40°C, enjuagues y centrifugado final a la velocidad seleccionada	

✓ Opción disponible



: Opciones no seleccionables simultáneamente



## LEIDRAAD PROGRAMMA'S

Programma's	Temp. (°C)	Max. Centrifuge (toeren/min.)	Max. vulgewicht (kg)	Vakjes wasmiddellade			Opties					Beschrijving wasprogramma	
				Voorwas	Hoofdwash	Wasverzachter	Voorwas	Intensief	Minder strijken	Extra spoelbeurt	Snel		
<b>Katoen en bonte was</b>	Delicate, bonte, weinig vieze was	/ 20°	Max	7	✓	✓	✓	✓	✓	✓	✓	✓	Koud wassen of 20°C, spoelen en eindcentrifuge bij geselecteerde snelheid
	Delicate bonte, normaal vieze was	30° / 40°	Max	7	✓	✓	✓	✓	-	✓	✓	✓	Wassen op 30° of 40°C, spoelen en eindcentrifuge bij geselecteerde snelheid
	Kleurvaste bonte, normaal vieze was	60°	Max	7	✓	✓	✓	✓	-	✓	✓	✓	Wassen op 60°C, spoelen en eindcentrifuge bij geselecteerde snelheid
	Kleurvaste bonte, bijzonder vieze was	90°	Max	7	✓	✓	✓	✓	✓	✓	✓	✓	Wassen op 90°C, spoelen en eindcentrifuge bij geselecteerde snelheid
<b>Eco 40-60</b>	Katoenen was, normaal vervuild wasbaar op 60°C of 40°C samen	-	Máx.	7	✓	✓	✓	✓	-	✓	✓	✓	Wassen, spoelen en centrifugeren op het geselecteerde toerental
<b>Synthetische was</b>	Op te frissen was	/ 20°	1000	3,5	✓	✓	✓	✓	✓	-	✓	✓	Koud wassen of 20°C, spoelen en eindcentrifuge bij geselecteerde snelheid
	Weinig vieze was	30° / 40°	1000	3,5	✓	✓	✓	✓	✓	-	✓	✓	Wassen op 30° of 40°C, spoelen en eindcentrifuge bij geselecteerde snelheid
	Normaal vieze was	60°	1000	3,5	✓	✓	✓	✓	✓	-	✓	✓	Wassen op 60°C, spoelen en eindcentrifuge bij geselecteerde snelheid
<b>Delicate was / zijde</b>	Op te frissen was	/ 20°	600	2	-	✓	✓	-	✓	-	✓	-	Koud wassen of 20°C, spoelen en eindcentrifuge bij geselecteerde snelheid
	Weinig vieze was	30° / 40°	600	2	-	✓	✓	-	✓	-	✓	-	Wassen op 30° of 40°C, spoelen en eindcentrifuge bij geselecteerde snelheid
<b>Wol</b>	Op te frissen was	/ 20°	800	2	-	✓	✓	-	-	-	-	-	Koud wassen of 20°C, spoelen en eindcentrifuge bij geselecteerde snelheid
	Weinig vieze was	30° / 40°	800	2	-	✓	✓	-	-	-	-	-	Wassen op 30° of 40°C, spoelen en eindcentrifuge bij geselecteerde snelheid
<b>Spoelen en centrifugeren</b>	+	-	Max	7	-	-	✓	-	-	✓	-	✓	Spoelen en alleen leegpompen, of leegpompen en eindcentrifuge bij geselecteerde snelheid
<b>Leegpompen en centrifugeren</b>	+	-	Max	7	-	-	-	-	-	✓	-	✓	Alleen leegpompen, of leegpompen en eindcentrifuge bij geselecteerde snelheid
<b>Snel</b>	Op te frissen lichte katoenen of delicate was	/ 20° / 30°	800	2	-	✓	✓	-	-	-	-	-	Koud of → 20°C / 30°C wassen, spoelen en eindcentrifuge bij geselecteerde snelheid
<b>Nachtwas</b>	Bijzonder delicate, weinig vieze was	/ 20°	1000	3	✓	✓	✓	✓	✓	✓	-	✓	Stil wassen, koud of → 20°C (zoemer uit), spoelen en eindcentrifuge bij geselecteerde snelheid
	Weinig vieze was	30° / 40°	1000	3	✓	✓	✓	✓	✓	✓	-	✓	Stil wassen op 30° C / 40°C (zoemer uit), spoelen en eindcentrifuge bij geselecteerde snelheid
	Normaal vieze was	60°	1000	3	✓	✓	✓	✓	✓	✓	-	✓	Stil wassen op 60°C (zoemer uit), spoelen en eindcentrifuge bij geselecteerde snelheid
<b>Wasverzachter</b>		-	1000	3,5	-	-	✓	-	-	✓	-	-	Spoelen en alleen leegpompen, of leegpompen en eindcentrifuge bij geselecteerde snelheid
<b>Handwas</b>	Op te frissen was		800	2	-	✓	✓	-	-	-	-	-	Koud wassen, spoelen en eindcentrifuge bij geselecteerde snelheid
<b>Overhemden / Werk</b>	Op te frissen was	/ 20°	800	2	-	✓	✓	-	✓	-	✓	✓	Koud wassen of 20°C, spoelen en eindcentrifuge bij geselecteerde snelheid
	Weinig vieze was	30° / 40°	800	2	-	✓	✓	-	✓	-	✓	✓	Wassen op 30° of 40°C, spoelen en eindcentrifuge bij geselecteerde snelheid
<b>Jeans</b>	Op te frissen was	/ 20°	800	2	-	✓	✓	-	✓	-	✓	✓	Koud wassen of 20°C, spoelen en eindcentrifuge bij geselecteerde snelheid
	Weinig vieze was	30° / 40°	800	2	-	✓	✓	-	✓	-	✓	✓	Wassen op 30° of 40°C, spoelen en eindcentrifuge bij geselecteerde snelheid
<b>Sport</b>	Op te frissen was	/ 20°	800	2	-	✓	✓	-	✓	-	✓	✓	Koud wassen of 20°C, spoelen en eindcentrifuge bij geselecteerde snelheid
	Weinig vieze was	30° / 40°	800	2	-	✓	✓	-	✓	-	✓	✓	Wassen op 30° of 40°C, spoelen en eindcentrifuge bij geselecteerde snelheid
<b>Gemengd</b>	Op te frissen katoenen en synthetische was	/ 20°	Max	3	✓	✓	✓	✓	✓	✓	✓	✓	Koud wassen of 20°C, spoelen en eindcentrifuge bij geselecteerde snelheid
	Weinig vieze katoenen en synthetische was	30° / 40°	Max	3	✓	✓	✓	✓	✓	✓	✓	✓	Wassen op 30° of 40°C, spoelen en eindcentrifuge bij geselecteerde snelheid

✓: Beschikbare optie



: niet gelijktijdig selecteerbare opties

Programas	Temp. (°C)	Centrifugação máx. (rpm)	Carga máx. de lavagem (kg)	Compartimentos da gaveta para detergentes			Opções					Descrição do programa de lavagem
				Pré-lavagem	Lavagem	Amaciador	Pré-lavagem	Intensiva	Engomar fácil	Enxaguamento adicional	Rápida	
<b>Roupas de algodão e</b> 	Roupas delicadas coloridas pouco sujas	/ 20°	Máx.	7	✓	✓	✓	✓	✓	✓	✓	Lavagem com água fria ou a 20°C, enxaguamentos e centrifugação final à velocidade seleccionada
	Roupas delicadas coloridas normalmente sujas	30° / 40°	Máx.	7	✓	✓	✓	✓	-	✓	✓	Lavagem a 30° ou a 40°C, enxaguamentos e centrifugação final à velocidade seleccionada
	Roupas coloridas resistentes normalmente sujas	60°	Máx.	7	✓	✓	✓	✓	-	✓	✓	Lavagem a 60°C, enxaguamentos e centrifugação final à velocidade seleccionada
	Roupas coloridas resistentes muito sujas	90°	Máx.	7	✓	✓	✓	✓	✓	✓	✓	Lavagem a 90°C, enxaguamentos e centrifugação final à velocidade seleccionada
<b>Eco 40-60</b>	Roupas de algodão com sujidade normal que podem ser lavadas juntas a 60 °C ou 40 °C	-	Máx.	7	✓	✓	✓	✓	-	✓	✓	Lavagem, enxaguamentos e centrifugação final na velocidade seleccionada
<b>Roupas sintéticas</b> 	Roupas a refrescar	/ 20°	1000	3,5	✓	✓	✓	✓	-	✓	✓	Lavagem com água fria ou a 20°C, enxaguamentos e centrifugação final à velocidade seleccionada
	Roupas pouco sujas	30° / 40°	1000	3,5	✓	✓	✓	✓	-	✓	✓	Lavagem a 30° ou a 40°C, enxaguamentos e centrifugação final à velocidade seleccionada
	Roupas normalmente sujas	60°	1000	3,5	✓	✓	✓	✓	-	✓	✓	Lavagem a 60°C, enxaguamentos e centrifugação final à velocidade seleccionada
<b>Roupas delicadas/Silk</b> 	Roupas a refrescar	/ 20°	600	2	-	✓	✓	-	✓	-	-	Lavagem com água fria ou a 20°C, enxaguamentos e centrifugação final à velocidade seleccionada
	Roupas pouco sujas	30° / 40°	600	2	-	✓	✓	-	✓	-	-	Lavagem a 30° ou a 40°C, enxaguamentos e centrifugação final à velocidade seleccionada
<b>Lã</b> 	Roupas a refrescar	/ 20°	800	2	-	✓	✓	-	-	-	-	Lavagem com água fria ou a 20°C, enxaguamentos e centrifugação final à velocidade seleccionada
	Roupas pouco sujas	30° / 40°	800	2	-	✓	✓	-	-	-	-	Lavagem a 30° ou a 40°C, enxaguamentos e centrifugação final à velocidade seleccionada
<b>Enxaguamento e centrifugação</b>		-	Máx.	7	-	-	✓	-	✓	-	✓	Enxaguamento e apenas descarga, ou descarga e centrifugação final à velocidade seleccionada
<b>Descarga e centrifugação</b>		-	Máx.	7	-	-	-	-	✓	-	✓	Apenas descarga ou descarga e centrifugação final à velocidade seleccionada
<b>Rápida</b> 	Roupas de algodão leve ou delicadas a refrescar	/ 20° / 30°	800	2	-	✓	✓	-	-	-	-	Lavagem com água fria → 20° / 30°C, enxaguamentos e centrifugação final à velocidade seleccionada
<b>Noite expurgo</b> 	Roupas a refrescar	/ 20°	1000	3	✓	✓	✓	✓	✓	-	✓	Lavagem sossegado com água fria → 20°C (buzina off), enxaguamentos e centrifugação final à velocidade seleccionada
	Roupas pouco sujas	30° / 40°	1000	3	✓	✓	✓	✓	✓	-	✓	Lavagem sossegado a 30° / 40°C (buzina off), enxaguamentos e centrifugação final à velocidade seleccionada
	Roupas normalmente sujas	60°	1000	3	✓	✓	✓	✓	✓	-	✓	Lavagem sossegado a 60°C (buzina off), enxaguamentos e centrifugação final à velocidade seleccionada
<b>Amaciador</b> 		-	1000	3,5	-	-	✓	-	✓	-	-	Enxaguamento e apenas descarga, ou descarga e centrifugação final à velocidade seleccionada
<b>Lavagem à mão</b> 	Roupas a refrescar		800	2	-	✓	✓	-	-	-	-	Lavagem com água fria, enxaguamentos e centrifugação final à velocidade seleccionada
<b>Camisas / Trabalho</b> 	Roupas a refrescar	/ 20°	800	2	-	✓	✓	-	✓	✓	✓	Lavagem com água fria ou a 20°C, enxaguamentos e centrifugação final à velocidade seleccionada
	Roupas pouco sujas	30° / 40°	800	2	-	✓	✓	-	✓	-	✓	Lavagem a 30° ou a 40°C, enxaguamentos e centrifugação final à velocidade seleccionada
<b>Jeans</b> 	Roupas a refrescar	/ 20°	800	2	-	✓	✓	-	✓	-	✓	Lavagem com água fria ou a 20°C, enxaguamentos e centrifugação final à velocidade seleccionada
	Roupas pouco sujas	30° / 40°	800	2	-	✓	✓	-	✓	-	✓	Lavagem a 30° ou a 40°C, enxaguamentos e centrifugação final à velocidade seleccionada
<b>Sport</b> 	Roupas a refrescar	/ 20°	800	2	-	✓	✓	-	✓	-	✓	Lavagem com água fria ou a 20°C, enxaguamentos e centrifugação final à velocidade seleccionada
	Roupas pouco sujas	30° / 40°	800	2	-	✓	✓	-	✓	-	✓	Lavagem a 30° ou a 40°C, enxaguamentos e centrifugação final à velocidade seleccionada
<b>Tecidos mistos</b> 	Roupas de algodão e sintéticas a refrescar	/ 20°	Máx.	3	✓	✓	✓	✓	✓	✓	✓	Lavagem com água fria ou a 20°C, enxaguamentos e centrifugação final à velocidade seleccionada
	Roupas de algodão e sintéticas pouco sujas	30° / 40°	Máx.	3	✓	✓	✓	✓	✓	✓	✓	Lavagem a 30° ou a 40°C, enxaguamentos e centrifugação final à velocidade seleccionada

✓ Opção disponível



: Opções que não podem ser seleccionadas simultaneamente

PROGRAMTABELL

Program		Temp. (°C)	Max. centrifugering (varv/mino)	Max. tvättmängd (kg)	Tvättmedelslådans fack			Funktioner					Beskrivning av tvättprogram
					Förtvätt	Huvud-tvätt	Sköljmedel	Förtvätt	Intensiv	Skrynkel-fritt	Extra-sköljning	Snabb	
<b>Vittvätt och kulörtvätt</b>		Lätt smutsad fintvätt/kulörtvätt	/ 20°	Max.	7	✓	✓	✓	✓	✓	✓	✓	Kalltvätt eller 20 °C, sköljning och slutcentrifugering på valt centrifugeringsvarvtal
		Normalt smutsad fintvätt/kulörtvätt	30° / 40°	Max.	7	✓	✓	✓	✓	-	✓	✓	Tvättning på 30° eller 40 °C, sköljning och slutcentrifugering på valt centrifugeringsvarvtal
		Normalt smutsad slitstark kulörtvätt	60°	Max.	7	✓	✓	✓	✓	-	✓	✓	Tvättning på 60 °C, sköljning och slutcentrifugering på valt centrifugeringsvarvtal
		Hårt smutsad slitstark kulörtvätt	90°	Max.	7	✓	✓	✓	✓	✓	✓	✓	Tvättning på 90 °C, sköljning och slutcentrifugering på valt centrifugeringsvarvtal
<b>Eco 40-60</b>		Normalt smutsig bomullstvätt, förklarad tvättbar vid 60°C eller 40°C tillsammans	-	Max.	7	✓	✓	✓	✓	-	✓	✓	Tvättar, sköljer och centrifugerar vid vald hastighet
<b>Syntettvätt</b>		Uppfräschning av plagg	/ 20°	1000	3,5	✓	✓	✓	✓	-	✓	✓	Kalltvätt eller 20 °C, sköljning och slutcentrifugering på valt centrifugeringsvarvtal
		Lätt smutsade plagg	30° / 40°	1000	3,5	✓	✓	✓	✓	-	✓	✓	Tvättning på 30° eller 40 °C, sköljning och slutcentrifugering på valt centrifugeringsvarvtal
		Normalt smutsade plagg	60°	1000	3,5	✓	✓	✓	✓	-	✓	✓	Tvättning på 60 °C, sköljning och slutcentrifugering på valt centrifugeringsvarvtal
<b>Fintvätt och silke</b>		Uppfräschning av plagg	/ 20°	600	2	-	✓	✓	-	✓	-	-	Kalltvätt eller 20 °C, sköljning och slutcentrifugering på valt centrifugeringsvarvtal
		Lätt smutsade plagg	30° / 40°	600	2	-	✓	✓	-	✓	-	-	Tvättning på 30° eller 40 °C, sköljning och slutcentrifugering på valt centrifugeringsvarvtal
<b>Ylle</b>		Uppfräschning av plagg	/ 20°	800	2	-	✓	✓	-	-	-	-	Kalltvätt eller 20 °C, sköljning och slutcentrifugering på valt centrifugeringsvarvtal
		Lätt smutsade plagg	30° / 40°	800	2	-	✓	✓	-	-	-	-	Tvättning på 30° eller 40 °C, sköljning och slutcentrifugering på valt centrifugeringsvarvtal
<b>Sköljning och centrifugering</b>		-	Max.	7	-	-	✓	-	-	✓	-	✓	Sköljning och endast tömning, eller tömning och slutcentrifugering på valt centrifugeringsvarvtal
<b>Tömning och centrifugering</b>		-	Max.	7	-	-	-	-	-	✓	-	✓	Endast tömning, eller tömning och slutcentrifugering på valt centrifugeringsvarvtal
<b>Snabb</b>		Uppfräschning av lätt smutsad vittvätt eller fintvätt	/ 20° / 30°	800	2	-	✓	✓	-	-	-	-	Kalltvätt eller tvättning → 20° / 30 °C, sköljning och slutcentrifugering på valt centrifugeringsvarvtal
<b>Nattprogram</b>		Lätt smutsad ömtålig fintvätt	/ 20°	1000	3	✓	✓	✓	✓	✓	-	✓	Tyst kalltvätt eller tvättning → 20 °C (ingen ljudsignal), sköljning och slutcentrifugering på valt centrifugeringsvarvtal
		Lätt smutsade plagg	30° / 40°	1000	3	✓	✓	✓	✓	✓	-	✓	Tyst tvättning på 30° / 40 °C (ingen ljudsignal), sköljning och slutcentrifugering på valt centrifugeringsvarvtal
		Normalt smutsade plagg	60°	1000	3	✓	✓	✓	✓	✓	-	✓	Tyst tvättning på 60 °C (ingen ljudsignal), sköljning och slutcentrifugering på valt centrifugeringsvarvtal
<b>Sköljmedel</b>		-	1000	3,5	-	-	✓	-	-	✓	-	-	Sköljning och endast tömning, eller tömning och slutcentrifugering på valt centrifugeringsvarvtal
<b>Handtvätt</b>		Uppfräschning av plagg		800	2	-	✓	✓	-	-	-	-	Kalltvätt, sköljning och slutcentrifugering på valt centrifugeringsvarvtal
<b>Skjortor / Arbetskläder</b>		Uppfräschning av plagg	/ 20°	800	2	-	✓	✓	-	✓	✓	✓	Kalltvätt eller 20 °C, sköljning och slutcentrifugering på valt centrifugeringsvarvtal
		Lätt smutsade plagg	30° / 40°	800	2	-	✓	✓	-	✓	-	✓	Tvättning på 30° eller 40 °C, sköljning och slutcentrifugering på valt centrifugeringsvarvtal
<b>Jeans</b>		Uppfräschning av plagg	/ 20°	800	2	-	✓	✓	-	✓	✓	✓	Kalltvätt eller 20 °C, sköljning och slutcentrifugering på valt centrifugeringsvarvtal
		Lätt smutsade plagg	30° / 40°	800	2	-	✓	✓	-	✓	-	✓	Tvättning på 30° eller 40 °C, sköljning och slutcentrifugering på valt centrifugeringsvarvtal
<b>Sport</b>		Uppfräschning av plagg	/ 20°	800	2	-	✓	✓	-	✓	-	✓	Kalltvätt eller 20 °C, sköljning och slutcentrifugering på valt centrifugeringsvarvtal
		Lätt smutsade plagg	30° / 40°	800	2	-	✓	✓	-	✓	-	✓	Tvättning på 30° eller 40 °C, sköljning och slutcentrifugering på valt centrifugeringsvarvtal
<b>Blandad tvätt</b>		Uppfräschning av vittvätt/syntettvätt	/ 20°	Max.	3	✓	✓	✓	✓	✓	✓	✓	Kalltvätt eller 20 °C, sköljning och slutcentrifugering på valt centrifugeringsvarvtal
		Lätt smutsad vittvätt/syntettvätt	30° / 40°	Max.	3	✓	✓	✓	✓	✓	✓	✓	Tvättning på 30° eller 40 °C, sköljning och slutcentrifugering på valt centrifugeringsvarvtal

✓: Funktionen går att välja



: Funktioner som inte kan väljas samtidigt

**ВЫБОР ПРОГРАММ**

Программы	Темп. (°C)	Макс. отжим (об/мин)	Макс. загрузка для стирки (кг)	Отсеки дозатора для моющих средств			Дополнительные функции					Описание программы стирки	
				Предварительная стирка	Стирка	Смягчитель	Предварительная стирка	Интенсивная	Гладьте меньше	Дополнительное полоскание	Быстрая		
<b>Хлопок и цветное белье</b>	Цветные тонкие ткани с небольшим загрязнением	/ 20°	Макс.	7	✓	✓	✓	✓	✓	✓	✓	✓	Холодная стирка или 20°C, полоскания и конечный отжим на выбранной скорости
	Цветные тонкие ткани с обычным загрязнением	30° / 40°	Макс.	7	✓	✓	✓	✓	-	✓	✓	✓	Стирка при 30° или 40°C, полоскания и конечный отжим на выбранной скорости
	Стойкое цветное белье с обычным загрязнением	60°	Макс.	7	✓	✓	✓	✓	-	✓	✓	✓	Стирка при 60°C, полоскания и конечный отжим на выбранной скорости
	Стойкое цветное белье с сильным загрязнением	90°	Макс.	7	✓	✓	✓	✓	✓	✓	✓	✓	Стирка при 90°C, полоскания и конечный отжим на выбранной скорости
<b>Эко 40-60</b>	Белье из хлопка средней степени загрязнения можно стирать вместе при температуре 60°C или 40°C	-	Макс.	7	✓	✓	✓	✓	-	✓	✓	✓	Стирка, полоскание и окончательный отжим на выбранной скорости
<b>Синтетика</b>	Освежение одежды	/ 20°	1000	3,5	✓	✓	✓	✓	✓	-	✓	✓	Холодная стирка или 20°C, полоскания и конечный отжим на выбранной скорости
	Белье с небольшим загрязнением	30° / 40°	1000	3,5	✓	✓	✓	✓	✓	-	✓	✓	Стирка при 30° или 40°C, полоскания и конечный отжим на выбранной скорости
	Белье с обычным загрязнением	60°	1000	3,5	✓	✓	✓	✓	✓	-	✓	✓	Стирка при 60°C, полоскания и конечный отжим на выбранной скорости
<b>Тонкие ткани / шелк</b>	Освежение одежды	/ 20°	600	2	-	✓	✓	-	✓	-	✓	-	Холодная стирка или 20°C, полоскания и конечный отжим на выбранной скорости
	Белье с небольшим загрязнением	30° / 40°	600	2	-	✓	✓	-	✓	-	✓	-	Стирка при 30° или 40°C, полоскания и конечный отжим на выбранной скорости
<b>Шерсть</b>	Освежение одежды	/ 20°	800	2	-	✓	✓	-	-	-	-	-	Холодная стирка или 20°C, полоскания и конечный отжим на выбранной скорости
	Белье с небольшим загрязнением	30° / 40°	800	2	-	✓	✓	-	-	-	-	-	Стирка при 30° или 40°C, полоскания и конечный отжим на выбранной скорости
<b>Полоскание и отжим</b>		-	Макс.	7	-	-	✓	-	-	✓	-	✓	Полоскание и только слив или слив и конечный отжим на выбранной скорости
<b>Слив и отжим</b>		-	Макс.	7	-	-	-	-	-	✓	-	✓	Только слив или слив и конечный отжим на выбранной скорости
<b>Быстрая</b>	Освежение легкого хлопка или тонких тканей	/ 20° / 30°	800	2	-	✓	✓	-	-	-	-	-	Холодная стирка → 20° / 30°C, полоскания и конечный отжим на выбранной скорости
<b>Ночная стирка</b>	Очень тонкие ткани с небольшим загрязнением	/ 20°	1000	3	✓	✓	✓	✓	✓	✓	-	✓	Бесшумная холодная стирка → 20°C (звуковой сигнал выкл.), полоскания и конечный отжим на выбранной скорости
	Ткани с небольшим загрязнением	30° / 40°	1000	3	✓	✓	✓	✓	✓	✓	-	✓	Бесшумная стирка при 30° / 40°C (звуковой сигнал выкл.), полоскания и конечный отжим на выбранной скорости
	Ткани с обычным загрязнением	60°	1000	3	✓	✓	✓	✓	✓	✓	-	✓	Бесшумная стирка при 60°C (звуковой сигнал выкл.), полоскания и конечный отжим на выбранной скорости
<b>Смягчитель</b>		-	1000	3,5	-	-	✓	-	-	✓	-	-	Полоскание и только слив или слив и конечный отжим на выбранной скорости
<b>Ручная стирка</b>	Освежение одежды		800	2	-	✓	✓	-	-	-	-	-	Холодная стирка, полоскания и конечный отжим на выбранной скорости
<b>Сорочки / Рабочая одежда</b>	Освежение одежды	/ 20°	800	2	-	✓	✓	-	✓	-	✓	✓	Холодная стирка или 20°C, полоскания и конечный отжим на выбранной скорости
	Белье с небольшим загрязнением	30° / 40°	800	2	-	✓	✓	-	✓	-	✓	✓	Стирка при 30° или 40°C, полоскания и конечный отжим на выбранной скорости
<b>Jeans</b>	Освежение одежды	/ 20°	800	2	-	✓	✓	-	✓	-	✓	✓	Холодная стирка или 20°C, полоскания и конечный отжим на выбранной скорости
	Белье с небольшим загрязнением	30° / 40°	800	2	-	✓	✓	-	✓	-	✓	✓	Стирка при 30° или 40°C, полоскания и конечный отжим на выбранной скорости
<b>Sport</b>	Освежение одежды	/ 20°	800	2	-	✓	✓	-	✓	-	✓	✓	Холодная стирка или 20°C, полоскания и конечный отжим на выбранной скорости
	Белье с небольшим загрязнением	30° / 40°	800	2	-	✓	✓	-	✓	-	✓	✓	Стирка при 30° или 40°C, полоскания и конечный отжим на выбранной скорости
<b>Ткани из смешанных волокон</b>	Освежение Хлопок и синтетика	/ 20°	Макс.	3	✓	✓	✓	✓	✓	✓	✓	✓	Холодная стирка или 20°C, полоскания и конечный отжим на выбранной скорости
	Хлопок и синтетика с небольшим загрязнением	30° / 40°	Макс.	3	✓	✓	✓	✓	✓	✓	✓	✓	Стирка при 30° или 40°C, полоскания и конечный отжим на выбранной скорости

✓: Доступная дополнительная функция



: Функции, которые нельзя выбрать одновременно