

EN

User Manual
Washing Machine

WASHING MACHINE

User Manual

LBW710IT

 smeg

CONTENTS

CHAPTER-1: BEFORE USING THE APPLIANCE

- Correct Usage 6-7
- General warnings 8-9-10-11
- Safety warnings 12-13-14-15-16-17
- Packaging and Environment..... 18
- Savings Information.....19

CHAPTER-2: OVERVIEW OF YOUR DEVICE

- General Appearance..... 20-21
- Specifications.....22

CHAPTER-3: INSTALLATION

- Removing transportation safety screws.....23-24
- Adjusting Adjustable Stays..... 25-26-27
- Electrical connection.....28
- Water inlet hose connection 29-30
- Water discharge connection..... 31

CHAPTER-4: INTRODUCTION OF CONTROL PANEL32

- Detergent drawer.....33-34
- Programme knob.....35
- Electronic display.....36-37

CHAPTER-5 PRELIMINARY PREPARATION FOR LAUNDERING

- Separating laundries 38-39

CONTENTS

•	Putting laundries in the machine	40
•	Adding detergent into machine	41
•	Operating your machine.....	42-43-44
•	Auxiliary Functions.....	45-46-47-48-49-50-51-52
•	Child lock	53
•	Cancelling programme.....	54
•	Finishing programme	55
CHAPTER-6:	PROGRAM TABLE	56-57-58-59-60-61-62-63
CHAPTER-7:	MAINTENANCE AND CLEANING OF YOUR MACHINE	
•	Warning.....	64
•	Water inlet filters.....	65
•	Pump filter.....	66-67
•	Detergent drawer.....	68
•	Liquid detergent apparatus.....	68
CHAPTER-8:	FLUSH STOPPER / BODY / DRUM	69
CHAPTER-9:	TROUBLE SHOOTING.....	70-71-72-73-77
CHAPTER-10:	AUTOMATIC FAULT WARNINGS AND WHAT TO BE DONE	75
CHAPTER-11:	PRACTICAL INFORMATION	76-77-78-79
•	How to read the energy label and saving energy	80-81
•	Disposal of your old machine.....	82

CHAPTER -1: BEFORE USING THE APPLIANCE (SAFETY WARNINGS)

Operating voltage / frequency:
(V/Hz) (220-240) V~/50Hz;
Total current (A): 10
Water pressure (Mpa)
Maximum: 1 Mpa / Minimum : 0.1 Mpa
Total power (W) : 2200
Maximum dry laundry capacity (kg): 7

Do not install your machine on a carpet or such grounds that would prevent the ventilation of its base.

The appliance is not intended for use by people (including children) with reduced physical, sensory or mental capabilities, or lack of experience and knowledge unless they have been given supervision or instruction concerning use of the appliance by a person responsible for their safety.

Children should be supervised to ensure that they do not play with the appliance.

Call the nearest authorized service for a replacement if the power cord malfunctions.

CHAPTER -1: BEFORE USING THE APPLIANCE (SAFETY WARNINGS)

Use only the new water inlet hose coming with your machine while making water inlet connections of your machine. Never use old, used or damaged water inlet hoses.

This appliance can be used by children aged from 8 years and above and persons with reduced physical, sensory or mental capabilities or lack of experience and knowledge if they have been given supervision or instruction concerning use of the appliance in a safe way and understand the hazards involved.

Children shall not play with the appliance. Cleaning and user maintenance shall not be made by children without supervision.

Note: For softcopy of this user manual, please contact following address: "washingmachine@standardtest.info". In your e-mail, please provide the model name and serial number (20 digits) which you can find on the appliance door.

CHAPTER -1: BEFORE USING THE APPLIANCE (CORRECT USAGE)

- **Definitely read the user's manual.**
- **Your machine is designed to be used domestically. Commercial use will cause your warranty to be cancelled.**



- Keep your pets away from your machine.
- Please check the packaging of your machine before installation, and the outer surface after the package is opened. Do not operate damaged machines or machines with opened package.
- Have your machine installed only by authorized service. Any interference to your machine by anyone other than authorized services shall cause your warranty to be void.
- The appliance is not intended for use by people (including children) with reduced physical, sensory or mental capabilities, or lack of experience and knowledge unless they have been given supervision or instruction concerning use of the appliance by a person responsible for their safety. Children should be supervised to ensure that they do not play with the appliance.

CHAPTER -1: BEFORE USING THE APPLIANCE (CORRECT USAGE)

- Use your machine only for laundries that have been specified as suitable for washing by the manufacturer.

- **Before operating the washing machine, remove the 4 transportation screws and rubber spacers from the back of the machine. If the screws are not removed, it may cause heavy vibration, noise and product malfunction, (voiding the guarantee).**

- Your machine is not covered under warranty for faults caused by any kind of external factors (pesticides, fire, etc.).

- Please do not throw away this user manual; keep it for future reference. You or somebody else might need it in the future.

Note: Machinery specifications may vary depending on the product purchased.

CHAPTER -1: BEFORE USING THE APPLIANCE (GENERAL WARNINGS)

- The necessary ambient temperature for your machine's ideal operation is 15-25°.
 - Frozen hoses can tear and explode. In regions where temperature is below zero, ambient temperature might endanger the safe operation of electronic card.
 - Please ensure that the clothes you will place in your machine do not contain any foreign substances (nail, needle, coins, lighter, matches, clip etc.) in their pockets. These foreign substances can damage your machine.
 - Before starting to use your machine, you may call the nearest authorized service and request free-of-charge help for installation, operation and use of your machine.
- It is recommended to perform the first washing operation in 90° Cotton programme and without laundry by inserting ½ scale of detergent in 2nd compartment of the detergent drawer.**

CHAPTER -1: BEFORE USING THE APPLIANCE (GENERAL WARNINGS)

- As detergent or softener exposed to air for a long time may cause residues, put your detergent or softener in the detergent drawer at the beginning of every washing.
- It is advised that you unplug your machine and close the water inlet tap if you will not use your machine for a long time. Also, leaving the door of your machine will prevent the formation of bad odors due to humidity.
- Some water might be left in your machine after the trials and tests conducted due to Quality Control procedures. This will not damage your machine.
- Remember that packaging materials of your machine may be dangerous for children.
- Keep the packaging materials in a place where children cannot reach or dispose of them appropriately.
- Use pre-wash programs only for very dirty laundry.

CHAPTER -1: BEFORE USING THE APPLIANCE (GENERAL WARNINGS)

- Never open the detergent drawer when the appliance is running.



- In case of any breakdown, unplug the appliance first and then turn the tap off. Do not attempt to repair by yourself, always contact for authorized service advice.

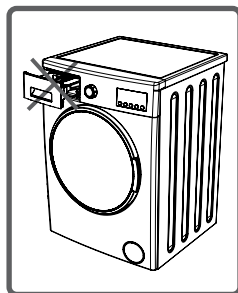

- The amount of laundry you put in your washing machine should not exceed the maximum amount indicated.

- Never force the door to open when the machine is running.

- Washing floury clothes in your machine damages the machine. Do not wash floury clothes in your machine.

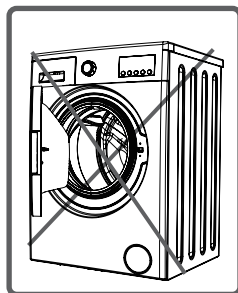

CHAPTER -1: BEFORE USING THE APPLIANCE (GENERAL WARNINGS)

- Please adhere to detergent/fabric conditioner manufacturers' the use of fabric conditioner or similar products in your machine.
- Set up your machine in a place where its door can be completely opened. (Do not set up your machine in places where its door cannot be fully opened.)
- Set up your machine at locations that can be fully ventilated and could have constant air circulation.

CHAPTER -1: BEFORE USING THE APPLIANCE (SAFETY WARNINGS)

You must read these warnings. You can thus protect yourself and your beloved ones against fatal injuries and risks.



DANGER OF GETTING BURNT!



Do not touch discharging hose and water during discharging as the appliance may reach high temperatures when running.

DEATH RISK DUE TO ELECTRICAL CURRENT!



• Do not use multiple receptacles or extension cord.

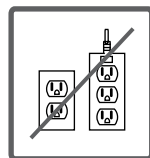

• Do not plug in damaged plug sockets

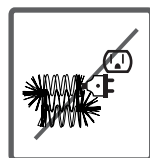

• Never pull the cable when unplugging – always grip the plug itself.

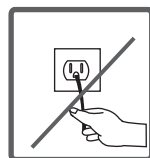

• Do not plug-in or out the plug from the receptacle with wet hands to prevent electrocution!

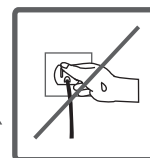

• Never touch the machine with wet hands or feet. 

• Call the nearest authorized service for a replacement if the power cord malfunctions.

Flooding risk!



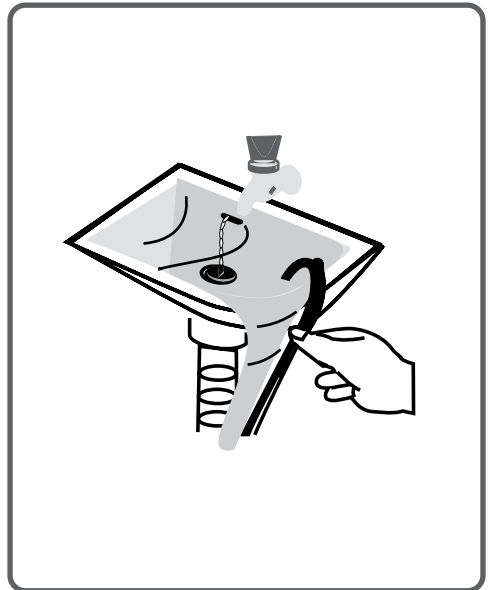
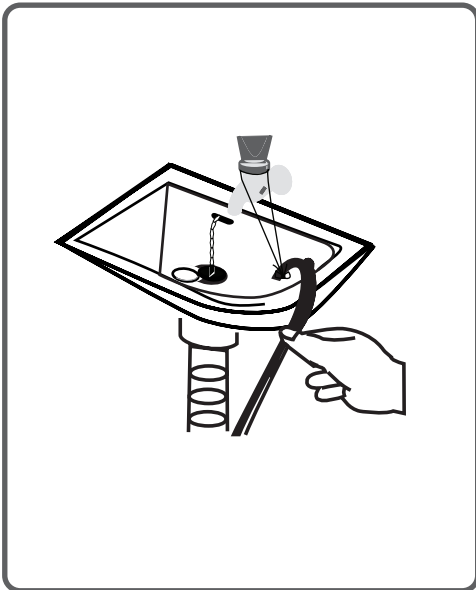

- Check whether the water runs fast or not before placing the discharge hose on the sink.
- Take necessary measures to prevent the slipping of your hose.
- The backfiring force of a hose that is not placed appropriately can displace the hose. Prevent the stopper inside your sink from blocking the sink hole.



Danger of Fire!



- Do not keep inflammable liquids near your machine.
- The sulphure content of paint removers might cause corrosion. For this reason, never use paint-removing materials in your machine.
- Never use products that contain solvent material (like washing gas) in your machine.  
- Remove all the objects in the pockets of your laundries (needle, paperclip, lighter, matches etc.) when placing them your machine.

Fire and Explosion risk may occur.

Fall and injury hazard!



- Do not climb on your machine. The upper table of your machine may break and you might get injured.
- Tidy the hose, cable and packaging of your machine during installation. You might trip over and fall.
- Do not turn your machine upside down, or on its side.
- Do not lift your machine by holding it from extruding parts (detergent drawer, door). These parts might break and cause you to get injured.
- There's the risk of tripping and injury if the materials like hose and cables are not properly stored after your machine is installed.

**Machine must be carried by
2 people or more.**



Child safety!



- Do not leave children unattended near the machine. Children might lock themselves up into the machine and death risk might occur.

- Door glass and surface might be extremely hot while your machine operates. Thus, especially touching the machine might give damage to the skins of children.



- Keep packaging material away from children.

- Poisoning might occur if the detergent and maintenance materials are consumed, and eyes or the skin might be irritated if they come into contact with the skin. Keep the cleaning materials away from the reach of children.

Removal of packaging materials

Packaging materials protect your machine from any damage that might occur during transportation. Packaging materials are environment friendly as they are recyclable. Recycling material provides both raw material savings and decreases waste production.

Disposal of old machine

Electrical or electronic old devices might still contain salvagable parts. So, never throw away your old devices that you do not use into the waste.



Ensure that the parts of your old electronic or electrical devices are reused by giving them to the gathering centres foreseen by related authorities.

Please ensure your old appliances are kept in an appropriate place for the safety of children until they are taken outside the house.

Some important information to get more efficiency out of your machine:

- The amount of laundry you put in your washing machine should not exceed the maximum amount indicated.

By this way, your machine shall run in saving mode.

- Not using the pre-wash feature for little and normal-dirty laundry shall save electricity and water.

**CHAPTER -2: OVERVIEW OF YOUR DEVICE
GENERAL APPEARANCE**

Electronic display

Programme knob

Upper Tray

Detergent drawer

Container

Cover of pump filter

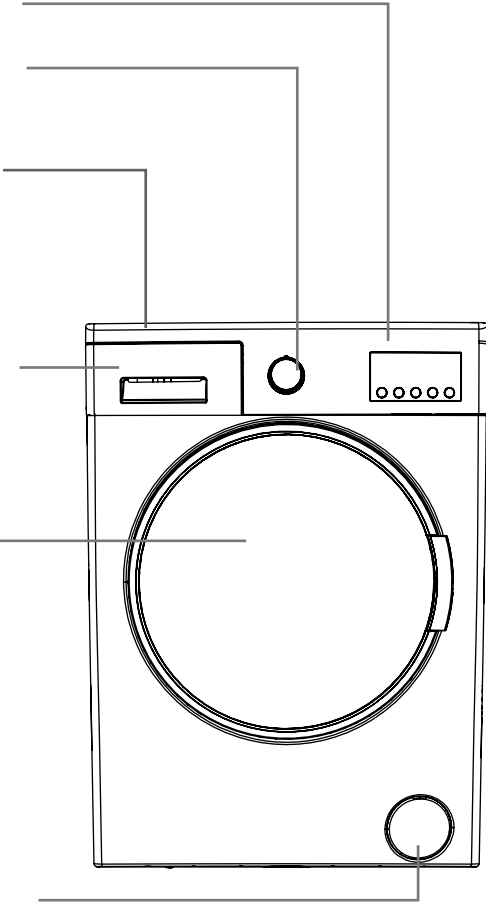

**CHAPTER -2: OVERVIEW OF YOUR DEVICE
GENERAL APPEARANCE**

Transportation Safety
Screw

Water Inlet Valve

Discharging Hose

Power Cable

Transportation Safety Screw

Transportation Safety Screw

Transportation Safety Screw

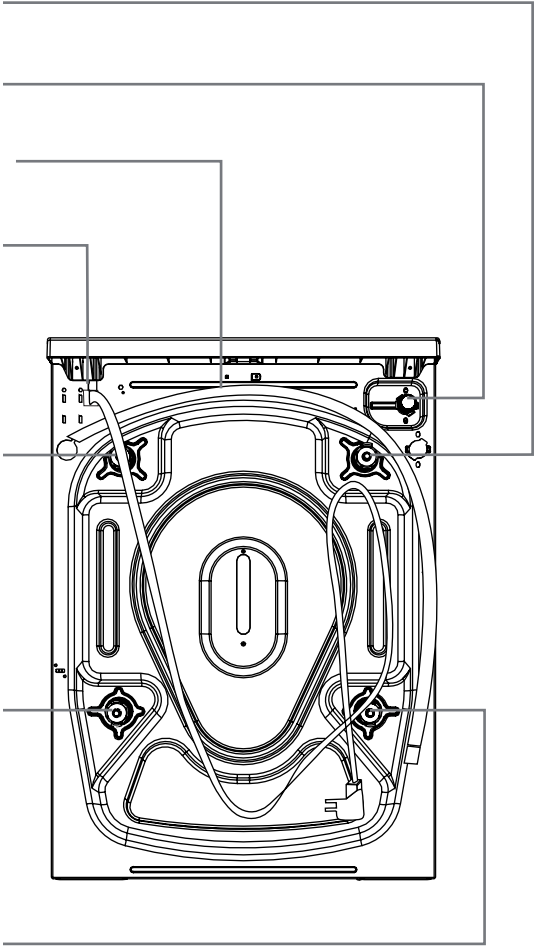

CHAPTER -2: OVERVIEW OF YOUR DEVICE TECHNICAL SPECIFICATIONS

Operating voltage / frequency (V/Hz)	(220-240) V~/50Hz
Total current (A)	10
Water pressure	Maximum: 1 Mpa Minimum : 0.1 Mpa
Total power (W)	2200
Maximum dry laundry capacity (kg)	7
Spinning revolution (rev / min)	1000
Programme number	15
Dimensions (Height x Width x Depth) (mm)	845 x 597 x 527

CHAPTER -3: INSTALLATION OF THE MACHINE REMOVING TRANSPORTATION SAFETY SCREWS



Before operating the washing machine, remove the 4 transportation screws and rubber spacers from the back of the machine. If the screws are not removed, it may cause heavy vibration, noise and product malfunction, (voiding the guarantee).

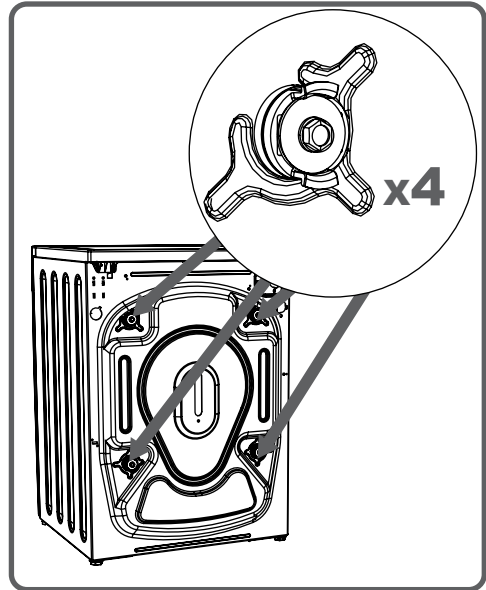

For this reason, transportation safety screws shall be loosened by being rotated in counter-clockwise using an appropriate wrench.

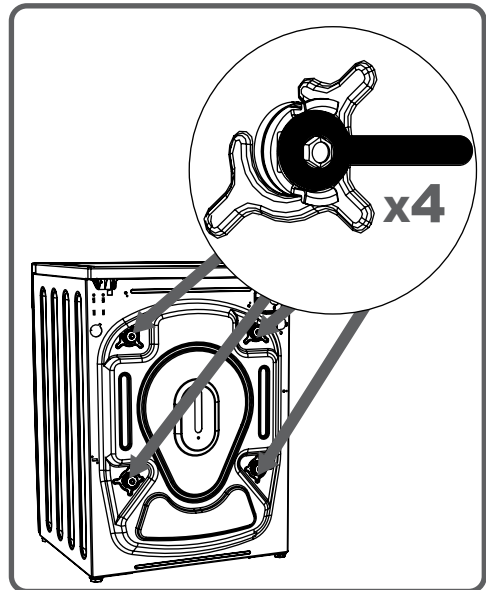

CHAPTER -3: INSTALLATION OF THE MACHINE (REMOVING TRANSPORTATION SAFETY SCREWS)

Transportation screws shall be removed by pulling out.

Fit the plastic transportation screw taps delivered in accessories bag to the places where transportation screws have been removed.

The transportation safety screws should be stored to be used in case of transportation.

NOTE: You should absolutely remove the transportation screws of your machine before the first usage.

Faults occurring in the machines operated with transportation screw fitted shall be out of scope of warranty.

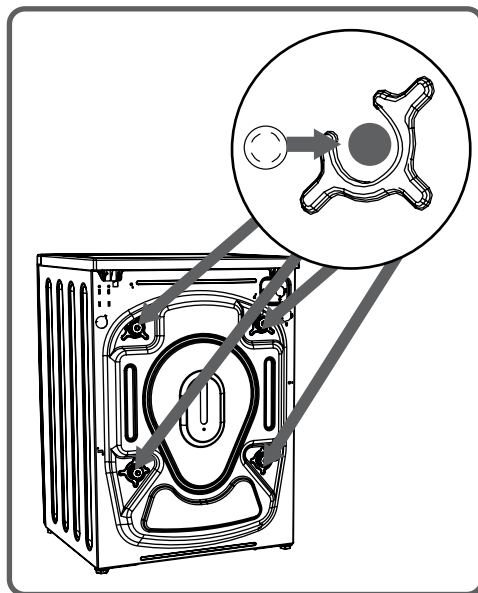
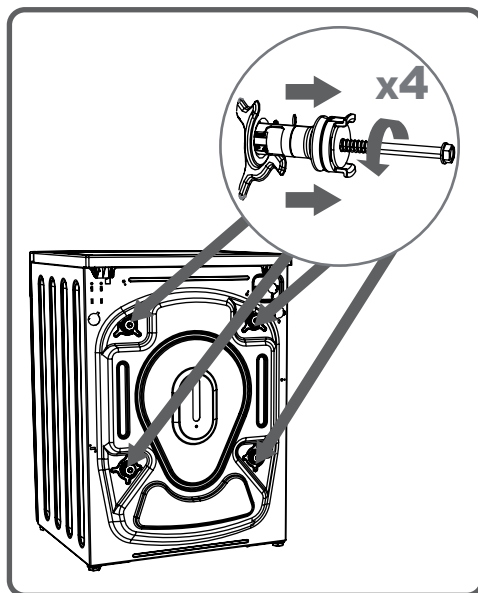

CHAPTER -3: INSTALLATION OF THE MACHINE (Adjusting Adjustable Stays)

- Do not install your machine on a carpet or such grounds that would prevent the ventilation of its base.
- To ensure silent and vibration-free operation of your machine, it should be deployed on a non-sliding and firm ground.
- You can adjust the balance of your machine through the stays.
- Loosen the plastic adjustment nut.

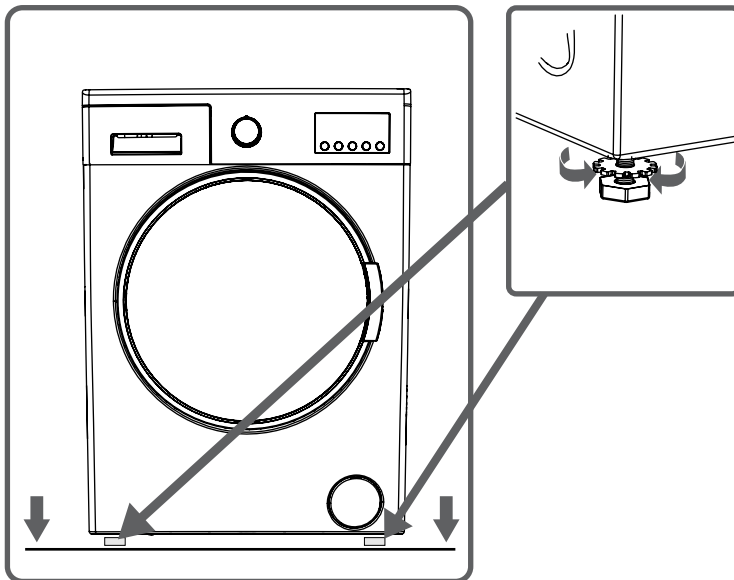

CHAPTER -3: INSTALLATION OF THE MACHINE (ADJUSTING ADJUSTABLE STAYS)

- Adjust the stays upward and downward by rotating them.
- After maintaining the balance, compress the plastic adjustment nut upward again.

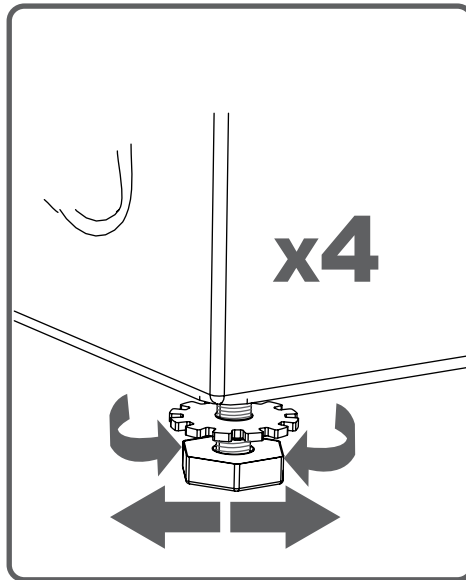

CHAPTER -3: INSTALLATION OF THE MACHINE (ADJUSTING ADJUSTABLE STAYS)

- Never put cardboard, wood or suchlike materials under your machine if you are intending to stabilize the distortions on the ground. 

- When cleaning the ground, on which your machine rests, be careful not to disorder stays stabilization. 

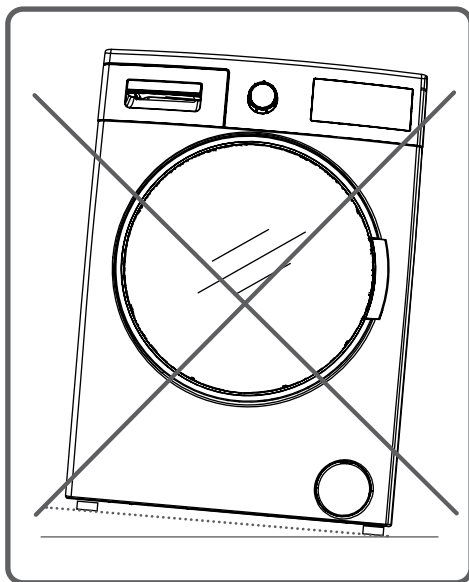

CHAPTER -3: INSTALLATION OF THE MACHINE (ELECTRICAL CONNECTION)

- Your washing machine is set to 220-240V and 50Hz.

- The mains cord of your washing machine is equipped with a specific earthed plug. This plug should always be inserted to a earthed socket of 10 amps.

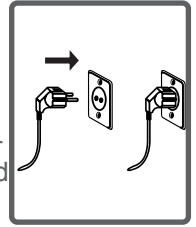

- The current value of the fuse should be 10 amps.

Fuse current value of the power line connected to this plug should also be 10 amperes.

- If you don't have such a receptacle and fuse confirming with this, please have it done by a qualified electrician.

- We do not take the responsibility of the damages that occur due to ungrounded usage.

NOTE: Operating your machine under low voltage will cause the life cycle of your machine to be reduced and its performance to be restricted.

CHAPTER -3: INSTALLATION OF THE MACHINE (WATER INLET HOSE CONNECTION)

- Your machine may have either a single inlet (cold) or double water inlets (cold/hot) based on its specifications. White-capped hose should be connected to cold water inlet and red-capped hose to hot water inlet (applicable for machines with double water inlets).

- To eliminate water leakages in points of contact, 1 or 2 nuts are provided in the hose package (applicable for machines with double water inlets).

Fit these nuts to the ends of new water inlet hoses on the side of faucet.

- Mount new water inlet hoses to a $\frac{3}{4}$ ", threaded faucet.

- Connect the white-elbow end of the water inlet hoses to the white-filtered water inlet valve on the rear side of the machine and the red-elbow end to red-filtered one (applicable for machines with double water inlets).

Tighten plastic parts of the junctions using your hand.

In uncertain conditions, have the connection works be done by a qualified plumber.

- Flow of water with pressure of 0,1-1 Mpa will allow your machine to operate more efficiently.) (0,1 Mpa pressure means that more than 8 litres of water will flow through a fully-tapped faucet per one minute.)

- Ensure that points of contact do not leak by tapping the faucet completely after carrying making the connections.

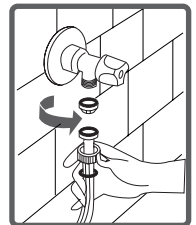
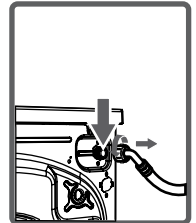
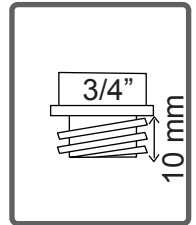
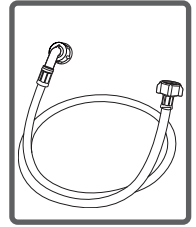

CHAPTER -3: INSTALLATION OF THE MACHINE (WATER INLET HOSE CONNECTION)

- Ensure that the new water inlet hoses are not bent, broken, crushed and resized.
- If your machine has double hot water inlets, the temperature of hot water inlet should be maximum 70°C.

**Note: Use only the new water inlet hose coming with your machine while making water inlet connections of your machine.
Never use old, used or damaged water inlet hoses.**

CHAPTER -3: INSTALLATION OF THE MACHINE (WATER DISCHARGE CONNECTION)

- The end of water discharge hose can be fitted to a specific apparatus directly attached to dirty water discharge hole or outlet joint of the basin elbow.
- Never attempt to extend the water discharge hose by jointing.
- Do not put discharging hose of your machine in a vessel, bucket or sink.
- Make sure that the water discharge hose does not bend, buckle, be crushed or extended. Please note:
 - The water drain hose should be mounted at a height maximum 100 cm from the ground.

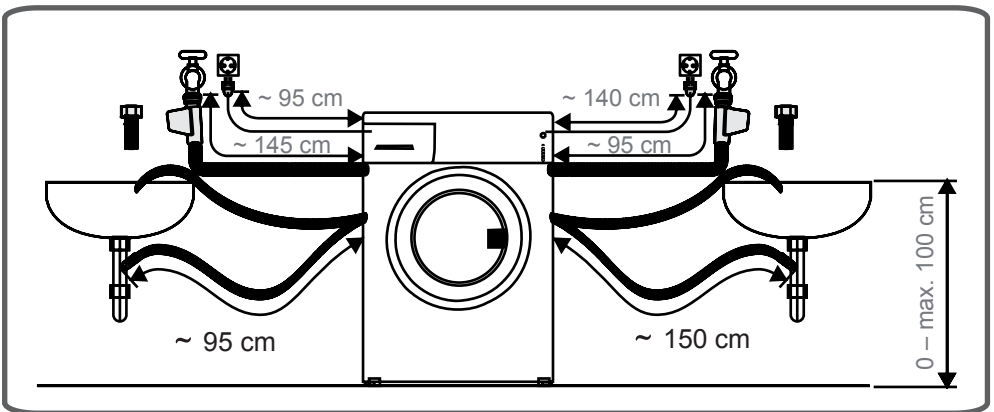
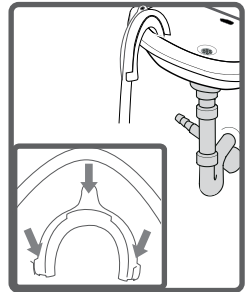
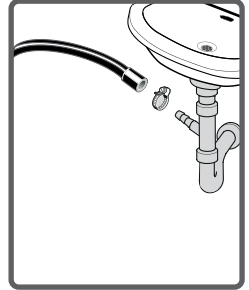

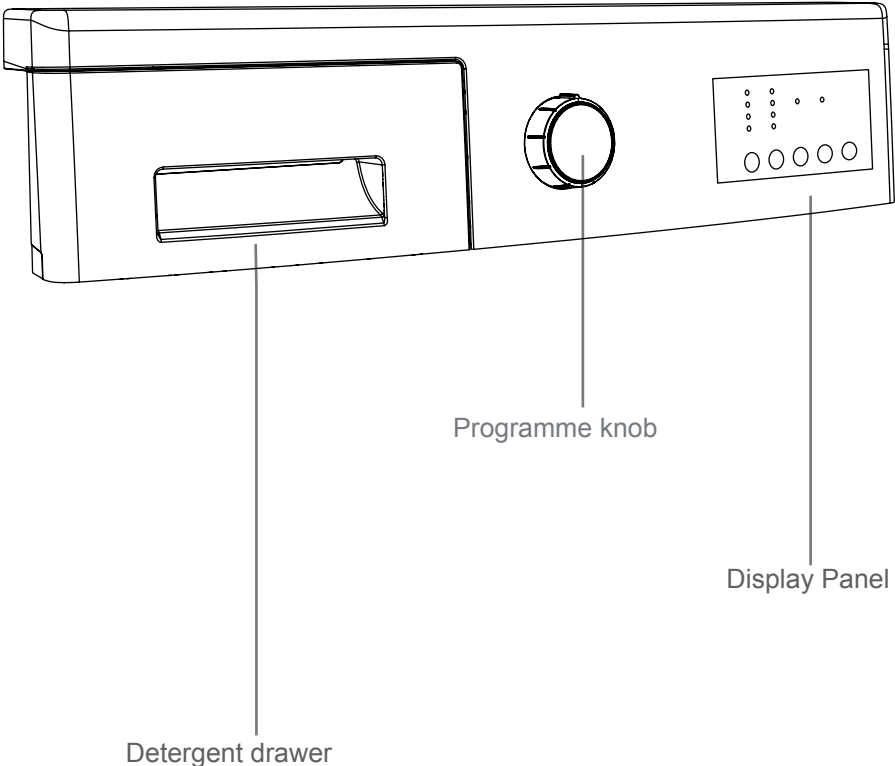

CHAPTER -4: INTRODUCTION OF CONTROL PANEL (DETERGENT DRAWER)

- You can use the liquid level determination plate when you want to wash your laundry with liquid detergent. You can use your liquid detergents in all programs without prewashing. Place the liquid detergent apparatus in the second compartment (which is available inside the machine) of the detergent drawer (*) and set the detergent amount. (Use the recommended amount of liquid detergent by detergent producers). Do not exceed the MAX level, use only for liquid detergent, do not use this apparatus for powder detergent and take it out.)

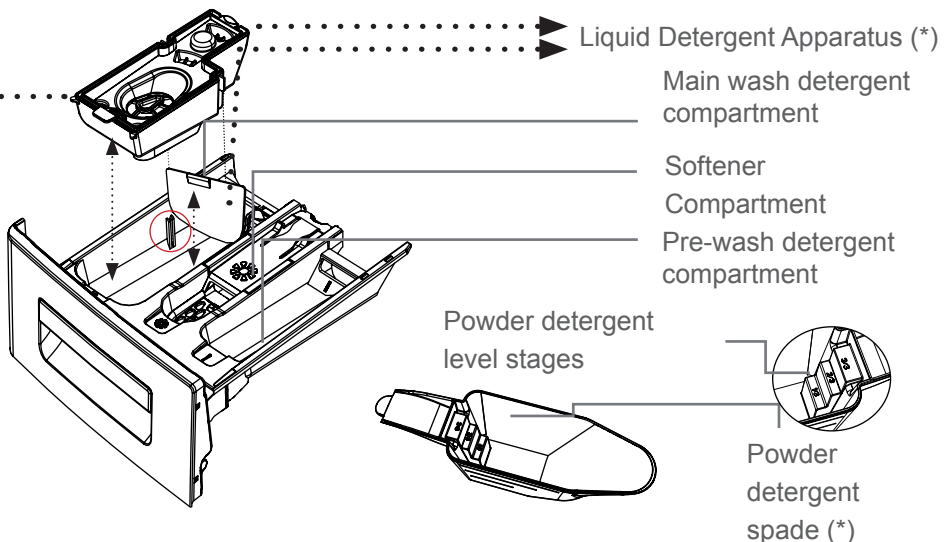
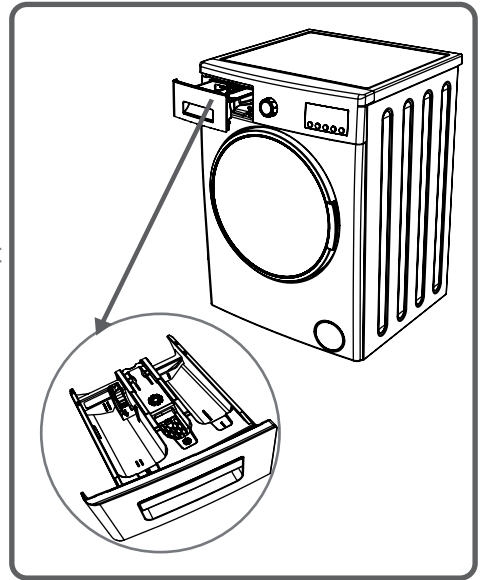

(*) Machinery specifications may vary depending on the product purchased.

SECTIONS

Main wash detergent compartment:

In this compartment, only materials like detergent (liquid or powder), lime preventer and such can be used.

You can find the liquid detergent apparatus inside your machine at first installation. (*)

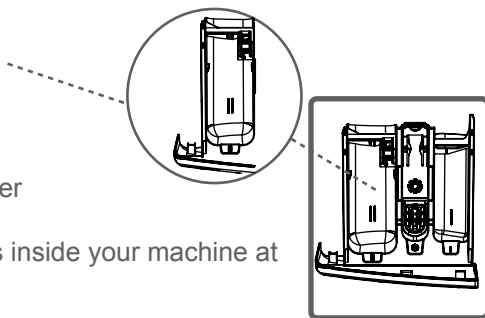

Fabric conditioner, starch, detergent compartment:

You can use softener for your laundry (recommended amount and type by the producer is recommended). Sometimes the fabric conditioners you use for your laundry may remain in this compartment. The reason for this is that the conditioner is not viscous. To prevent this situation, more viscous liquid softeners are recommended to be used or the softener could be thinned and then used.

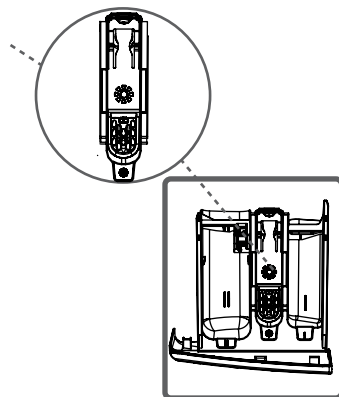

Pre-wash detergent compartment:

This compartment must only be used when the pre-wash feature is selected.

Pre-wash feature is recommended for very dirty laundry.

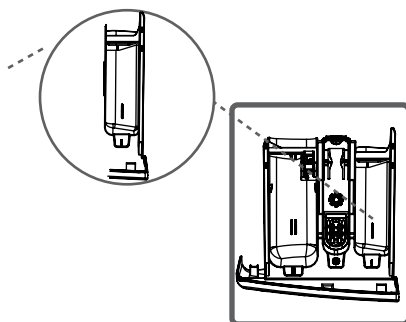

(*) Machinery specifications may vary depending on the product purchased.

CHAPTER -4: INTRODUCTION OF CONTROL PANEL (PROGRAM KNOB)

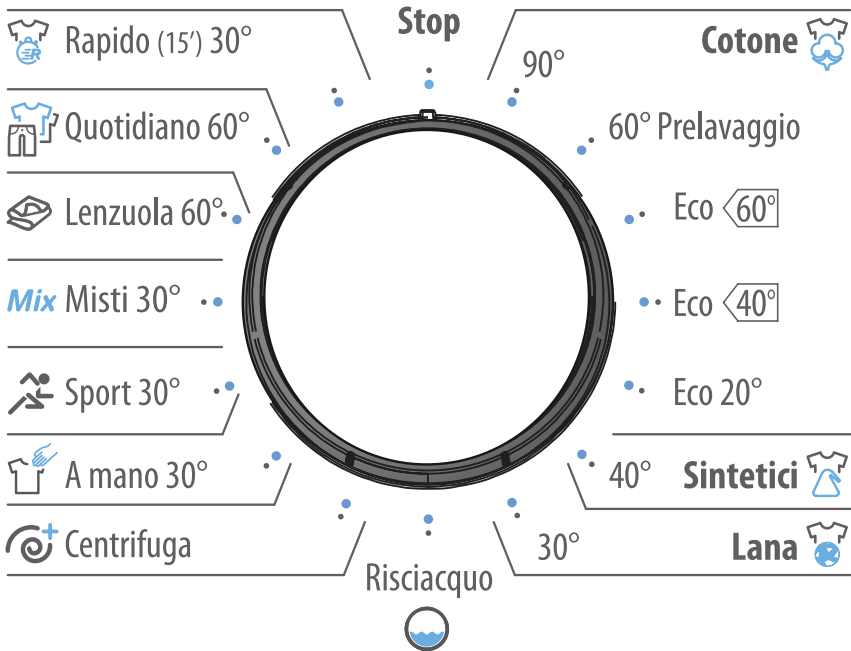

- You can select the programme you want to wash your laundry in through programme knob.
- You may set the programme selection operation by rotating the programme knob in both directions.
- Ensure that the programme knob is exactly on the programme you want to select.

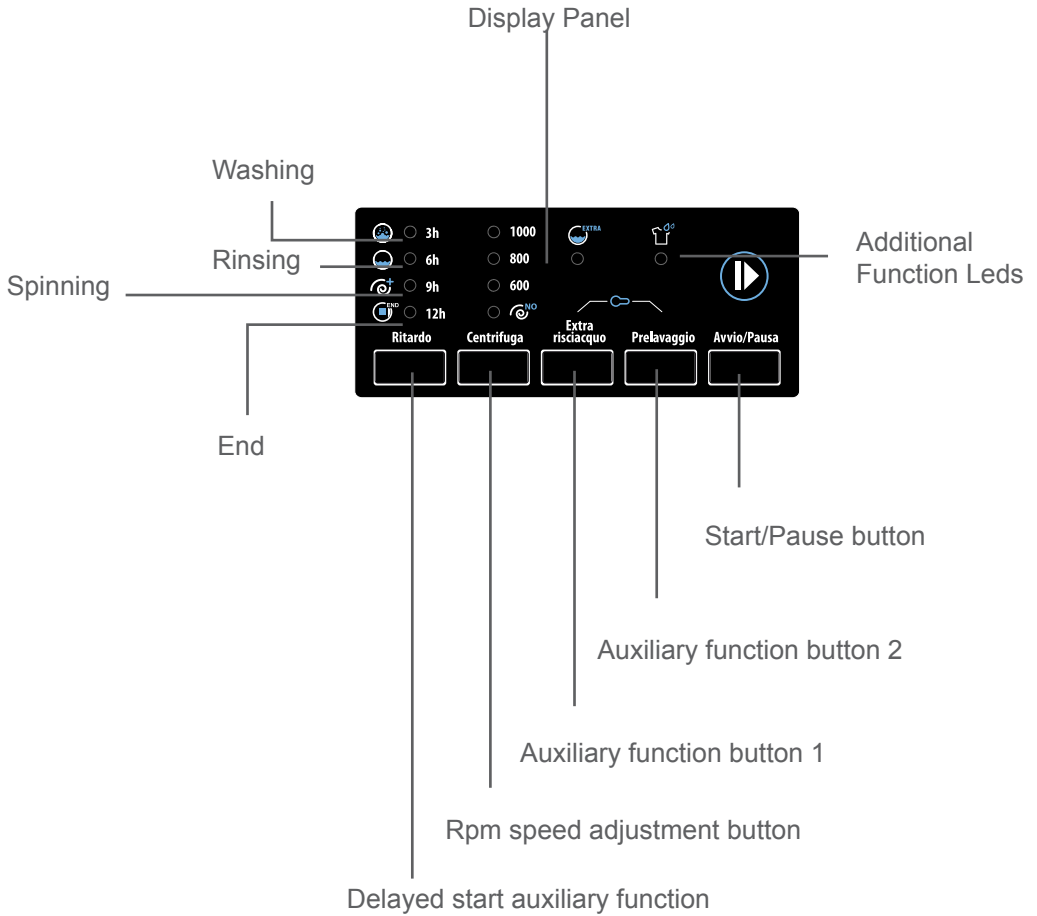

CHAPTER -4: INTRODUCTION OF CONTROL PANEL (ELECTRONIC DISPLAY)



CHAPTER -4: INTRODUCTION OF CONTROL PANEL (ELECTRONIC DISPLAY)

On the display panel, you can see the washing delay timer of your machine, speed setting of your machine, the auxiliary functions you have selected and the stage of the programme you are running on your machine (U pre wash/wash state,  rinsing stage,  spinning stage).

Furthermore, electronic display will warn you by means of led combinations that will turn on its display when a fault occurs on your machine and notify you of the completion of the washing programme by revealing expression of “Finished” on the display as soon as the washing programme you have selected has finished as well.

CHAPTER -5: PRELIMINARY PREPARATION FOR LAUNDERING (SEPARATING LAUNDRIES)

- Your laundry has product labels on them that specify their specifications. Wash or dry your laundry according to the specifications on the product label.
- Separate your laundries according to their types (cotton, synthetic, sensitive, wool etc.), their temperatures (cold, 30°, 40°, 60°, 90°) and degree of contamination (slightly stained, stained, highly stained).
- Never wash your coloured and white laundry together.
- Wash your coloured laundries separately in the first washing as they may bleed.
- Ensure that there are no metallic materials on your laundries or in the pockets; if so, take them up.

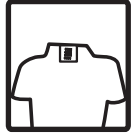

CAUTION: WARNING: Faults that will emerge in case of penetration of foreign substances into your machine are not included within the scope of warranty.



- Zip up and button up your laundries.
- Remove the metallic or plastic hooks of tulle curtains or curtains or place them in a washing net or bag and then muzzle them.
- Reverse textiles such as pants, knitwear, t-shirt and sweat suit.
- Wash socks, handkerchief and suchlike small laundries in a washing net.



CHAPTER -5: PRELIMINARY PREPARATION FOR LAUNDERING (SEPARATING LAUNDRIES)



Whitening available



No whitening



Normal washing

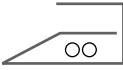

Ironing temperature is maximum 150°C

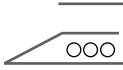

Ironing temperature is maximum 200°C



No ironing



Dry cleaning available



No dry cleaning



Leave on a flat place



Hang when wet



Dry by hanging

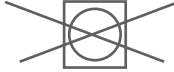

Drying by twirling is not allowed



Dry cleaning in gas oil, pure alcohol and R113 is allowed



Perchloroethylene
R11, R13,
Petroleum



Perchloroethylene
R11, R113, Gas oil

CHAPTER -5: PRELIMINARY PREPARATION FOR LAUNDERING PUTTING LAUNDRIES IN THE MACHINE

- Open the door of your machine.
- Spread your laundries in your machine.

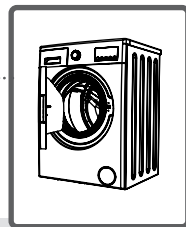

NOTE: Note: Maximum loading capacity may vary based on the laundry type you will wash, degree of contamination and the programme you have chosen. Do not exceed maximum dry loading capacity indicated in the programme table for washing programmes.

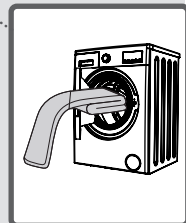

You can take the following table of weights as an example.

LAUNDRY TYPE	WEIGHT (gr)
Towel	200
Linen	500
Bathrobe	1200
Quilt cover	700
Pillow slip	200
Underwear	100
Tablecloth	250

- Put each item of laundry separately.
- Ensure that no laundry is stuck between the cover and bellow seal when closing the door of your machine.
- Push the door of your machine until hearing the locking sound to close it.
- Close the door of your machine properly, otherwise your machine will not start the washing operation.

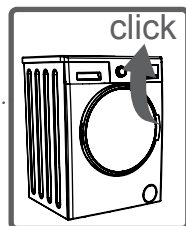

CHAPTER -5: PRELIMINARY PREPARATION FOR LAUNDERING (ADDING DETERGENT INTO MACHINE)

The amount of detergent you will put in your machine will depend on the following criteria:

- Your detergent utilization will be based on the degree of contamination of your laundries. Do not prewash your less stained laundries and put your slight amount of detergent in the 2nd compartment of the detergent drawer.
- For your much stained laundries, select a programme including prewashing, and put $\frac{1}{4}$ of the detergent you will put in the detergent drawer in the 1st compartment of the detergent drawer while putting the remaining $\frac{3}{4}$ of it into 2nd compartment.
- Use detergents produced for automatic washing machine in your machine. The amount of detergent you will use for your laundries is printed on the detergent package.
- The higher the degree of hardness of the water the more detergent you will use.
- The amount of the detergent you will use will increase as the amount of your laundries increase.
- Put the softener in the softener compartment in the detergent drawer. Do not exceed the MAX level. Otherwise, softener will flow into washing water through flushing.
- Softeners with high density are required to be thinned to a degree before being put in the drawer. Because high-density softener will clog the flush and avoid the flow of the softener.
- You can use your liquid detergents in all programs without prewashing. For this, fit liquid detergent level plate in the accessories bag or the liquid detergent apparatus (*) into 2nd compartment of the detergent drawer and set the amount of liquid detergent according to the levels on this plate. Remember to detach the liquid detergent plate.

(*)Machinery specifications may vary depending on the product purchased.

CHAPTER -5: PRELIMINARY PREPARATION FOR LAUNDERING (OPERATING YOUR MACHINE)

- Plug your machine in.
- Open the water faucet.
- Open the machine door.
- Spread your laundries in your machine.
- Push the door of your machine until hearing the locking sound to close it.

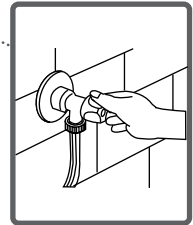
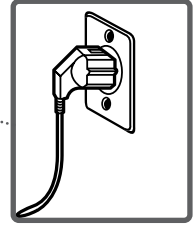

Selecting programme

Select the convenient programme for your laundries on the programme table.

CHAPTER -5: PRELIMINARY PREPARATION FOR LAUNDERING (OPERATING YOUR MACHINE)

AUXILIARY FUNCTIONS

Before starting the programme, you can optionally select an auxiliary function.

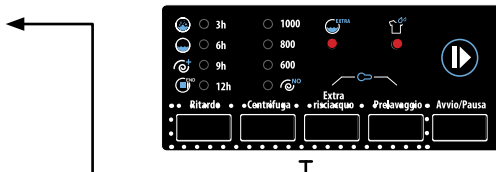

- Press on the button of auxiliary function you would like to select.
- If auxiliary function symbol on electronic display flashes continuously, the auxiliary function you have selected will be activated.
- If auxiliary function symbol on electronic display blinks, the auxiliary function you have selected will not be activated.

Reason for non-activation:

- The auxiliary function you want to use in the washing programme you have selected is not applicable.
- Your machine has passed over the stage, during which the auxiliary function you would like to select would be implemented.
- It is not compatible with an auxiliary function you have selected previously.

HALF-LOAD DETECTION SYSTEM

Your machine features a half-load detection system.

In case you put approximately half or less amount of laundries of maximum laundry capacity in your machine, your machine will run so as to save washing time, water consumption and energy in some programmes. When the half-load function is active, the machine can complete the programme you have set in a shorter time.

CHAPTER-5: PRELIMINARY PREPARATION FOR LAUNDERING AUXILIARY FUNCTIONS

1- Delay timer

By using this auxiliary function, you can make your machine to start the washing operation with delays between “3h, 6h, 9h, 12h”.

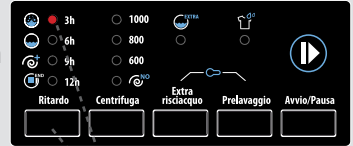

Auxiliary
function
button 1

To use auxiliary function of delayed start:

- Press the delayed start button once.
- “3 h” led shall appear.
- Press on delayed start button until the time, on which you want washing operation to be started.
- To activate the time delay you have selected in the programme, you may press on any auxiliary function button you like except “Start/Standby” button.

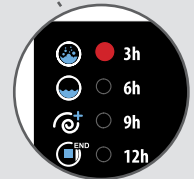

CHAPTER -5: PRELIMINARY PREPARATION FOR LAUNDERING AUXILIARY FUNCTIONS

If you have skipped the time delay you want to set, you can go back to the time desired by keeping pressed on time delay button.

If you want to cancel the time delay, you are required to press the time delay button once symbol will no longer flash on electronic display.



To run time delay function, your machine is required to be operated by pressing on Start/Pause button.



2- Spin Speed Selection

You can adjust the spin speed of your laundry with the spin speed setting button.

When you select a new programme, the max. spin speed of the programme you have selected shall be displayed on the display panel. By pressing the spin speed setting button, you can change the spin speed of the selected programme between its max. value. If you have  skipped the spin speed you want to set, you can re-switch to the revolution by keeping the speed setting button pressed.

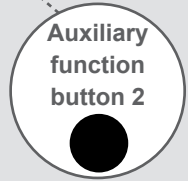

CHAPTER-5: PRELIMINARY PREPARATION FOR LAUNDERING AUXILIARY FUNCTIONS

3- No Spin Button(*)

If you don't want to perform wringing on your laundry, you can use this auxiliary function.

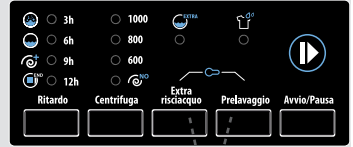

You may make the programme active by pressing the wringing cancel button on the display panel when the led light of the  symbol turns on.

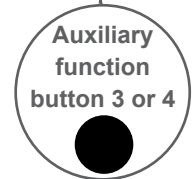

4- Extra Rinse(*)

You can make additional rinse operation on your laundry by using this additional function.



You may make the programme active by pressing the extra rinsing auxiliary function button when the led light of the  symbol turns on.

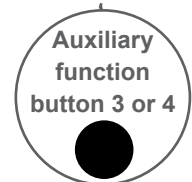

(*) Model Dependant

CHAPTER-5: PRELIMINARY PREPARATION FOR LAUNDERING AUXILIARY FUNCTIONS

5- Pre-wash(*)

You can expose your very dirty laundries to prewashing operation prior to main washing by using this additional function.

When using this function, you should put detergent in front washing compartment of the detergent drawer.

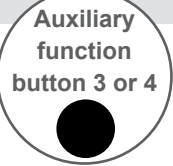
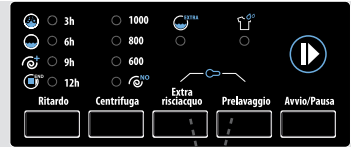

You may make the programme active by pressing the pre-wash button on the display panel when the led light of the  symbol turns on.

6- Anti-Allergic(*)

In the programmes where this auxiliary function is active, you may have your machine perform an extra rinsing operation on your laundries prior to latest rinsing operation.

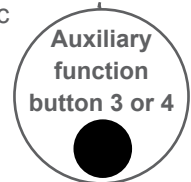

You may make the programme active by pressing the anti-allergic button on the display panel when the led light of the  symbol turns on.

7- Rapid wash(*)

By using this auxiliary function, you can wash your laundry in a shorter time and spending less energy and water. (It is advised that laundry that is less than half the capacity of the selected washing programme is placed.)

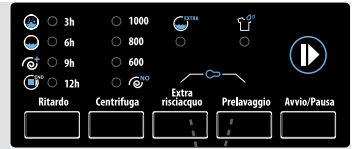

You may make the programme active by pressing the rapid wash button on the display panel when the led light of the  symbol turns on.

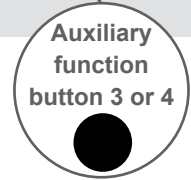

NOTE: In case you put half or less than half of the laundry capacity of the washing programme you have selected in your machine, your machine will detect this thanks to automotive half-load detection system and the programme you have selected will wash your laundries in a shorter time to consume less energy and water. If your machine detects half load, the led of the  symbol will automatically flash on display panel.

(*) Model Dependant

8- Cold Wash(*)

You can use this auxiliary function when you want to wash your laundry with cold water (tap water).

You may make the programme active by pressing the cold washing button on the display panel when the led light of the * symbol turns on.

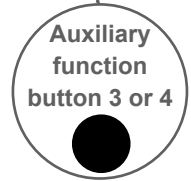

9- Easy ironing(*)

You can enable your laundries to be taken out less wrinkled as the washing operation is completed by employing this auxiliary function.

You may make the programme active by pressing the easy ironing auxiliary function button when the led light of the  symbol turns on.

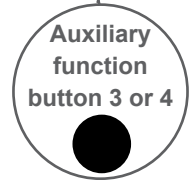

(*) Model Dependant

CHAPTER -5: PRELIMINARY PREPARATION FOR LAUNDERING AUXILIARY FUNCTIONS

Start/Pause button

By pressing on the Start/Pause button, you may start the programme you have selected or suspend a running programme. If you switch your machine to the standby mode, the Start/Pause led on the electronic display will blink.

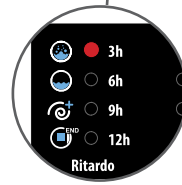
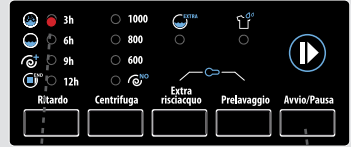

CHAPTER-5: PRELIMINARY PREPARATION FOR LAUNDERING (CHILD LOCK)

To avoid programme flow from being affected if programme buttons are pressed or programme button is turned when performing washing operation in your machine, child lock is available.

Child lock will be activated in case pressed on both auxiliary functions 3 and 4 at the same time for more than 3 seconds. You can see the auxiliary function leds on the display when activated.

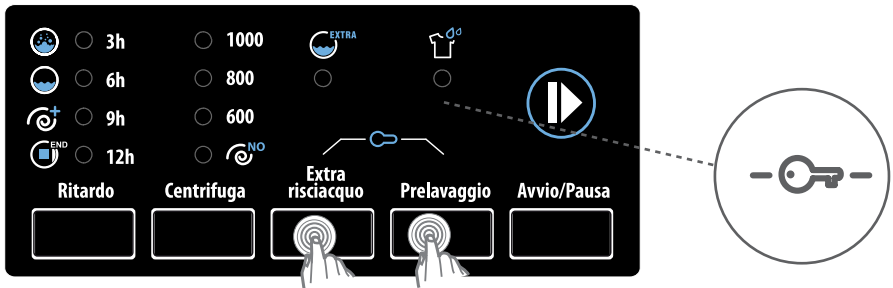

If pressed any button while child lock is active, the Additional Function Leds will blink on the display.

If while the child lock is engaged and any programme is running, the programme knob is switched to the CANCEL position and another programme is selected, the programme previously selected continues from where it left.

To deactivate it, it will be sufficient to press on the same buttons for more than 3 seconds. When the child lock is deactivated, the Additional Function Leds will blink on the display.

If you want to cancel any programme running:

- 1- Switch the programme knob to “CANCEL” position.
- 2- Your machine will stop the washing operation and the programme will be cancelled.
- 3- To get rid of the water accumulated in the machine switch the programme knob to any programme.
- 4- Your machine will perform the necessary discharge operation and cancel the programme.
- 5- You can run your machine by selecting a new programme.

CHAPTER-5: PRELIMINARY PREPARATION FOR LAUNDERING FINISHING PROGRAMME

Your machine will stop by itself as soon as the programme you have selected finishes.

- End led will blink on the display panel.

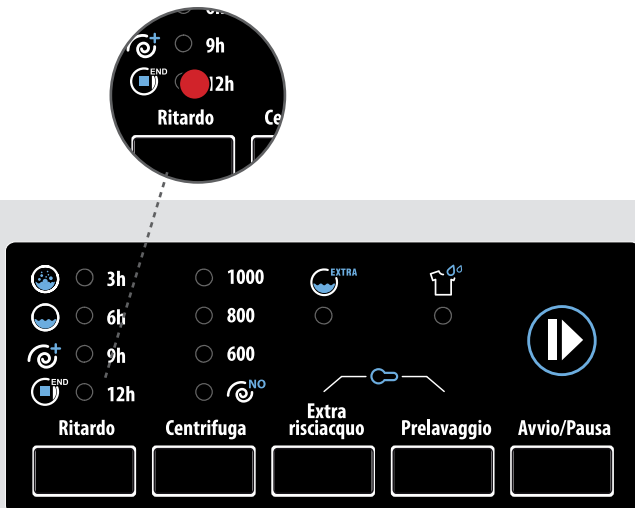

- You can open the machine's door and remove the laundry.

- Leave the door of your machine open to allow the inner part of your machine to dry after removing your laundries.

- Switch the programme knob to CANCEL position.

- Unplug your machine.

- Turn the water faucet off.

CHAPTER -6: PROGRAM TABLE

COTTON 90°

Washing temperature (°C)	90°
Maximum dry laundry amount (kg)	7,0
Detergent compartment	2
Programme duration (Min.)	200
Laundry type / Descriptions	Very dirty, cotton and flax textiles. (Underwears, linen, tablecloth, towel (maximum 3,5 kg), bedclothes, etc.

Pre-Wash Cotton

Washing temperature (°C)	60°
Maximum dry laundry amount (kg)	7,0
Detergent compartment	1&2
Programme duration (Min.)	165
Laundry type / Descriptions	Dirty cotton and flax textiles. (Underwears, linen, tablecloth, towel (maximum 3,5 kg), bedclothes, etc.

NOTE: PROGRAM DURATION MIGHT CHANGE ACCORDING TO THE AMOUNT OF LAUNDRY, TAP WATER, AMBIENT TEMPERATURE AND SELECTED ADDITIONAL FUNCTIONS.

CHAPTER -6: PROGRAM TABLE

COTTON ECO

60 C°

Washing temperature (°C)	60°
Maximum dry laundry amount (kg)	7,0
Detergent compartment	2
Programme duration (Min.)	205
Laundry type / Descriptions	Dirty cotton and flax textiles. (Underwears, linen, tablecloth, towel (maximum 3,5 kg), bedclothes, etc.

COTTON

40 C°

Washing temperature (°C)	40°
Maximum dry laundry amount (kg)	7,0
Detergent compartment	2
Programme duration (Min.)	195
Laundry type / Descriptions	Dirty cotton and flax textiles. (Underwears, linen, tablecloth, towel (maximum 3,5 kg), bedclothes, etc.

NOTE: PROGRAM DURATION MIGHT CHANGE ACCORDING TO THE AMOUNT OF LAUNDRY, TAP WATER, AMBIENT TEMPERATURE AND SELECTED ADDITIONAL FUNCTIONS.

CHAPTER -6: PROGRAM TABLE

ECO 20°

Washing temperature (°C)	20°
Maximum dry laundry amount (kg)	3,5
Detergent compartment	2
Programme duration (Min.)	98
Laundry type / Descriptions	Less dirty, cotton and linen textiles. (Underwear, bedsheet, tablecloth, towel (max. 2,0 kg) bedcloth, etc.

EASY CARE

Washing temperature (°C)	40°
Maximum dry laundry amount (kg)	3,5
Detergent compartment	2
Programme duration (Min.)	89
Laundry type / Descriptions	Very dirty or synthetic-mixed textiles. (Nylon socks, shirts, blouses, synthetic-including trousers etc.)

NOTE: PROGRAM DURATION MIGHT CHANGE ACCORDING TO THE AMOUNT OF LAUNDRY, TAP WATER, AMBIENT TEMPERATURE AND SELECTED ADDITIONAL FUNCTIONS.

WOOL

Washing temperature (°C)	30°
Maximum dry laundry amount (kg)	2,5
Detergent compartment	2
Programme duration (Min.)	40
Laundry type / Descriptions	Woollen laundries with machine wash labels.

RINSING

Washing temperature (°C)	-
Maximum dry laundry amount (kg)	7,0
Detergent compartment	-
Programme duration (Min.)	42
Laundry type / Descriptions	If you want to additionally rinse your laundries upon completion of washing operation, you may use this programme for any kind of laundries.

NOTE: PROGRAM DURATION MIGHT CHANGE ACCORDING TO THE AMOUNT OF LAUNDRY, TAP WATER, AMBIENT TEMPERATURE AND SELECTED ADDITIONAL FUNCTIONS.

CHAPTER -6: PROGRAM TABLE

SPINNING

Washing temperature (°C)	-
Maximum dry laundry amount (kg)	7,0
Detergent compartment	-
Programme duration (Min.)	17
Laundry type / Descriptions	If you want to additionally Spinning your laundries upon completion of washing operation, you may use this programme for any kind of laundries.

SENSITIVE/HAND WASH

Washing temperature (°C)	30°
Maximum dry laundry amount (kg)	2,5
Detergent compartment	2
Programme duration (Min.)	100
Laundry type / Descriptions	Laundry recommended for hand wash or sensitive laundry.

NOTE: PROGRAM DURATION MIGHT CHANGE ACCORDING TO THE AMOUNT OF LAUNDRY, TAP WATER, AMBIENT TEMPERATURE AND SELECTED ADDITIONAL FUNCTIONS.

CHAPTER -6: PROGRAM TABLE

SPORTS WEAR

Washing temperature (°C)	30°
Maximum dry laundry amount (kg)	3,5
Detergent compartment	2
Programme duration (Min.)	79
Laundry type / Descriptions	Sportswear.

MIXED

Washing temperature (°C)	30°
Maximum dry laundry amount (kg)	3,5
Detergent compartment	2
Programme duration (Min.)	85
Laundry type / Descriptions	Dirty cotton, synthetics, colour and flax textiles can be washed together.

NOTE: PROGRAM DURATION MIGHT CHANGE ACCORDING TO THE AMOUNT OF LAUNDRY, TAP WATER, AMBIENT TEMPERATURE AND SELECTED ADDITIONAL FUNCTIONS.

BLOUSES / SHIRTS

Washing temperature (°C)	60°
Maximum dry laundry amount (kg)	3,5
Detergent compartment	2
Programme duration (Min.)	110
Laundry type / Descriptions	Dirty cotton, synthetic and synthetic-mixed shirts and blouses can be washed together.

DAILY 60 min.

Washing temperature (°C)	60°
Maximum dry laundry amount (kg)	3,0
Detergent compartment	2
Programme duration (Min.)	60
Laundry type / Descriptions	You can wash your dirty cotton, colour and flax textiles at 60°C in 60 minutes.

If you have the rapid washing auxiliary function in your machine, then if you put 2 kg or less laundry in your machine, your machine will automatically wash for laundry for 30 minutes.

NOTE: PROGRAM DURATION MIGHT CHANGE ACCORDING TO THE AMOUNT OF LAUNDRY, TAP WATER, AMBIENT TEMPERATURE AND SELECTED ADDITIONAL FUNCTIONS.

RAPID 15 min.

Washing temperature (°C)	30°
Maximum dry laundry amount (kg)	2,0
Detergent compartment	2
Programme duration (Min.)	15
Laundry type / Descriptions	You can wash your slightly stained, cotton, colored and flax textile within only 15 minutes.

NOTE: As the washing period is short, less amount of detergent is required to be used compared to other programmes. The programme period will increase if your machine detects instable loading. You can open the door of your machine 2 minutes after the completion of washing operation. (The duration of 2 minutes required to open the door of your machine is not included in the washing period.)

NOTE: PROGRAM DURATION MIGHT CHANGE ACCORDING TO THE AMOUNT OF LAUNDRY, TAP WATER, AMBIENT TEMPERATURE AND SELECTED ADDITIONAL FUNCTIONS.

CHAPTER -7: MAINTENANCE AND CLEANING OF YOUR MACHINE (WARNING)



Unplug your machine before starting the maintenance and cleaning of your machine.

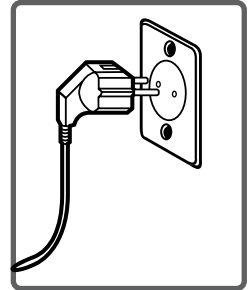

Turn the tap water off before starting the maintenance and cleaning of your machine.

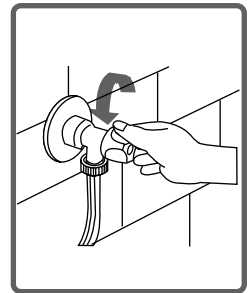

CAUTION: Your machine's parts might be damaged if cleaners with solvent agents are used.

Do not use cleaning materials with solvent agents.

CHAPTER -7: MAINTENANCE AND CLEANING OF YOUR MACHINE (WATER INLET FILTERS)

Filters to avoid dirt and foreign substances in the water from penetrating into the machine are available both on the side of faucet and on the ends of water valves along the water inlet hose of your machine.

If your machine cannot intake sufficient amount of water despite water faucet being open, these filters should be cleaned.

(It is recommended that you clean your pump filter once in 2 months.)

- Detach the water inlet hoses.
- Remove the filters on water inlet valves using pliers and then clean it with a brush in water.
- Disassemble the filters on the side of faucet side of water inlet hoses manually and clean it.
- Having the filters cleaned, you can fit them in the same way reversely.

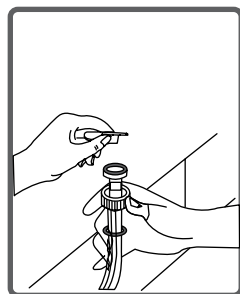
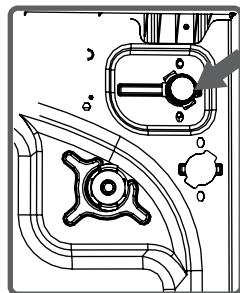

CAUTION:

Filters of water inlet valves may be clogged due to contaminated water faucet or lack of necessary maintenance or valves may be broken down, causing water leaking into your machine continuously.



The breakdowns that may arise due to these reasons are out of the scope of warranty.

CHAPTER -7: MAINTENANCE AND CLEANING OF YOUR MACHINE (PUMP FILTER)

A filter system which avoids threads remaining from your laundries and tiny materials from entering into the pump during water discharging operation carried out by your machine after completing washing so prolonging the lifecycle of your pump is available. It is recommended that you clean your pump filter once in 2 months. To clean pump filter:

- To open the pump cover, you can use the powder detergent spade (*) or liquid detergent level plate coming out of your machine.

- Fit the end point of the plastic part to the gap of the pump cover and push it back. This will open the cover.

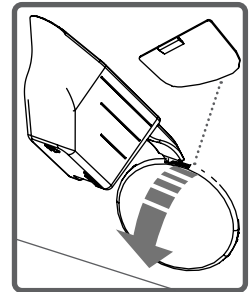

- Before opening the filter cover, settle a vessel in front of the filter cover to prevent the water remained in the machine from flowing on the ground.

- Loosen the filter cover in counter-clockwise and then empty water.

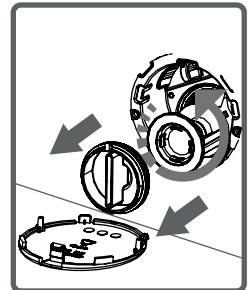

Note: You may have to empty the water collection vessel several times according to the amount of water in the machine.

(*) Machinery specifications may vary depending on the product purchased.

CHAPTER -7: MAINTENANCE AND CLEANING OF YOUR MACHINE (PUMP FILTER)

- Clean the foreign materials in the filter with a brush.

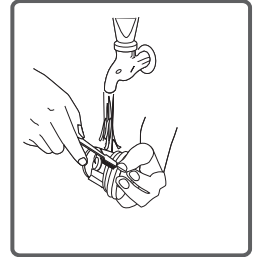

- After cleaning the filter, fit the filter cover and tighten it by rotating it in clockwise direction.

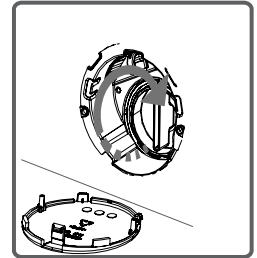

- While closing the pump cover, ensure that the parts on the inner side of the cover to match the holes on the front panel side.

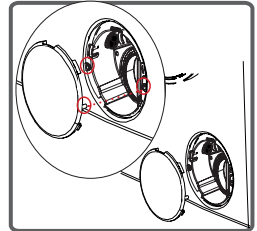

- You can reattach the pump cover in the reverse order that you removed it.

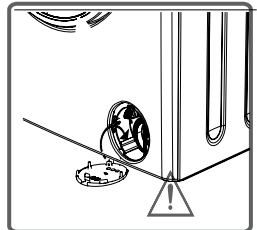

WARNING!

As water in the pump may be hot, wait until it cools down.

CHAPTER -7: MAINTENANCE AND CLEANING OF YOUR MACHINE (DETERGENT DRAWER)

Your detergents may deposit residue in detergent drawer and housing of detergent drawer over time.

To clean the residue formed, disassemble the detergent drawer in particular periods. It is recommended that you clean your pump filter every 2 months.

To eject the detergent drawer:

- Pull the detergent drawer up to the end
- Keep on pulling by depressing on the section shown below in the detergent drawer and keep pulling and then unsettle the detergent drawer.

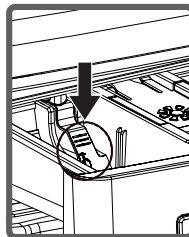
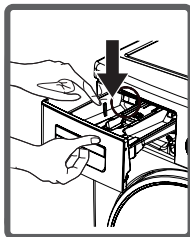
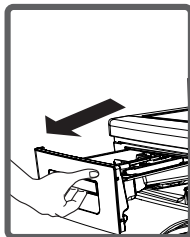

- Flusuh it using a brush.
- Collect residues in the housing of the detergent drawer without dropping them inside the machine.
- Assemble the detergent drawer after drying it using a towel or dry cloth.
- Do not wash your detergent drawer in dishwasher.



Liquid Detergent Apparatus (*)

Take out the liquid detergent level apparatus for cleaning and maintenance purposes as shown in the picture and clean well detergent residues. Put the apparatus back into its place. Make sure no residues are left inside.

(*) Machinery specifications may vary depending on the product purchased.

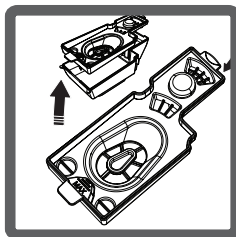
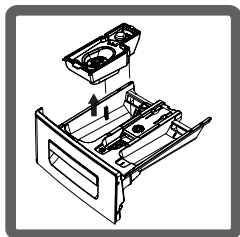

Flush stopper

Disassemble the detergent drawer. Disassemble the flush stopper and clean the softener residues completely. Refit the flush stopper after cleaning it. Check whether it has settled properly.

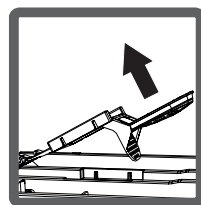
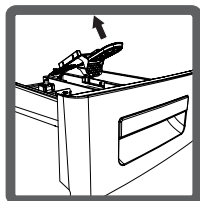
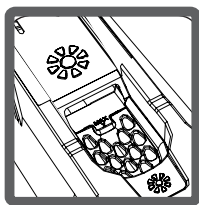

Body

Clean the outer body of your machine with warm water and a non-inflammable cleaning agent that will not abrade the body of your machine. After rinsing with some water, dry it using a soft and dry cloth.

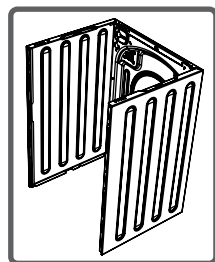

Drum

Do not leave metallic objects such as needles, paper clips, coins etc. in your machine. This objects lead to formation of rust stains in the drum. To clean such rust stains, use a non-chlorine cleaning agent and follow the instructions of manufacturers of the cleaning agent. Never use wire wool or similar hard objects for cleaning rust stains.

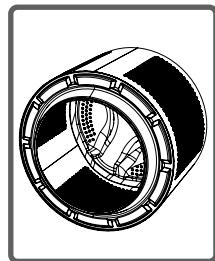

CHAPTER -9: TROUBLESHOOTING

All repairing operations required for your machine should be carried out by our authorised service. If your machine requires a repair or if you cannot remove the fault by the help of the information provided as follows:

- Unplug your machine.
- Turn the water faucet off.

FAULT	POSSIBLE CAUSE	TROUBLESHOOTING
Your machine does not start.	It is not plugged.	Plug machine in.
	Fuses out of order.	Replace the fuses.
	Electricity cut-off.	Check mains power.
	Start/Pause button not pressed.	Press on Start/Pause button.
	Programme dial 'stop' position.	Switch the programme button to the desired position.
	The machine door is not completely closed.	Close the machine door.
Your machine does not intake water.	Water tap is turned off.	Turn your faucet on.
	Water inlet hose may be twisted.	Check water inlet hose and untwist.
	Water inlet hose clogged.	Clean water inlet hose filters. (*)
	Valve inlet filter clogged.	Clean the valve inlet filters. (*)
	The machine door not completely closed.	Close the machine door.

(*) See the chapter regarding maintenance and cleaning of your machine.

FAULT	POSSIBLE CAUSE	TROUBLESHOOTING
Your machine does not discharge water.	Discharging hose clogged or twisted.	Check the discharging hose, then either clean or untwist.
	Pump filter clogged.	Clean the pump filter. (*)
	Laundries settled in the machine non-homogeneously.	Spread your laundry in the machine evenly.
Your machine vibrates.	The feet of your machine have not been adjusted.	Adjust the feet on your machine. (**)
	Safety stays fitted for transportation not disassembled.	Disassemble the safety stays of your machine. (**)
	Less amount of laundry in the appliance.	This will not block operation of your machine.
	Your machine is overloaded with laundry or laundry settled unevenly.	Do not put in laundry more than the amount recommended and settle the laundry in the machine evenly
	Your machine rests on a hard surface.	Prevent your machine from resting on hard surfaces.

(*) See the chapter regarding maintenance and cleaning of your machine.

(**) See the chapter regarding installation of your machine.

FAULT	POSSIBLE CAUSE	TROUBLE-SHOOTING
<p>Excessive foam is formed in the detergent drawer.</p>	<p>Excessive amount of detergent used.</p>	<p>Press on Start/Pause button. To eliminate foam formation, mix a spoon of softener with half litres of water, and pour the mixture in the detergent drawer. After 5-10 minutes, Press on Start/Pause button again. In your next washing operation, Adjust the detergent dose accordingly.</p>
	<p>Wrong detergent used.</p>	<p>Use detergents produced only for automatic washing machines in your machine.</p>
<p>Unsatisfactory washing result.</p>	<p>The contamination degree of your laundries does not match the programme you have chosen.</p>	<p>Select the programme appropriate for the contamination degree of your laundries. (See programme table)</p>
	<p>Amount of detergent used insufficient.</p>	<p>Adjust the amount of detergent based on the amount and contamination degree of your laundries.</p>
	<p>Laundries in excess of maximum capacity put in your machine.</p>	<p>Load your machine with laundries, amount of which will not exceed maximum laundry capacity.</p>





FAULT	POSSIBLE CAUSE	TROUBLE-SHOOTING
Unsatisfactory washing result.	Water being hard. (Contaminated, lime water etc.)	Adjust the amount of detergent based on the instruction of detergent manufacturer.
	Laundries distributed in your machine non-homogenously.	Spread your laundries in the machine properly and homogeneously.
As soon as the machine is loaded with water, water discharges.	The end of water discharging hose is too low for the machine.	Set the water discharging hose on appropriate height. (**)
No water appears in the drum during washing.	No fault. Water is in the unseen part of the drum.	—————
Laundries have detergent residues on them.	Non-dissolving particles of some detergents may stick to your laundries as white spots.	Perform an Extra rinse by setting your machine to “Rinsing” programme, or clean the spots using a brush after your laundries dry.
Grey spots appear on the laundries.	The reason for such spots may be oil, cream or ointment.	Apply the maximum amount of detergent instructed by the detergent manufacturer in the next washing operation.

(**) See the chapter regarding installation of your machine.

FAULT	POSSIBLE CAUSE	TROUBLE-SHOOTING
<p>Spinning operation is not performed or runs late.</p>	<p>No fault. Unbalanced load control system has been activated.</p>	<p>Unbalanced load control system will try to spread your laundries homogeneously. Spinning operation will begin after your laundry is spread. Place the laundry in the machine in a balanced fashion the next time.</p>

CHAPTER -10: AUTOMATIC FAULT WARNINGS AND WHAT TO BE DONE

Your machine is equipped with the systems which are capable of both taking necessary precautions and warning you in case of any breakdown by means of continuous self-checking during washing operations.

TROUBLE CODE	POSSIBLE FAULT	WHAT TO DO
E01 	The door of your machine is left open.	Close the machine door. If your machine persists to indicate fault, turn off your machine, unplug it and contact the nearest authorised service immediately.
E02 	The water pressure or the water level inside the machine is low.	Turn on the faucet. Mains water may be cut-off. If the problem still continues, your machine will stop after a while automatically. Unplug the machine, turn off your faucet and contact the nearest authorised service.
E03 	The pump is faulty or pump filter is clogged or electrical connection of the pump is faulty.	Clean the pump filter. If the problem persists, contact the nearest authorised service. (*)
E04 	Your machine has excessive amount of water.	Your machine will discharge water by itself. Pursuant to discharging operation, turn off your machine and unplug it. Turn off your faucet and contact the nearest authorised service.

(*) See the chapter regarding maintenance and cleaning of your machine.

Alcoholic drinks: Spotted area should initially be washed using cold water, and then be wiped with glycerine and water and rinsed with vinegar-mixed water.

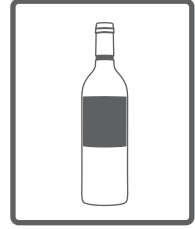

Shoe shine: Spot should be rubbed out gently without damaging the cloth and be scrubbed and rinsed with detergent. If not removed, it should be scrubbed using the mixture obtained by adding 1 scale of alcohol (96°) into 2 scales of water, and then be washed with warm water.

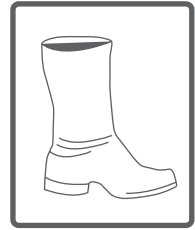

Tea and coffee: Stretch the spotted area of your laundry throughout the opening of a vessel, and pour hot water as much as the type of your laundry can resist. In case the type of your laundry permits, wash with bleach-er.



Chocolate and cocoa: After submerging your laundries in cold water and rubbing it using soap or detergent, wash it in temperature that fabric type of your laundry can resist. In case the oil stain is still visible, wipe with oxygen water (3%).



Tomato paste: After rubbing out the dried substances without damaging your laundry, submerge it in water for 30 minutes, and then scrub and wash it with detergent.

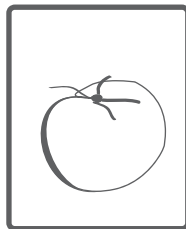

Bouillon-Egg: Remove dried spot residues on your laundry, and then wipe it with a sponge or soft cloth submerged in cold water previously. Scrub with detergent, wash with diluted bleach.

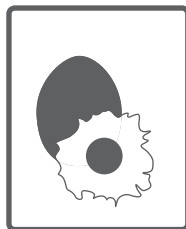

Grease and oil stains: Firstly, wipe the residues. Scrub the spot with detergent and wash it with warm soapy water.



Mustard: Apply glycerine on spotted area. Scrub with detergent and wash. If the spot cannot be removed, wipe with alcohol. (For synthetic and colour fabrics, a mixture of 1 scale of alcohol and 2 scales of water should be used)

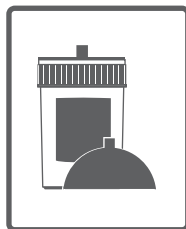

Fruit: Stretch the spotted area of your laundry throughout the opening of a vessel, and pour cold water on it. Do not pour hot water on the spot. Wipe with cold water and apply glycerine. Allow 1-2 hours, wipe with a few drops of white vinegar, and rinse it.

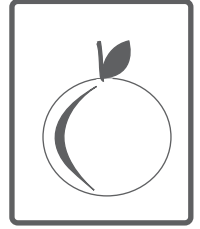

Grass stain: Wipe the stained part with detergent. If the type of your cloth permits bleach using, wash with bleach. Wipe your woollen laundries with alcohol. (For colour fabrics, a mixture of 1 scale of pure alcohol and 2 scales of water)

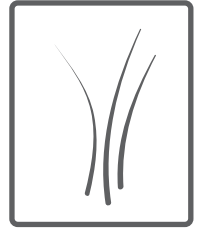

Oil paint: Spot should be removed by applying thinner before drying. Then it should be wiped with detergent and washed.

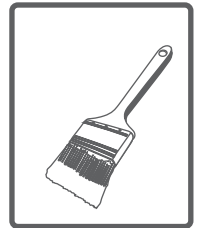

Burn stain: If your laundry is suitable for applying bleach-er, you can add bleach into washing water. For wool fabric, a cloth previously submerged in oxygen water should be covered over the stain and it should be ironed after putting a dry cloth on this cloth. It should be washed after being rinsed properly.



Blood stain: Submerge your laundries in cold water for 30 minutes. If the stain is not removed, then submerge in a mixture of water and ammoniac (3 spoons of ammoniac in 4 litres of water) for 30 minutes.

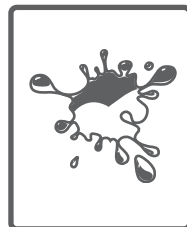

Crema, ice cream and milk: Submerge your laundries in cold water and scrub the spotted area with detergent. If the spot is not removed, apply bleacher to the extent suitable for your laundries. (Do not use bleacher for colour laundries.)



Muff: Muff stains should be cleaned as soon as possible. Stain should be washed with detergent water, nevertheless if it cannot be removed, it should be wiped with oxygen water (3%).

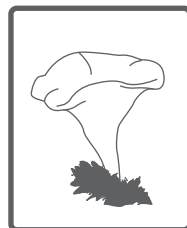

Ink: Subject the spotted area to running water and wait until the flow of inked water ends. Then wipe it with lemon-added water and detergent, and wash it after allowing 5 minutes.

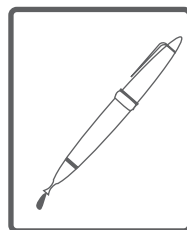

DESCRIBING ENERGY LABEL AND SAVING ENERGY

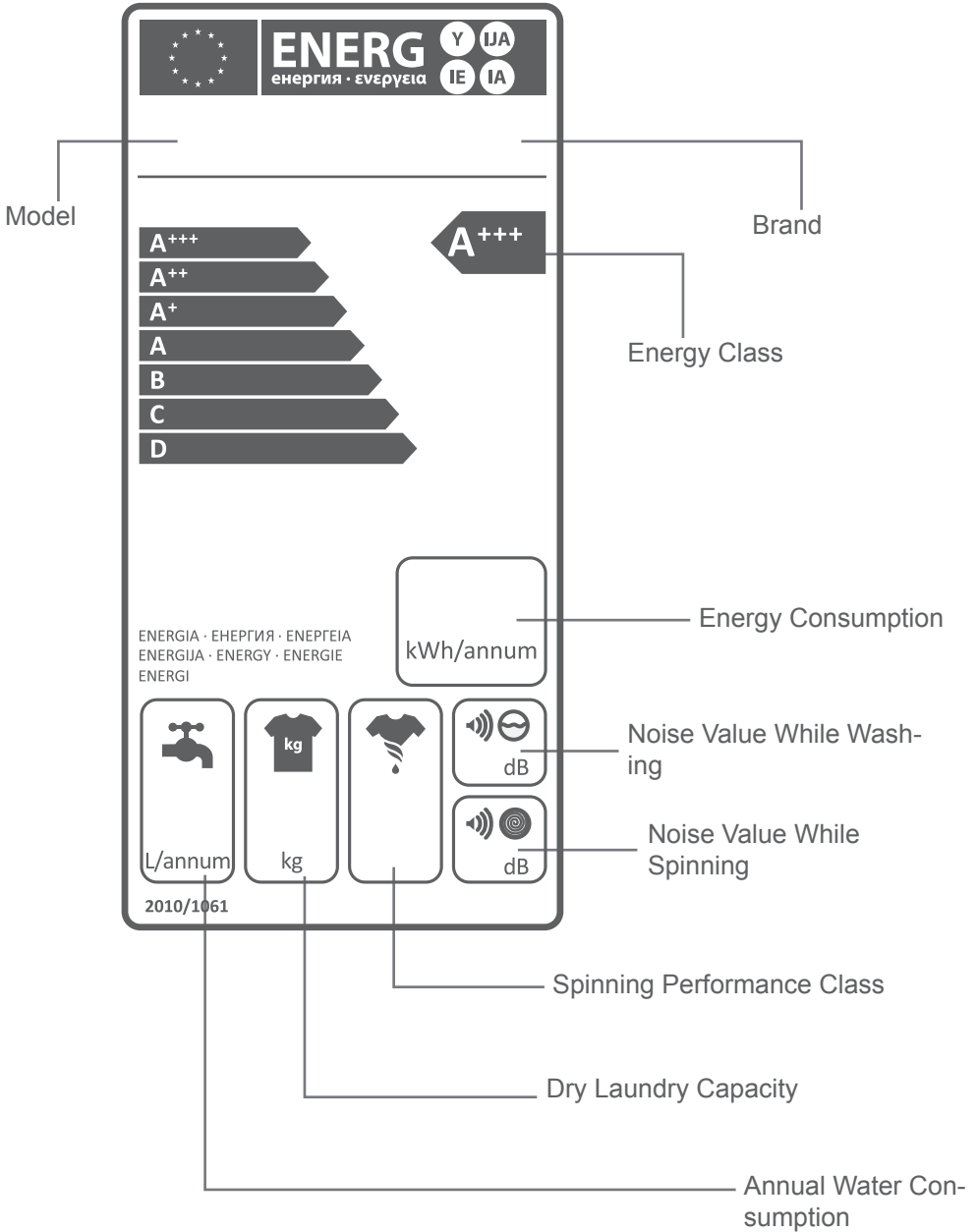

DESCRIBING ENERGY LABEL AND SAVING ENERGY

Energy and water consumption may vary based on water pressure, water hardness, water temperature, ambient temperature, laundry amount, additional function selection, voltage fluctuations. It will reduce energy and water consumption to use your machine with the laundry capacity proposed for the selected programme, wash your laundries less dirty or daily laundries in short programmes, carry out cleaning and maintenance periodically, use your machine in convenient time intervals specified by electricity vendor.

DISPOSAL OF YOUR OLD MACHINE

This symbol on the product or package implies that the product should not be treated as domestic waste. Instead, it should be delivered to applicable waste collection places recycling electrical and electronic equipment.

You will contribute to avoid potential negative results regarding environment and human health, which will arise due to wrong waste procedure for the product by ensuring that this product is annihilated properly.

Recycling materials will help natural resources be preserved.

For more detailed information regarding recycling of this product, please contact local municipality, domestic waste annihilation service or the shop you have purchased the product.



PAGE LEFT BLANK INTENTIONALLY

