

F:\56216\_EN\SONY\CX49400\_IM\_GB\4734285211\4734285211FDR  
AX434560GB\00COV\010COV.fm  
master:Right

**SONY**

4-734-285-22(1)

## Digital 4K Video Camera Recorder

### Operating Instructions



#### "Help Guide" (Web manual)

Refer to "Help Guide" for in-depth instructions on the many functions of the camera.

[http://rd1.sony.net/help/cam/1720/h\\_zz/](http://rd1.sony.net/help/cam/1720/h_zz/)

Getting started	
Recording/Playback	
Saving images	
Customizing your camcorder	
Others	

**HANDYCAM**



FDR-AX43/AX45/AX60

FDR-AX43/AX45/AX60  
4-734-285-22(1)



## Utilizing the Help Guide

The Help Guide is an online manual which you can see on your computer or smartphone. Refer to it for the detailed menu and how to use it, or the latest information.



[http://rd1.sony.net/help/cam/1720/h\\_zz/](http://rd1.sony.net/help/cam/1720/h_zz/)

You will find further information such as the following functions in Help Guide.

- Time-lapse Capture
- TC/UB (Time Code/User Bit)
- Highlight Movie Maker
- Multi Camera Control
- Trimming Playback

## Table of Contents

Selecting recording format/ image quality .....	4
<b>Getting started .....</b>	<b>7</b>
Supplied items .....	7
Charging the battery pack .....	8
Turning the power on .....	11
Inserting a memory card .....	12
<b>Recording/Playback ...</b>	<b>15</b>
Recording .....	15
Using the manual adjustment features .....	18
Playback .....	19
Creating highlight movies .....	22
Viewing images on a TV .....	23
<b>Saving images .....</b>	<b>27</b>
Importing images to your computer .....	27
Saving images on an external media device .....	28
Using the Wi-Fi function .....	30
<b>Customizing your camcorder .....</b>	<b>34</b>
Using the menus .....	34
<b>Others .....</b>	<b>37</b>
Precautions .....	37
Specifications .....	40
Parts and controls .....	44
Index .....	47

# Selecting recording format/image quality



- 1** Select **[MENU]** → [Image Quality/Size] → [**FILE** File Format] → desired setting value.

File format	Features	
XAVC S 4K	Allows recording with 4K resolution (3,840 × 2,160)	Data can be saved in the computer using the PlayMemories Home™ software.
XAVC S HD	Information volume is greater compared to AVCHD, enabling recording of clearer images.	
AVCHD	Compatibility with recording devices other than computers is good.	

For supporting memory cards with each format, see page 12.

- 2** Select **[MENU]** → [Image Quality/Size] → [**REC** REC Mode] → desired setting value.



- Setting with a higher bit-rate makes image quality higher.
- Refer to the Help Guide for details of the following:
  - High Speed REC
  - Estimated maximum recording time of each recording format

[ File Format] is [ XAVC S 4K]

 REC Mode	Frame rate	Bit-rate	Actual movie format
60Mbps <u>60</u>	30p <sup>*1</sup> /25p <sup>*2</sup>	Max. 60 Mbps	3,840 × 2,160 (30p/25p)
	24p <sup>*1</sup>	Max. 60 Mbps	3,840 × 2,160 (24p)
100Mbps <u>100</u>	30p <sup>*1</sup> /25p <sup>*2</sup>	Max. 100 Mbps	3,840 × 2,160 (30p/25p)
	24p <sup>*1</sup>	Max. 100 Mbps	3,840 × 2,160 (24p)

<sup>\*1</sup> 1080 60i-compatible device

<sup>\*2</sup> 1080 50i-compatible device

[ File Format] is [ XAVC S HD]

 REC Mode	Frame rate	Bit-rate	Actual movie format
50Mbps <u>50</u>	60p <sup>*1</sup> /50p <sup>*2</sup>	Approx. 50 Mbps	1,920 × 1,080 (60p/50p)
	30p <sup>*1</sup> /25p <sup>*2</sup>	Approx. 50 Mbps	1,920 × 1,080 (30p/25p)
	24p <sup>*1</sup>	Approx. 50 Mbps	1,920 × 1,080 (24p)
100Mbps <u>100</u> <sup>*3</sup>	120p <sup>*1</sup> / 100p <sup>*2</sup>	Approx. 100 Mbps	1,920 × 1,080 (120p/100p)
60Mbps <u>60</u> <sup>*3</sup>	120p <sup>*1</sup> / 100p <sup>*2</sup>	Approx. 60 Mbps	1,920 × 1,080 (120p/100p)

<sup>\*1</sup> 1080 60i-compatible device

<sup>\*2</sup> 1080 50i-compatible device

<sup>\*3</sup> Only when [High Speed REC] is selected for [Shooting Mode].

## [ File Format] is [ AVCHD]

 REC Mode <sup>*1</sup>	Frame rate	Bit-rate	Actual movie format
Highest Quality <b><u>FX</u></b>	60i <sup>*2</sup> /50i <sup>*3</sup>	Max. 24 Mbps	1,920 × 1,080 (60i/50i)
	24p <sup>*2</sup> /25p <sup>*3</sup>	Max. 24 Mbps	1,920 × 1,080 (24p/25p)
High Quality <b><u>FH</u></b>	60i <sup>*2</sup> /50i <sup>*3</sup>	Avg. 17 Mbps	1,920 × 1,080 (60i/50i)
	24p <sup>*2</sup> /25p <sup>*3</sup>	Avg. 17 Mbps	1,920 × 1,080 (24p/25p)
Standard <b><u>HQ</u></b>	60i <sup>*2</sup> /50i <sup>*3</sup>	Avg. 9 Mbps	1,440 × 1,080 (60i/50i)
Long Time <b><u>LP</u></b>	60i <sup>*2</sup> /50i <sup>*3</sup>	Avg. 5 Mbps	1,440 × 1,080 (60i/50i)
60p Quality <b><u>PS</u></b> / 50p Quality <b><u>PS</u></b>	60p <sup>*2</sup> /50p <sup>*3</sup>	Max.28 Mbps	1,920 × 1,080 (60p/50p)

<sup>\*1</sup> When you create an AVCHD disc from movies recorded with the [ REC Mode] setting of [Highest Quality **FX**] or [60p Quality **PS**]/[50p Quality **PS**], it will take a long time to change the image quality.

<sup>\*2</sup> 1080 60i-compatible device

<sup>\*3</sup> 1080 50i-compatible device

## | To transfer images to a smartphone

You can transfer MP4 images to a smartphone connected to the camcorder via Wi-Fi (page 30). MP4 format is good for uploading to the Internet. When [Dual Video REC] is set to [On], the camcorder records MP4 movies while recording "XAVC S 4K movies", "XAVC S HD movies" or "AVCHD movies" at the same time.

### Notes

- [On] is set for the default value of [Dual Video REC].

# Supplied items

The numbers in ( ) indicate the supplied quantity.

## All models

- Camcorder (1)
- AC Adaptor (1)

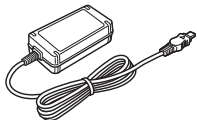

- Power cord (mains lead) (1)

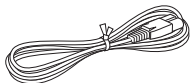

- Micro USB cable (1)

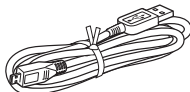

- HDMI cable (1)



- "Operating Guide" (This manual) (1)
- Rechargeable battery pack NP-FV70A (1)



# Charging the battery pack

- 1 Turn off your camcorder by closing the LCD monitor, retract the viewfinder\*, and attach the battery pack.

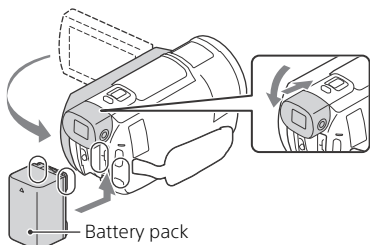

\* Models with the viewfinder (FDR-AX60) only

- 2 Connect the AC Adaptor and the power cord (mains lead) to your camcorder and the wall outlet (wall socket).

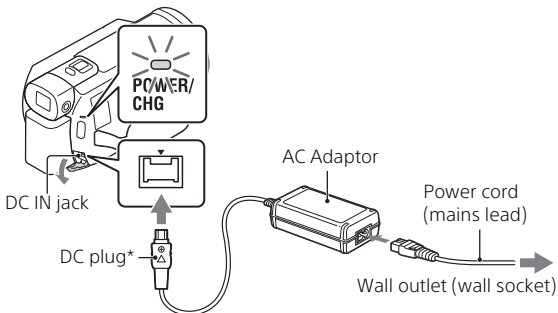

- \* Align the ▲ mark on the DC plug with that on the DC IN jack.
- The POWER/CHG (charge) lamp turns orange.
- The POWER/CHG (charge) lamp turns off when the battery pack is fully charged. Disconnect the AC Adaptor from the DC IN jack of the camcorder.



## | Charging the battery using your computer

Turn off your camcorder and connect the Multi/Micro USB Terminal of the camcorder (page 44) to the USB jack of a computer using the micro USB cable.

- Change the setting of your computer so that it would not enter the sleep (hibernation) state before charging your camcorder.

## | Estimated time of charging the supplied battery pack (minutes)

Battery pack	AC Adaptor (supplied)	Computer
NP-FV70A	190	535

- The charging times are measured when charging an empty battery pack to its full capacity at a room temperature of 25 °C (77 °F).

## | Estimated time of recording and playback using the supplied battery pack (minutes)

Battery pack	Recording time		Playback time
	Continuous	Typical	
NP-FV70A	160	80	280

- The recording and playback times are measured when using the camcorder at 25 °C (77 °F).
- The recording times are measured when recording movies with the default settings ([**File Format**]: [**4K**] XAVC S 4K, [**REC Mode**]: [60Mbps **60** ], [Dual Video REC]: [On]).
- Typical recording time shows the time when you repeat recording start/stop, switching the [Shooting Mode], and zooming.
- The recording time shows the time when recording with the LCD monitor open.

## | To use your camcorder connected to the wall outlet (wall socket)

The camcorder runs without consuming the battery while it is connected to the AC adaptor. However, the battery is not charged while the camcorder is turned on.

## | To remove the battery pack

Turn off your camcorder. Slide the BATT (battery) release lever (①) and remove the battery pack (②).

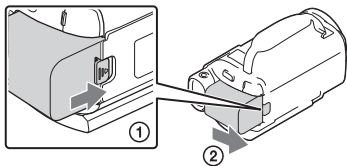

### Notes

- Remove the battery pack after waiting 15 seconds or more when turning the power off. If not, the camera setting may not be retained.

## | To charge the battery pack abroad

You can charge the battery pack in any countries/regions using the AC Adaptor supplied with your camcorder within the AC 100 V - 240 V, 50 Hz/60 Hz range.

- Do not use an electronic voltage transformer.

# Turning the power on

- 1 Open the LCD monitor of your camcorder and turn the power on.

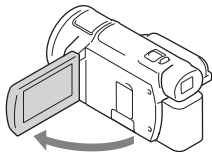

- You can also turn on the camcorder by pulling out the viewfinder (models with the viewfinder (FDR-AX60) only).

- 2 Following the instructions on the LCD monitor, select the language, the geographical area, Daylight Savings or Summer Time, date format, and the date and time.

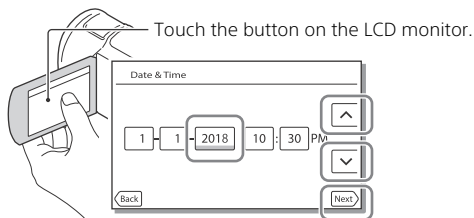

- To go to the next page, touch [Next].
- 
- To turn off the power, close the LCD monitor. If the viewfinder is pulled out, retract it (models with the viewfinder (FDR-AX60) only).
  - To set the date and time again, select **MENU** → [Setup] → [🕒 Clock Settings] → [Date & Time Setting]. (In case you haven't used your camcorder for several months)
  - To turn off the operating sound, select **MENU** → [Setup] → [🔧 General Settings] → [Beep] → [Off].

# Inserting a memory card

- 1 Open the cover, and insert the memory card until it clicks.

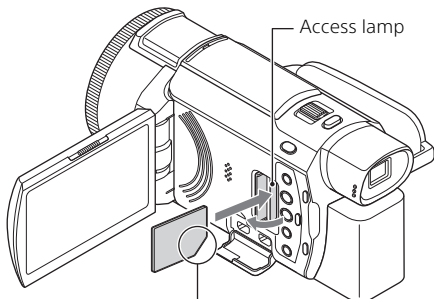

Insert the card with the notched corner in the direction as illustrated.

- The [Preparing image database file. Please wait.] screen appears if you insert a new memory card. Wait until the screen disappears.
- To select a memory card as the recording medium, select **[MENU]** → [Setup] → [Media Settings] → [Media Select] → [Memory Card] (FDR-AX45/AX60).
- To eject the memory card, open the cover and lightly push the memory card in once.

## Types of memory card you can use with your camcorder

Select the type of memory card to use with the camcorder referring to the following table.

### SD cards

Recording formats	Supporting memory cards
Photos	SD/SDHC/SDXC memory card, microSD/microSDHC/microSDXC memory card

Recording formats		Supporting memory cards
AVCHD		SD/SDHC/SDXC memory card, microSD/microSDHC/microSDXC memory card (Class 4 or faster, or U1 or faster.)
XAVC S	4K 60 Mbps* HD 60 Mbps (when recording with High Speed REC)* HD 50 Mbps*	SDHC/SDXC memory card, microSDHC/microSDXC memory card (Class 10 or faster, or U1 or faster.)
	4K 100 Mbps* HD 100 Mbps (when recording with High Speed REC)*	SDHC/SDXC memory card, microSDHC/microSDXC memory card (U3)

\* Including when recording with Dual Video REC.

## Memory Stick media

Recording formats		Supporting memory cards
Photos		Memory Stick PRO Duo™ media, Memory Stick PRO-HG Duo™ media, Memory Stick Micro™ (M2) media
AVCHD		Memory Stick PRO Duo (Mark 2) media, Memory Stick PRO-HG Duo media, Memory Stick Micro (M2) media
XAVC S		—

### Notes

- The movies recorded will be divided into files of 4 GB when a SDHC memory card is used to record XAVC S movies over extended periods of time.  
The divided files will be played back continuously when played back on the camcorder.  
The divided files can be integrated into the single file by using PlayMemories Home.
- Proper operation with all memory cards is not guaranteed. Contact the manufacturer of each memory card for the compatibility of memory cards other than Sony.

- When using a Memory Stick Micro or microSD memory card with the camcorder, be sure to use it by inserting it into the dedicated adaptor.
  - To repair or format the image database file, charge the battery pack fully in advance.
  - Movies saved on SDXC memory cards cannot be imported to or played back on computers or AV devices not supporting the exFAT(\*) file system by connecting this product to these devices with the micro USB cable. Confirm in advance that the connecting equipment is supporting the exFAT system. If you connect equipment not supporting the exFAT system and a message that prompts you to perform formatting appears, do not perform the formatting. All the data saved will be lost.
- \* The exFAT is a file system that is used for SDXC memory cards.

## | To format the recording media

- To ensure stable operation of the memory card, it is recommended to format the memory card with your camcorder before the first use.
- To format the memory card, select **MENU** → [Setup] → [Media Settings] → [Format] → desired recording medium → **OK** .
- Formatting the memory card will erase all the data stored on it and the data will be irrecoverable. Save your important data on your PC, etc.

# Recording

## Recording movies

- 1 Open the LCD monitor, and press START/STOP to start recording.

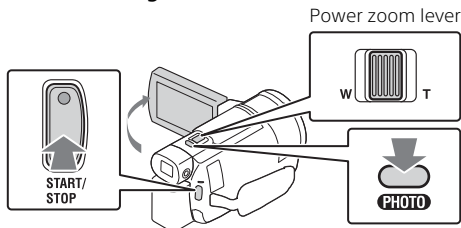

- To stop recording, press START/STOP again.
- Items on the LCD monitor disappear if you do not operate the camcorder for a few seconds. To display items again, touch anywhere except the buttons on the LCD monitor.

### Notes

- While recording movies in the XAVC S 4K 100Mbps or XAVC S 4K 60Mbps format, video signals (HDMI output signal/AV cable output signal) are not output to external media.

## To record MP4 movies simultaneously (Dual Video REC)

When [Dual Video REC] is set to [On], the camcorder records MP4 movies while recording "XAVC S 4K movies", "XAVC S HD movies" or "AVCHD movies" at the same time.

- [On] is set for its default value.
- When you change the setting, select **MENU** → [Image Quality/Size] → [Dual Video REC] → desired setting.
- MP4 format is easy for playing back your movies on a smartphone, for uploading to a network, or for uploading to the Web.



### Notes

- Select [On] for [Dual Video REC] when you create a highlight movie with "Highlight Movie Maker."

## Recording photos during movie recording (Dual Capture)

You can record photos during movie recording by pressing PHOTO.

### Notes

- You may not be able to shoot photos depending on the setting in [  REC Mode ] and [  Frame Rate ].
- You cannot specify the storage destination (internal memory/memory card) of photos and movies separately (FDR-AX45/AX60).

## To suppress the voice of the person recording the movie (My Voice Canceling)



Select [MENU] → [Camera/Mic] → [  Microphone ] → [My Voice Canceling] (page 35). The voice of the person recording the movie will be suppressed.



## Approximate recording time available



Movie format	Internal memory* <sup>1</sup> (FDR-AX45/AX60)	Memory card* <sup>2</sup>
XAVC S 4K	2 h. 00 min.	64 GB: 2 h. 00 min.* <sup>3</sup>
XAVC S HD	2 h. 25 min.	64 GB: 2 h. 25 min.* <sup>4</sup>
AVCHD	6 h. 55 min.	64 GB: 6 h. 50 min.* <sup>5</sup>

\*<sup>1</sup> If you want to record up to the maximum recording time, you need to delete the demonstration movie on this product.

\*<sup>2</sup> When using a Sony memory card.

\*<sup>3</sup> When recording with using the default setting:  
[  File Format ]: [  XAVC S 4K ], [  REC Mode ]: [60Mbps **60** ], [Dual Video REC]: [On]

\*<sup>4</sup> Approximate recording time when recording with the following setting:  
[  File Format ]: [  XAVC S HD ], [  Frame Rate ]: [60p]

\*<sup>5</sup> Approximate recording time when recording with the following setting:  
[  File Format ]: [  AVCHD ], [  REC Mode ]: [High Quality **FH** ]





- The actual recording time or number of recordable photos is displayed on the LCD monitor during recording.

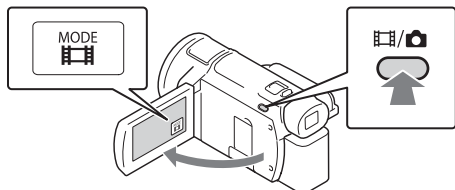

## Shooting photos

- 1 Open the LCD monitor and select [MODE] →  (Photo).



- You can also switch between  (Movie) and  (Photo) by pressing the / (Shooting Mode) button (FDR-AX60).

- 2 Press PHOTO lightly to adjust the focus, then press it fully.

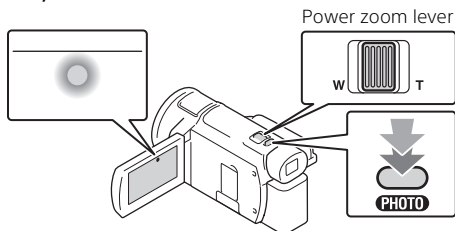

- When the focus is adjusted properly, AE/AF lock indicator appears on the LCD monitor.

# Using the manual adjustment features

## Assigning a menu item to the MANUAL ring (FDR-AX60)

- 1 Press and hold MANUAL button (page 45) for a few seconds.
  - The menu items you can control with the MANUAL ring will appear on the [Manual Ring Setting] screen.

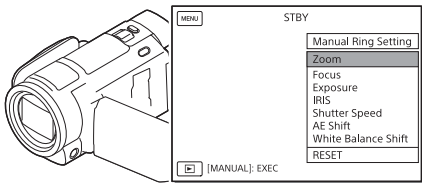

- 2 Rotate the MANUAL ring (page 45) to select the item to be assigned, and then press MANUAL button.

### Making the manual adjustment using the MANUAL ring



- ① Press the MANUAL button to switch to manual adjustment mode.
  - ② Rotate the MANUAL ring to make the adjustment.
- To return to automatic adjustment mode, press MANUAL button again.
  - When Zoom function is assigned, make the adjustment by only rotating the MANUAL ring.

# Playback

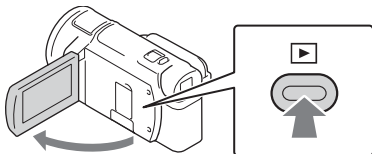
- 1 Open the LCD monitor and press the  (View Images) button on the camcorder to enter the playback mode.



- The Event View screen appears after some seconds.

- 2 Select  /  to move the desired event to the center, and then select the part circled (1) in the figure.

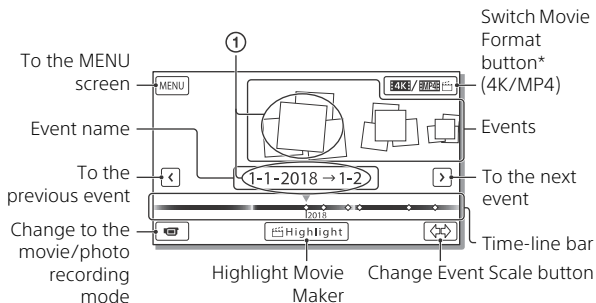

\* The icon varies depending on the  [File Format] setting (page 21).

- Photos and movies are stored in the same recording medium (internal memory/memory card) (FDR-AX45/AX60).
- To select the XAVC S movies or AVCHD movies you want to play, edit, or copy to other devices, select **MENU** → [Image Quality/Size] →  [File Format].
- You can play movies of the selected frame rate only in the case of XAVC S 4K movies. Select the frame rate according to the movies you want to play.

### 3 Select the image.

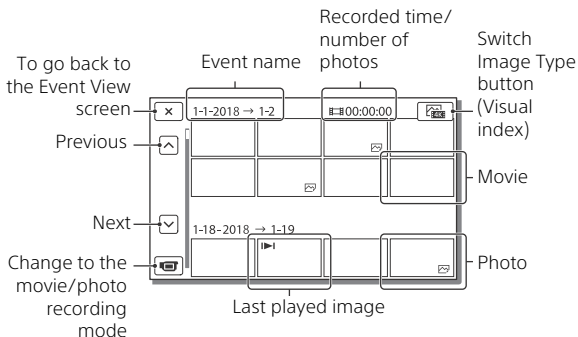

### To switch between movies and photos (Visual index)

Select the desired type of images.

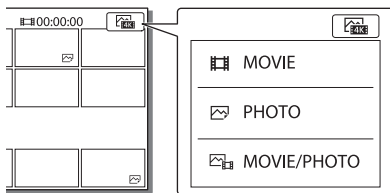

### Playback operations

	Volume	/	Previous/Next
	Delete	/	Fast-reverse/Fast-forward
	Context	/	Play/Pause
	Stop		Play/Stop slide show
	Motion Shot Video		Motion Interval ADJ

## I To delete the images

- ① Select **MENU** → [Image Quality/Size] → [File Format] → format of images to be deleted.
  - The available format varies depending on the [File Format] setting.
- ② Select **MENU** → [Edit/Copy] → [Delete] → [Multiple Images] → image type to be deleted.
- ③ Touch and display the ✓ mark on the images to be deleted, then select **OK**.

## I Switching to MP4

- ① Select “Switch Movie Format button.”

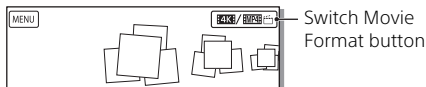

- The Movie Format Select screen appears.
- ② Select the format of the movie.

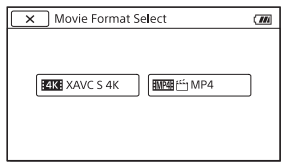

## I To copy the images from the internal memory to a memory card (FDR-AX45/AX60)

- ① Select **MENU** → [Edit/Copy] → [Copy] → [Int. Memory → Memory Card] → [Multiple Images].
- ② Select the image type to be copied.
- ③ Touch and display the ✓ mark on the images to be copied, then select **OK**.
- ④ Select **OK**.

### Notes

- XAVC S movies saved on the internal memory cannot be copied to SDHC memory cards or external media devices with the FAT file system.

# Creating highlight movies

Highlight Movie Maker is a function used to create highlight movies from MP4 format movies which have been recorded by Dual Video REC.

---

- 1 Press the  (create highlight movies) button (page 45).
- 2 On the LCD monitor, select an event you want to create a highlight movie and select  to display the confirmation screen.

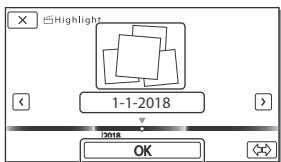

- 3 Select  on the confirmation screen to create a highlight movie.
    - To change the settings, select , change the settings according to your preference on the displayed setting screen, and then select .
-

# Viewing images on a TV

## Playing back images





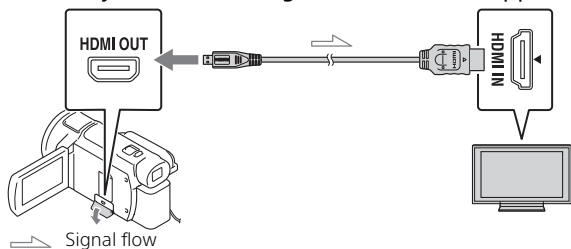







Playable images may be restricted depending on the combination of the movie format at the time of recording, the type of playback images selected on the Event View screen, and the HDMI output settings.

- 1 Connect the HDMI OUT jack of the camcorder to the HDMI IN jack of a TV using the HDMI cable supplied.



- 2 Set the input of TV to HDMI IN.
- 3 Play back images on the camcorder.

## How to set the playback images



Movie format	TV	[HDMI Resolution]	Visual index (page 20)	Playback image quality
XAVC S 4K	4K TV	[Auto], [2160p/1080p]	 MOVIE  PHOTO  MOVIE/ PHOTO	4K image quality
		[Auto], [1080p], [1080i], [720p]	 MOVIE  MOVIE/ PHOTO   PHOTO	High definition image quality (HD)
	High definition TV	[Auto], [1080p], [1080i], [720p]	 MOVIE  PHOTO  MOVIE/ PHOTO	High definition image quality (HD)
XAVC S HD AVCHD	4K TV or High definition TV	[Auto], [2160p/1080p], [1080p], [1080i], [720p]	 MOVIE  MOVIE/ PHOTO	High definition image quality (HD)
			 PHOTO	4K image quality (when connected to a 4K TV)*

\* The resolution will be the HDMI Resolution set on your camcorder.

- Images will be played when [HDMI Resolution] is set to [Auto] (default setting).
- If images are not played properly with [Auto], change the [HDMI Resolution] setting. Select **[MENU]** → [Setup] → [  Connection ] → [HDMI Resolution] → desired setting.
- If your TV does not have an HDMI jack, connect the Multi/Micro USB Terminal of the camcorder to the video/audio input jacks of the TV using an AV cable (sold separately).



## I Connecting the camcorder to a network-compatible TV

Connect the camcorder to an access point with a security setting (page 33). Press  (View Images) on the camcorder, and then select **MENU** → [Wireless] → [ Function] → [View on TV] → image type to be played back.

- You can view AVCHD movies, MP4 movies, and photos only.

## Playing back trimmed movies (Trimming Playback) recorded in XAVC S 4K format

You can play back the movies recorded in XAVC S 4K file format while magnifying and trimming the part you want to watch, and also while zooming the scene up to the full high definition image quality.

### 1 Change the HDMI output setting to output 4K movies.

Select **MENU** → [Setup] → [ Connection] → [HDMI Resolution] → desired setting.

### 2 Connect the HDMI OUT jack of the camcorder to the HDMI IN jack of a TV using the HDMI cable supplied.

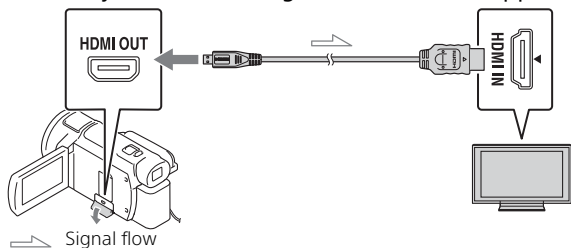

TV	[HDMI Resolution]
4K TV	[Auto]*, [2160p/1080p]*, [1080p], [1080i], [720p]
High definition TV	[Auto], [1080p], [1080i], [720p]

\* The screen turns blank for a few seconds when you turn on or off the trimmed movie playback function.

### 3 Touch (trimming on) on the LCD monitor during playback, and then select the part to be trimmed by touching there.

- The playback image is trimmed in high definition image quality (HD).

#### Notes

- Playback of trimmed movies is not available on the LCD monitor of the camcorder.

# Importing images to your computer

## What you can do with PlayMemories Home

PlayMemories Home allows you to import movies and photos to your computer to use them in a variety of ways.

- Update PlayMemories Home to the latest version before using.



Import images from the camcorder.

For Windows, the following functions are also available.



Viewing images on Calendar



Creating movie discs



Uploading images to network services

Playing back imported images



Sharing images on PlayMemories Online™



## How to download PlayMemories Home

PlayMemories Home can be downloaded from the following URL.  
<http://www.sony.net/pm/>

## How to check the computer system

You can check the computer requirements for the software at the following URL.  
<http://www.sony.net/pcenv/>



# Saving images on an external media device

How to store movies and photos to an external media device is explained here. Also refer to the instruction manual supplied with the external media device.

Store movies to a computer using PlayMemories Home software (page 27).

## How to store movies

Device	Cable	Image quality/ Recording format	Media
Recorder without a USB jack	AV cable (sold separately)	Standard definition image quality	DVD
External media device	VMC-UAM2 USB Adaptor Cable (sold separately)	4K/High definition image quality (HD) <ul style="list-style-type: none"><li>• XAVC S</li><li>• AVCHD</li></ul>	External media
Computer	Micro USB cable	4K/High definition image quality (HD) <ul style="list-style-type: none"><li>• XAVC S</li><li>• AVCHD</li></ul>	Computer and connected external media

- See the following website for the latest storage environment.  
<http://www.sony.net/>
- You can store images by connecting to a recorder with an analog AV cable (sold separately). Movies are copied with standard definition image quality (page 29).
- You can directly copy images to an external media device with the VMC-UAM2 USB Adaptor Cable (sold separately).

## How to connect a device

### | Recorder without a USB jack

Connect a recorder to the Multi/Micro USB Terminal of your camcorder using an AV cable (sold separately).

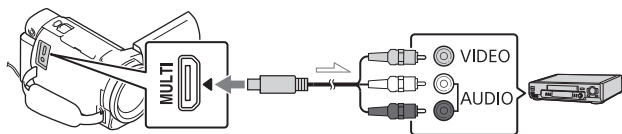

➤ Signal flow

- For how to save images, also refer to the instruction manual of your recording device.
- Movies are copied with standard definition image quality.

### | USB external hard disk

Connect an external media device to the Multi/Micro USB Terminal of your camcorder using VMC-UAM2 USB Adaptor Cable (sold separately).

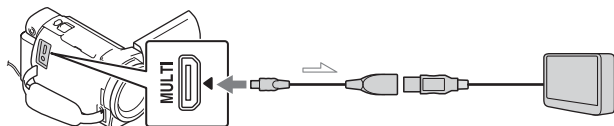

➤ Signal flow

- Movies are copied with 4K/high definition image quality (HD).

# Using the Wi-Fi function

## Installing Imaging Edge Mobile™ on your smartphone

For the latest information and more detailed information on the functions of Imaging Edge Mobile, visit the following URL.



<https://www.sony.net/iem/>

### | Android OS

Install Imaging Edge Mobile from Google Play.



### | iOS

Install Imaging Edge Mobile from App Store.



## Notes

- You may not be able to download Imaging Edge Mobile from Google Play or App Store depending on the country or the region. In that case, search for "Imaging Edge Mobile".
- If Imaging Edge Mobile is already installed in your smartphone, update the software to the latest version.
- The Wi-Fi function described here is not guaranteed to work on all smartphones and tablets.
- The Wi-Fi function of the camcorder cannot be used connected to a public wireless LAN.
- To use the One-touch functions (NFC) of the camcorder, a smartphone or tablet supporting the NFC function is required.
- The operation methods and display screens for the application are subject to change without notice by future upgrades.

## Transferring MP4 movies and photos to your smartphone

### One-touch connection with a smartphone supporting NFC

- 1 Activate the NFC function of the smartphone.
  - On an iPhone/iPad, launch Imaging Edge Mobile, and then select [Scan NFC/QR Code of the Camera] → [Scan NFC of the Camera] to activate the NFC function.
- 2 On the camcorder, play back an image to be sent to the smartphone.
  - You can transfer MP4 movies and photos only.
  - To select MP4 movies when you play back movies, see "Switching to MP4" (page 21).
- 3 Touch the camcorder to the smartphone.

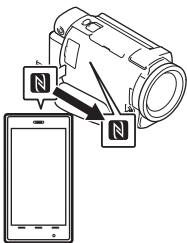

### Notes

- Cancel the sleep mode or unlock the screen on the smartphone beforehand.
- Make sure that **N** is displayed on the LCD monitor of the camcorder and the smartphone.
- Continue touching the camcorder to the smartphone without moving until Imaging Edge Mobile starts (1 to 2 seconds).
- If the camcorder cannot be connected with the smartphone by NFC, see "Connecting to a Wi-Fi network using the QR Code" (page 31).

### Connecting to a Wi-Fi network using the QR Code

- 1 Press the **▶** (View Images) button, then select **[MENU]** → [Wireless] → [Function] → [Send to Smartphone] → [Select on This Device] → image type.
- 2 Select the image you want to transfer, and add **✓**, and then select **[OK]** → **[OK]**.
  - The QR Code, SSID, and password are displayed.



- 3 Start up Imaging Edge Mobile.
- 4 Select [Scan QR Code of the Camera] from the screen of Imaging Edge Mobile.
- 5 Select [OK]. (If a message appears, select [OK] again.)
- 6 With your smartphone, read the QR Code displayed on the LCD monitor of the camcorder.

- Once the QR Code has read and the connection has been successfully established, the SSID (DIRECT-xxxx) and the password of the camcorder will be registered onto your smartphone. The subsequent Wi-Fi connection between the camcorder and your smartphone will only require selecting the SSID of the camcorder registered on your smartphone.
- If the camcorder cannot be connected with the smartphone by NFC and by reading the QR code, connect by using the SSID and the password.  
For more details, refer to "Help Guide".

## Using your smartphone as a wireless remote commander

You can record with the camcorder using your smartphone as a wireless remote commander.

- 1 On your camcorder, select **MENU** → [Wireless] → [Wi-Fi Function] → [Ctrl with Smartphone].
- 2 On your smartphone, perform in the same way as in step 6 in "Connecting to a Wi-Fi network using the QR Code" (page 31).  
When you use NFC, display the recording screen on your camcorder, and touch **N** on the camcorder to **N** on the smartphone.
- 3 Operate the camcorder on your smartphone.

### Notes

- Depending on local electrical interference or the smartphone's capabilities, the live view images may not be displayed smoothly.



## Saving movies and photos to your computer via Wi-Fi

Connect your computer to a wireless access point or wireless broadband router in advance.

### 1 Install the dedicated software in your computer (first time only).

PlayMemories Home

<http://www.sony.net/pm/>

- If the software is already installed in your computer, update the software to the latest version.

### 2 Connect your camcorder to an access point as follows (first time only).

If you cannot register, refer to the instruction of the access point, or contact the person who set up the access point.

#### If the wireless access point has a WPS button

- ① On your camcorder, select **[MENU]** → **[Wireless]** → **[Setting]** → **[WPS Push]**.
- ② Press the WPS button on the access point you want to register.

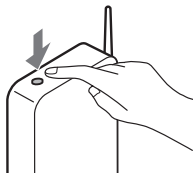

#### If you know the SSID and the password of your wireless access point

- ① On your camcorder, select **[MENU]** → **[Wireless]** → **[Setting]** → **[Access point settings]**.
- ② Select the access point you want to register, enter the password, then select **[Next]**.

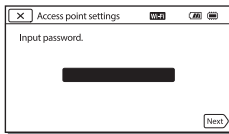

### 3 If your computer is not started, turn on the computer.

### 4 Start sending images from the camcorder to the computer.

- ① Press the **[View Images]** button on your camcorder.
- ② Select **[MENU]** → **[Wireless]** → **[Function]** → **[Send to Computer]**.
  - Images are automatically transferred to and saved on the computer.
  - Only newly recorded images are transferred. Importing movies and multiple photos may take time.

# Using the menus

## 1 Select **MENU**.



## 2 Select a category.

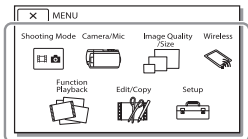

## 3 Select a desired menu item.

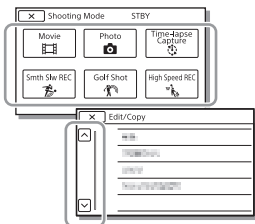

Scroll the menu items up or down.

- Select **X** to finish setting the menu or to return to the previous menu screen.

## Menu lists

### Shooting Mode

Movie

Photo

Time-lapse Capture

Smth Slw REC<sup>\*1</sup>

Golf Shot<sup>\*1</sup>

High Speed REC<sup>\*2</sup>

### Camera/Mic

#### Manual Settings

White Balance

Spot Meter/Fcs

Spot Meter

Spot Focus

Exposure

Focus

IRIS

Shutter Speed

AGC Limit

AE Shift

White Balance Shift

Low Lux

#### Camera Settings

Scene Selection

Picture Effect

Cinematone

Fader

Self-Timer

SteadyShot

SteadyShot

Digital Zoom

Filter/Protector

Auto Back Light

Manual Ring Setting<sup>\*3</sup>

NIGHTSHOT Light<sup>\*3</sup>

 Face

Face Detection

Smile Shutter

Smile Sensitivity

 Flash<sup>\*4</sup>

Flash

Flash Level

Red Eye Reduction

 Microphone

My Voice Canceling

Blt-in Zoom Mic

Auto Wind NR

Audio Mode

Audio Rec Level

 Shooting Assist

My Button

Focus Magnifier<sup>\*3</sup>

Grid Line

Display Setting

Zebra

Peaking

Audio Level Display

 Image Quality/Size

 REC Mode

 Frame Rate

Dual Video REC

 File Format

 Image Size

 Wireless

 Function

Ctrl with Smartphone

Multi Camera Control

Send to Smartphone

Send to Computer

View on TV

 Setting

Airplane Mode

Multi Camera Ctrl Set

WPS Push

Access point settings

Edit Device Name

Disp MAC Address

SSID/PW Reset

Network Info Reset

 Playback Function

Event View

 Edit/Copy

Delete

Protect

 Highlight

Copy

Direct Copy<sup>\*5</sup>

 Setup

 Media Settings

Media Select<sup>\*6</sup>

Media Info

Format

Repair Img. DB F.

File Number

 Playback Settings

Data Code

Volume

Motion Interval ADJ

Download Music<sup>\*7</sup>

Empty Music<sup>\*7</sup>

**00:00** TC/UB

TC/UB Disp

TC Preset

UB Preset

TC Format

TC Run

TC Make

UB Time Rec

 Connection

TV Type

HDMI Resolution

CTRL FOR HDMI

USB Connect

USB Connect Setting

USB LUN Setting

 General Settings

Beep

Monitor Brightness

REC Lamp

Remote Ctrl

Power ON w/monitor<sup>\*8</sup>

Language Setting

24p Mode<sup>\*9</sup>Cancel 24p Mode<sup>\*9</sup>

Battery Info

Power Save

Initialize

Demo Mode

Version

 Clock Settings

Date &amp; Time Setting

Area Setting

<sup>\*2</sup> When image size is set to [XAVC S HD]

<sup>\*3</sup> FDR-AX60

<sup>\*4</sup> You can set this item when you use a flash (sold separately).

<sup>\*5</sup> You can set this item when you use an external media device (sold separately).

<sup>\*6</sup> FDR-AX45/AX60

<sup>\*7</sup> The feature may not be available depending on the countries/regions.

<sup>\*8</sup> FDR-AX43/AX45

<sup>\*9</sup> 1080 50i-compatible models

<sup>\*1</sup> When image size is set to [AVCHD]

# Precautions

## AC Adaptor

Do not short-circuit the battery terminal with any metallic objects. This may cause a malfunction.

## Playing back images with other devices

You may not be able to play back images that were recorded on your camcorder with other devices normally. Also, you may not be able to play back images recorded on other devices with your camcorder.

## Recording and playback

- Avoid rough handling, disassembling, modifying, physical shock, or impact such as hammering, dropping or stepping on the product. Be particularly careful with the lens.
- To ensure stable operation of the memory card, it is recommended to format the memory card with your camcorder before the first use. Formatting the memory card will erase all the data stored on it and the data will be irrecoverable. Save your important data on your PC, etc.
- Confirm the direction of the memory card. If you forcibly insert the memory card in the wrong direction, the memory card, memory card slot, or image data may be damaged.
- Before starting to record, test the recording function to make sure the image and sound are recorded without any problems.

- Television programs, films, video tapes, and other materials may be copyrighted. Unauthorized recording of such materials may be a violation of the copyright laws.
- Compensation for the content of recordings cannot be provided, even if recording or playback is not possible due to a malfunction of the camcorder, recording media, etc.
- The camcorder is not dustproofed, dripproofed or waterproofed.
- Do not let your camcorder get wet, for example, from rain or sea water. If your camcorder gets wet, it may malfunction. Sometimes this malfunction cannot be repaired.
- Do not leave the lens or the viewfinder exposed to a strong light source such as sunlight. Because of the lens's condensing function, doing so may cause smoke, fire, or a malfunction inside the camcorder body or the lens.
- When you shoot with backlighting, keep the sun sufficiently far away from the angle of view. Otherwise, the sunlight may enter the focus inside the camcorder and cause smoke or fire. Even if the sun is slightly away from the angle of view, it may still cause smoke or fire.
- Do not directly expose the lens to beams such as laser beams. That may damage the image sensor and cause the camcorder to malfunction.

- Do not use the camcorder near strong radio waves or radiation. The camcorder may not be able to record or play back images properly.
- Do not use the camcorder on a sandy beach or anywhere dusty. Doing so may cause your camcorder to malfunction.
- If moisture condensation occurs, stop using the camcorder until moisture evaporates.
- Do not subject the camcorder to mechanical shock or vibration. If you do so, the camcorder may operate incorrectly or may not record images. In addition, the recording medium or recorded data may be damaged.

### LCD monitor

The LCD monitor is manufactured using extremely high-precision technology, so over 99.99% of the pixels are operational for effective use. However, there may be some tiny black points and/or bright points (white, red, blue, or green in color) that appear constantly on the LCD monitor. These points are normal results of the manufacturing process and do not affect the recording in any way.

### Camcorder temperature

The camcorder and battery pack become warm during operation. This is normal.

### Overheat protection

Depending on the camcorder and battery temperature, you may be unable to record movies or the power may turn off automatically to protect the camcorder. A message will be displayed on the

LCD monitor before the power turns off or you can no longer record movies. In this case, leave the power off and wait until the camcorder and battery temperature goes down. If you turn on the power without letting the camcorder and battery cool enough, the power may turn off again or you may be unable to record movies.

### Deactivating wireless LAN (Wi-Fi, NFC, etc.) temporarily

When you board an airplane, you can deactivate the Wi-Fi function temporarily. Select **[MENU]** → [Wireless] → [Wi-Fi Setting] → [Airplane Mode] → [On].

### Wireless LAN

We assume no responsibility whatsoever for any damage caused by unauthorized access to, or unauthorized use of, destinations loaded on the camcorder, resulting from loss or theft.

### About the security on using Wireless LAN products

- Please ensure that you always use a secured wireless network with your devices to avoid hacking, unapproved third party access and other vulnerabilities.
- It is important to set security when using the wireless network function.
- Sony makes no guarantees and is not responsible for any damage resulting from having inadequate security or using the wireless network function.

## Sony accessories

Using this unit with products from other manufacturers may affect its performance, leading to accidents or malfunction.

## Troubleshooting

If you run into any problems using your camcorder:

- Check your camcorder referring to Help Guide (page 3).
- Disconnect the power source, attach the power source again after about 1 minute, and turn the camcorder on.
- Initialize your camcorder (page 36).  
All settings, including the clock setting, are reset.
- Contact your Sony dealer or local authorized Sony service facility.

## For Customers in the U.S.A.

For question regarding your product or for the Sony Service Center nearest you, call 1-800-222-SONY (7669) .

## Regulatory Information

### Supplier's Declaration of Conformity

Trade Name: SONY

Model.: FDR-AX43

Responsible Party: Sony  
Electronics Inc.

Address: 16535 Via Esprillo,  
San Diego, CA 92127  
U.S.A.

Telephone Number: 858-942-2230

This device complies with Part 15 of the FCC Rules. Operation is subject to the following two conditions: (1) This device may not cause harmful interference, and (2) this device must accept any interference received, including interference that may cause undesired operation.

# Specifications

---

## System

Signal format:

- UHDTV
- HDTV
- NTSC color, EIA standards (1080 60i-compatible models)
- PAL color, CCIR standards (1080 50i-compatible models)

Movie recording format:

- XAVC S (XAVC S format)
- Video: MPEG-4 AVC/H.264
- Audio: LPCM 2ch (48 kHz/16 bit)
- AVCHD (AVCHD format Ver.2.0 compatible)
- Video: MPEG-4 AVC/H.264
- Audio: Dolby Digital 2ch/5.1ch
- Dolby Digital 5.1 Creator<sup>\*1</sup>
- MP4
- Video: MPEG-4 AVC/H.264
- Audio: MPEG-4 AAC-LC 2ch
- <sup>\*1</sup> Manufactured under license from Dolby Laboratories.

Photo file format:

- DCF Ver.2.0 Compatible
- Exif Ver.2.3 Compatible
- MPF Baseline Compatible

Viewfinder (FDR-AX60):

- 0.6 cm (0.24 type) Color
- 1 555 200 dots equivalent

Recording media (Movie/Photo):

- Internal memory: 64 GB<sup>\*2</sup>(FDR-AX45/AX60)
- XAVC S 4K (100Mbps), XAVC S HD High Speed REC (100Mbps)
- Movie:
  - SDHC memory card (UHS speed class 3 or faster)<sup>\*3</sup>
  - SDXC memory card (UHS speed class 3 or faster)<sup>\*3</sup>
  - microSDHC memory card (UHS speed class 3 or faster)<sup>\*3</sup>

microSDXC memory card (UHS speed class 3 or faster)<sup>\*3</sup>

XAVC S HD, XAVC S 4K (60Mbps), Movie:

- SDHC memory card (Class 10, or UHS speed class 1 or faster)<sup>\*3</sup>
- SDXC memory card (Class 10, or UHS speed class 1 or faster)<sup>\*3</sup>
- microSDHC memory card (Class 10, or UHS speed class 1 or faster)<sup>\*3</sup>
- microSDXC memory card (Class 10, or UHS speed class 1 or faster)<sup>\*3</sup>
- AVCHD, Photo:
  - Memory Stick Micro (Mark2)
  - Memory Stick PRO-HD Duo
  - SD card (Class 4 or faster, or UHS speed class 1 or faster)
  - microSD memory card (Class 4 or faster, or UHS speed class 1 or faster)

<sup>\*2</sup> The capacity that a user can use (Approx.): 62.4 GB

1 GB equals 1 billion bytes, a portion of which is used for system management and/or application files. Only pre-installed demonstration movie may be deleted.

<sup>\*3</sup> Capacity of 4 GB or more is required.

Image device:

- 1/2.5-type (7.20 mm) back-illuminated Exmor R™ CMOS sensor
- Recording pixels (photo, 16:9):
  - Max. 16.6 mega pixels (5 440 × 3 056)<sup>\*4</sup>
  - Gross: Approx. 8.57 mega pixels
  - Effective (movie, 16:9)<sup>\*5</sup>: Approx. 8.29 mega pixels
  - Effective (photo, 16:9):



Approx. 8.29 mega pixels  
Effective (photo, 4:3):  
Approx. 6.22 mega pixels

#### Lens:

ZEISS Vario-Sonnar T\* Lens  
20× (Optical)<sup>\*5</sup>, 4K: 30× (Clear  
Image Zoom, while recording  
movies)<sup>\*6</sup> HD: 40× (Clear Image  
Zoom, while recording  
movies)<sup>\*6</sup>, 250× (Digital)

Filter diameter:

55 mm (2 1/4 in.)

F2.0 - F3.8

Focal length:

f= 4.4 mm - 88 mm (3/16 in. -  
3 1/2 in.)

When converted to a 35 mm  
still camera

For movies<sup>\*5</sup>:

f=26.8 mm - 536 mm  
(1 1/16 in. - 21 1/8 in.) (16:9)

For photos:

f=26.8 mm - 536 mm  
(1 1/16 in. - 21 1/8 in.) (16:9)

Color temperature: [Auto], [One  
Push], [Indoor], [Outdoor]

Minimum illumination:

4K: 9 lx (lux), HD: 6 lx (lux) (in  
default setting, shutter speed  
1/60 second)

4K: 1.8 lx (lux), HD: 1.2 lx (lux)  
([Low Lux] is set to [On], shutter  
speed 1/30 second)

NightShot (FDR-AX60): 0 lx  
(lux) (shutter speed 1/60  
second)

<sup>\*4</sup> The unique image  
processing system of Sony's  
BIONZ-X allows still image  
resolution equivalent to the  
sizes described.

<sup>\*5</sup> [SteadyShot] is set to  
[Standard] or [Off].

<sup>\*6</sup> [SteadyShot] is set to  
[Active].

---

### Input/Output connectors

HDMI OUT jack: HDMI micro  
connector

MIC input jack: Stereo minijack  
( $\phi$ 3.5 mm)

Headphone jack: Stereo minijack  
( $\phi$ 3.5 mm)

USB jack: Multi/Micro USB  
Terminal\*

\* Supports Micro USB compatible  
devices.

USB connection is only for output  
(For customers in Europe).

---

### LCD monitor

Picture: 7.5 cm (3.0 type, aspect  
ratio 16:9)

Total number of pixels:

FDR-AX43/AX45:

460 800 (960 × 480)

FDR-AX60:

921 600 (1 440 × 640)

---

### Wireless LAN

Supported format:

IEEE 802.11 b/g/n

Frequency band: 2.4 GHz

Security: WEP/WPA-PSK/WPA2-  
PSK

Connection method: Wi-Fi  
Protected Setup™ (WPS)/  
Manual

Access method: Infrastructure  
mode

NFC: NFC Forum Type 3 Tag  
compliant

---

### General

Power requirements:

DC 7.4V (battery pack),

DC 8.4 V (AC Adaptor)

USB Charging: DC 5 V 1 500 mA

Average power consumption:

During camera recording using the viewfinder (FDR-AX60): 4K: 5.1 W, HD: 3.6 W\*

During camera recording using LCD monitor at normal brightness: 4K: 5.1 W, HD: 3.6 W\*

\* in AVCHD FH mode

Operating temperature: 0 °C to 40 °C (32 °F to 104 °F)

Storage temperature: -20 °C to +55 °C (-4 °F to +131 °F)

Dimensions (approx.):

FDR-AX43/AX45:  
73 mm × 80.5 mm × 142.5 mm  
(2 7/8 in. × 3 1/4 in. × 5 5/8 in.)  
(w/h/d) including the projecting parts

73 mm × 80.5 mm × 173 mm  
(2 7/8 in. × 3 1/4 in. × 6 7/8 in.)  
(w/h/d) including the projecting parts, and the supplied rechargeable battery pack

FDR-AX60:  
73 mm × 80.5 mm × 161.0 mm  
(2 7/8 in. × 3 1/4 in. × 6 3/8 in.)  
(w/h/d) including the projecting parts

73 mm × 80.5 mm × 173 mm  
(2 7/8 in. × 3 1/4 in. × 6 7/8 in.)  
(w/h/d) including the projecting parts, and the supplied rechargeable battery pack

Mass (approx.):

FDR-AX43/AX45:  
510 g (1 lb 2 oz) main unit only  
600 g (1 lb 5.2 oz) including the supplied rechargeable battery pack NP-FV70A

FDR-AX60:

535 g (1 lb 2.9 oz) main unit only

625 g (1 lb 6 oz) including the supplied rechargeable battery pack NP-FV70A

## | AC Adaptor AC-L200 D

Power requirements: AC 100 V - 240 V, 50 Hz/60 Hz

Power consumption: 18 W

Output voltage: DC 8.4 V\*

\* See the label on the AC Adaptor for other specifications.

## | Rechargeable battery pack NP-FV70A



Output voltage: DC 7.3 V

Maximum charge voltage: DC 8.4 V

Maximum charge current: 2.3 A

Design and specifications are subject to change without notice.

## | Trademarks

- AVCHD, AVCHD Progressive, AVCHD logotype and AVCHD Progressive logotype are trademarks of Panasonic Corporation and Sony Corporation.
- XAVC S and  are registered trademarks of Sony Corporation.
- Memory Stick and  are trademarks or registered trademarks of Sony Corporation.
- "InfoLITHIUM" is a trademark of Sony Corporation.
- BRAVIA is a trademark of Sony Corporation.

- Blu-ray Disc™ and Blu-ray™ are trademarks of the Blu-ray Disc Association.
- Dolby and the double-D symbol are trademarks of Dolby Laboratories.
- The terms HDMI and HDMI High-Definition Multimedia Interface, and the HDMI Logo are trademarks or registered trademarks of HDMI Licensing Administrator, Inc. in the United States and other countries.
- Windows is either registered trademark or trademark of Microsoft Corporation in the United States and/or other countries.
- Mac is a registered trademark of Apple Inc. in the United States and other countries.
- SDXC logo is a trademark of SD-3C, LLC.
- Android and Google Play are trademarks of Google Inc.
- Wi-Fi, the Wi-Fi logo, Wi-Fi PROTECTED SET-UP are registered trademarks of the Wi-Fi Alliance.
- The N Mark is a trademark or registered trademark of NFC Forum, Inc. in the United States and in other countries.
- YouTube and the YouTube logo are trademarks or registered trademarks of Google Inc.
- iPhone and iPad are trademarks of Apple Inc., registered in the U.S. and other countries.
- QR Code is registered trademark of DENSO WAVE INCORPORATED.

All other product names mentioned herein may be the trademarks or registered trademarks of their respective companies. Furthermore, ™ and ® are not mentioned in each case in this manual.

## On GNU GPL/LGPL applied software

The software that is eligible for the following GNU General Public License (hereinafter referred to as "GPL") or GNU Lesser General Public License (hereinafter referred to as "LGPL") are included in this product.

This informs you that you have a right to have access to, modify, and redistribute source code for these software programs under the conditions of the supplied GPL/LGPL.

Source code is provided on the web.

Use the following URL to download it.

<http://oss.sony.net/Products/Linux>

We would prefer you do not contact us about the contents of source code.



### About copies of the licenses (in English).

Establish a Mass Storage connection between this product and a computer, and read the files in the "LICENSE" folder in "PMHOME."

# Parts and controls

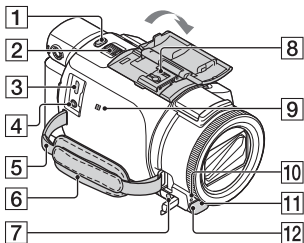
Figures in ( ) are reference pages.



- 1** PHOTO button (15, 17)
- 2** Power zoom lever (17)
- 3** Multi/Micro USB Terminal  
Supports Micro USB compatible devices. This terminal does not support VMC-AVM1 Adaptor Cable (sold separately). You cannot use accessories via an A/V remote connector.
- 4**  (microphone) jack (PLUG IN POWER)
- 5** Loop for a shoulder belt
- 6** Grip belt
- 7**  (headphones) jack
- 8** Multi interface shoe



For details on compatible accessories of the Multi interface shoe, visit the Sony web site in your area, or consult your Sony dealer or local authorized Sony service facility.

Operations with other manufacture's accessories are not guaranteed.

If you use a shoe adaptor (sold separately), you can also use

accessories compatible with an Active Interface Shoe.

To prevent failure, do not use a commercially available flash with high-voltage synchro terminals or with reverse polarity.

- 9** N mark (31)  
NFC: Near Field Communication
- 10** Camera recording lamp
- 11** Remote sensor
- 12** NIGHTSHOT light (FDR-AX60)

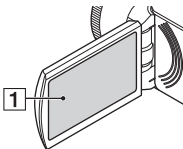

- 1** LCD monitor/Touch panel

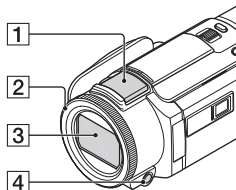



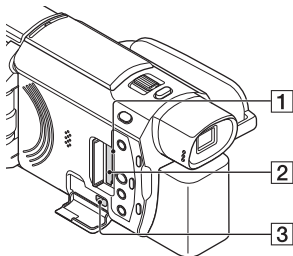

- 1** Built-in microphone
- 2** MANUAL ring (FDR-AX60) (18)  
Manual functions can be assigned to the button and the dial.
- 3** Lens (ZEISS lens)
- 4** MANUAL button (FDR-AX60)

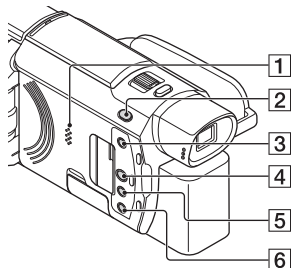

- 1** Memory card access lamp (12)
- 2** Memory card slot (12)
- 3** HDMI OUT jack



- 1** Speaker
- 2**  (Shooting Mode) button (17) (FDR-AX60)
- 3**  (Create highlight movies) button  
Creates highlight movies (MP4 movies) from movies you have recorded.
- 4**  (View Images) button (19)
- 5** NIGHTSHOT button (FDR-AX60)
- 6**  (ON/STANDBY) button

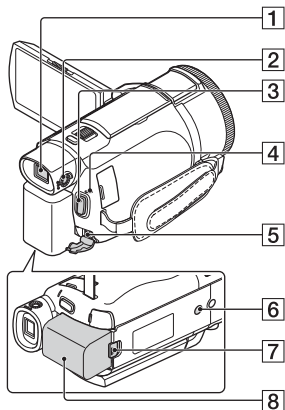

## | To fasten the grip belt

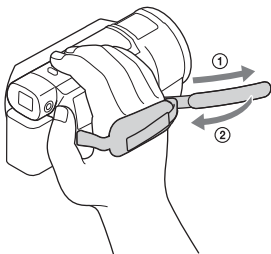

- 1** Viewfinder (FDR-AX60)  
The camcorder is turned on when the viewfinder is pulled out.
- 2** Viewfinder lens adjustment dial (FDR-AX60)  
If the indications in the viewfinder appear blurred, turn the viewfinder lens adjustment dial.
- 3** START/STOP button (15)
- 4** POWER/CHG (charge) lamp (8)
- 5** DC IN jack
- 6** Tripod receptacle  
Attach a tripod (sold separately: the length of the screw must be less than 5.5 mm (7/32 in.)). Depending on the specifications of the tripod, this product may not attach in the proper direction.
- 7** BATT (battery) release lever (10)
- 8** Battery pack (8)

# Index

## A

- AC Adaptor 8
- Android 30
- App Store 30
- Assigning a menu item 18
- AVCHD 4, 6

## B

- Battery pack 8
- Beep 11

## C

- Charging the battery pack 8
- Charging the battery using your computer 9
- Charging time 9
- Computer 27
- Computer system 27

## D

- Date and time 11
- Delete 21
- Dual Video REC 15

## E

- Edit 19

## F

- Format 14
- Full charge 9

## G

- Google Play 30
- Grip belt 46

## H

- HDMI cable 23
- Help Guide 3
- Highlight Movie Maker 22

## I

- Importing images to your computer 27

Install 30

iOS 30

## L

LCD monitor 44

## M

- Manual recording 18
- Memory card 12
- Memory Stick Micro (M2) 13
- Memory Stick PRO Duo 13
- Menu lists 34
- Menus 34
- Micro USB cable 9
- microSD memory card 12
- Movies 15
- MP4 31
- My Voice Canceling 16

## N

- Network 25
- NFC 31

## P

- Photos 17
- Playback 19
- PlayMemories Home 27
- PlayMemories Online 27
- Power on 11
- Precautions 37

## R

- Recording 15
- Recording media 14
- Recording time 16
- Recording/playback time 9

## S

- Smartphone 30
- Software 27
- Specifications 40
- Supplied items 7

## **T**

- Touch panel 44
- Trimming Playback 25
- Tripod 46
- Troubleshooting 39
- TV 23

## **W**

- Wall outlet (wall socket) 9
- Wi-Fi 30
- Windows 27
- Wireless access point 33

## **X**

- XAVC S 4K 4, 5
- XAVC S HD 4, 5

## **Z**

- Zoom 15

Additional information on this product and answers to frequently asked questions can be found at our Customer Support Website.

**<http://www.sony.net/>**

