



Questo manuale d'istruzione è fornito da trovaprezzi.it. Scopri tutte le offerte per [Sony PlayStation VR2 Visore](#) o cerca il tuo prodotto tra le [migliori offerte di Visori Realtà Virtuale](#)

SONY[®]



PlayStation[®] VR2

Instruction Manual

Before using the product, you must first carefully read the Health and Safety information, Precautions, and any manuals for compatible hardware.
Retain instructions for future reference. Parents or guardians of children should read this manual for safe use.

Contents

Health and Safety 4

Let's get started 8

Use the PS VR2 Sense controller10

Remove your VR headset11

Turn off your VR headset12

About PS VR212

Part names14

Use and handling17

Care and cleaning18

Specifications19

End of life product recycling20

Compliance information21

Copyright and trademarks21

Further information 22

For help with setup and tips on usage, you can check out the video here:



playstation.com/psvr2-help/

Health and Safety

This product has been designed with the highest concern for safety. However, any electrical device, if used improperly, has the potential for causing fire, electrical shock or personal injury. Observe all warnings, precautions, and instructions. Stop use and disconnect cables immediately if the product functions in an abnormal manner, produces unusual sounds or smells or becomes too hot to touch.



USE BY CHILDREN

PlayStation®VR2 is not for use by children under age 12.

SEIZURES INDUCED BY LIGHT STIMULATION (PHOTOSENSITIVE EPILEPSY)

If you have an epileptic condition or have had seizures, **consult your doctor prior to using this product.**

Some individuals are sensitive to flashing or flickering lights or geometric shapes and patterns, may have an undetected epileptic condition and may experience epileptic seizures when playing video games or watching video content.

DISCONTINUE USE IMMEDIATELY and consult your doctor if you experience any of the following health problems or symptoms when exposed to flashing or flickering lights or other light stimulation whilst playing video games or watching video content: eye soreness, altered vision, migraine, muscle twitching, convulsion or other involuntary movements, blackout, loss of awareness, confusion, or disorientation.

In addition to the above, DISCONTINUE USE IMMEDIATELY if you experience any of the following symptoms: headache, dizziness, nausea, fatigue, similar symptoms to motion sickness, or discomfort or pain in any body part such as eyes, ears, hands, arms, or feet whilst playing. If the condition persists, **seek medical attention.**

- Do not use PS VR2 if you are tired or need sleep, are dizzy, light-headed, nauseated, sick, under the influence of alcohol or drugs, or have an impaired sense of motion or balance. Consult a doctor before using PS VR2 if you suffer from a serious medical condition.
- Some people may experience motion sickness, nausea, disorientation, blurred vision, or other discomfort. If experienced, stop using immediately and remove the VR headset. If you experience any discomfort after use, rest and do not engage in any activities that require unimpaired vision, balance, or coordination until after symptoms have completely disappeared.
- **IMMEDIATELY DISCONTINUE USE** and consult your doctor before resuming gameplay if you or your child experience any of the following health problems or symptoms: dizziness, altered vision, eye or muscle twitches, loss of awareness, disorientation, seizures, or any involuntary movement or convulsion. **RESUME GAMEPLAY ONLY ON APPROVAL OF YOUR DOCTOR.**
- It may take some time to become accustomed to images from PS VR2. During initial use, it is recommended that you use the product for short periods of time.

BREAKS

Avoid prolonged continuous use of PS VR2.

Generally we recommend that you take 15 minute breaks for every hour of play. However, when viewing virtual reality content, the length and frequency of necessary breaks may vary from person to person—please take breaks that are long enough to allow any feelings of discomfort to subside.

RADIO WAVES

Radio waves may affect electronic equipment or medical devices (for example, pacemakers), which may cause malfunctions and possible injuries.

- If you use a pacemaker or other medical device, consult your doctor or the manufacturer of your medical device before using the wireless networking feature (Bluetooth®).
- Do not use the wireless networking feature in the following locations:
 - Areas where wireless network use is prohibited, such as in hospitals. Abide by medical institution regulations when using the product on their premises.

- Areas near fire alarms, automatic doors and other types of automated equipment.

MAGNETS AND MEDICAL DEVICES

These products have magnets which may interfere with pacemakers, defibrillators and programmable shunt valves or other medical devices. Do not place these products close to such medical devices or persons who use such medical devices. Consult your doctor before using these products if you use such medical devices.

VIBRATION FUNCTION

- Do not use the vibration function of the VR headset if you use pacemakers, defibrillators, programmable shunt valves, or other medical devices.
- Do not use the vibration function of the VR headset or the vibration function and the trigger effect function on PlayStation VR2 Sense™ controller if you have any ailment or injury that may be affected by this vibration function or any ailments or injury to body parts such as the head, bones, joints, or muscles of your hand or arm.

To turn these functions on or off for the VR headset or controller, go to your PS5 console's home screen, and then select **Settings**  **> Accessories**.

VOLUME LEVEL

Permanent hearing loss may occur if the headset or headphones are used at high volume. Set the volume to a safe level. Over time, increasingly loud audio may start to sound normal but can actually be damaging your hearing. If you experience ringing, discomfort in your ears or muffled speech, stop listening and have your hearing checked. The louder the volume, the sooner your hearing could be affected.

To protect your hearing:

- Limit the amount of time you use the headset or headphones at high volume.
- Avoid raising the volume to block out noisy surroundings.
- Lower the volume if you can't hear people speaking near you.

LITHIUM-ION BATTERY

The controller contains a lithium-ion rechargeable battery. Do not handle damaged or leaking lithium-ion batteries. If the built-in battery fluid leaks, stop using the product immediately and contact the appropriate PlayStation customer service helpline which can be found within the accompanying documentation. If the material gets into the eyes, do not rub. Immediately flush the eyes with clean water and seek medical attention. If the material comes into contact with the skin or clothes, immediately rinse the affected area with clean water and consult your doctor. Do not allow the battery to come into contact with fire or subject it to extreme temperatures such as in direct sunlight, in a vehicle exposed to the sun or near a heat source. Never attempt to open, crush, heat, or set fire to the controller or the battery. Do not leave the battery charging for a prolonged period of time when the controller is not in use.

SURROUNDINGS AND PLAY AREA

- Wearing the VR headset completely blocks your ability to see your surroundings. To avoid causing an accident or injury, such as hitting or stepping on people, walls, furniture, or objects, or losing balance and falling, be aware of the following:
 - Before wearing the VR headset, make sure there is sufficient clear space around you. Check that there are no people, pets, objects, furniture, or stairs around you or in the Play Area. Check that the floor is stable and an even surface.
 - The Play Area function requires clear space in order to define a sufficient area. It may not detect space completely accurately so make sure to leave a buffer space between walls, furniture, or anything else that you may trip over or collide with when setting up the Play Area.
 - While you are playing, make sure to keep young children and pets away from the Play Area.
 - Do not move around when using content that does not support Roomscale (▶▶ page 13).
 - Before beginning play, check that the VR headset cable is not wrapped around your body or limbs, and check frequently during play.
 - While wearing the VR headset, use caution when moving around. Avoid extreme or excessively fast movements of the head, limbs, or body.

Health and Safety

- In see-through view, your field of view is narrow and your sense of depth is different from normal conditions. Failure to follow these precautions may cause an accident or injury, such as hitting people, walls, furniture, or objects, or losing balance and falling. Check your surroundings and move slowly and carefully.

SURROUNDINGS AND USE OF THE CONTROLLER

Be careful that you do not hit a person or object when you use the controller. If either of the controllers hits a person or object, it may cause an accident, injury, or malfunction. Observe the following when you use the controller.

- Check that there is enough space around you before using the controller.
- Do not use either of the controllers while the USB cable is connected.
- Pass your hands through the straps attached to each controller and secure them to your wrists before use.
- Hold each of the controllers firmly to prevent them from being thrown out of your hands. Do not shake either of the controllers with excessive force.

YOUNG CHILDREN INJURIES

Keep the product out of the reach of young children. Young children may swallow small parts, pull on cables and cause the VR headset or the controller to fall, or wrap the cables around themselves, which may inflict injury or cause an accident or a malfunction.

NEVER DISASSEMBLE OR MODIFY THE PRODUCT OR ACCESSORIES

There is a risk of fire, electric shock, or injury.

Precautions

Discomfort to your skin

Do not use the VR headset, headphones, or headset if they cause discomfort to your skin. If symptoms do not subside even after discontinuing use, seek medical attention.

Static shock

When using the headset or headphones in particularly dry air conditions, you may sometimes experience a small and quick (static) shock on your ears. This is a result of static electricity accumulated in the body, and is not a malfunction of your headset or headphones. This effect could be reduced by wearing clothes made from materials that do not easily generate static shock.

Wearing the VR headset

- It is important that you properly wear the VR headset during use.
 - You can check how to wear the VR headset properly from your PS5 console's home screen by selecting **Settings**  **> Accessories > PlayStation VR2**.
 - Do not overtighten the headband adjustment dial.
 - You can use the VR headset while wearing glasses. When you adjust the position of the scope, be careful not to hit the lenses with your glasses.
- Regularly check the VR headset's fit to ensure it is being worn properly.

Moisture condensation

If PS VR2 is moved directly from a cold location to a warm location, moisture may condense inside the VR headset or controller. If this occurs, the product may not operate properly. In this case, disconnect the VR headset cable from your PS5 console, turn off the controller, and leave them for several hours. If the product still does not operate properly, please contact customer support (▶▶ page 22).

Unusual or unresponsive behaviour

Press the  (power) button on the VR headset for at least seven seconds to force a shutdown, and then turn on the headset again. If the problem persists, restart the PS5 console.

High temperature message

If the VR system's internal temperature becomes elevated, a message will be displayed. In this case, turn off the VR headset and leave it unused for a while. Make sure that you are not using it in a hot area or with the vents blocked. If you continue using it in these conditions, the VR headset will not function properly. After the VR headset cools down, move it to a location with good ventilation, and then resume use.

VR headset screen

- Keep the VR headset's attachment sensor free from any obstacles. If the attachment sensor is blocked, the screen will not turn off automatically even if you remove the VR headset. If an image appears on the screen for an extended period of time, it might cause a screen burn and a faint image might remain permanently on the screen.
- Black (dark) pixels and continuously lit pixels may appear in certain locations on the screen. The appearance of such spots is a normal occurrence associated with screens and is not a sign of a system malfunction. Screens are made using highly precise technology. However, a very small number of dark pixels or continuously lit pixels may exist and colour irregularities or brightness irregularities may be visible on each screen.

Liquid, dust, smoke, steam, and heat

- Always ensure the product and its connectors are free of liquid, excess dust and small particles.
- Do not leave the product in the following areas during use, storage, or transportation.
 - Areas exposed to smoke or steam
 - Areas with high humidity, dust, or cigarette smoke
 - Areas near heating appliances, areas exposed to direct sunlight, or areas that retain heat

Set up and handling

- Do not use the cables if they are damaged or modified.
- Do not place heavy items on the product or cables, throw or drop the product, or otherwise expose it to strong physical impact.
- Do not place the product on surfaces that are unstable, tilted, or subject to vibration.
- Do not leave the product on the floor.
- Do not walk on the cables or pinch them, particularly near to the connectors.
- Do not pull or bend the cables with excessive force.
- Do not touch the connectors or insert any foreign objects into them or the product.
- Unplug the cables if you want to clean or move the product or do not intend to use it for an extended period of time.
- Do not swing the VR headset around by the cable.
- Do not unplug the VR headset cable until the power indicator is red or turned off. Unplugging the cable while the lights are white and the VR headset is turned on, may cause a malfunction.
- Do not expose the product, battery, or accessories to high temperatures, high humidity, or direct sunlight during operation, transportation, and storage.

Let's get started

1 Connect the VR headset to your PlayStation®5 console.

Connect the VR headset cable to the USB Type-C® port (SuperSpeed USB 10Gbps).

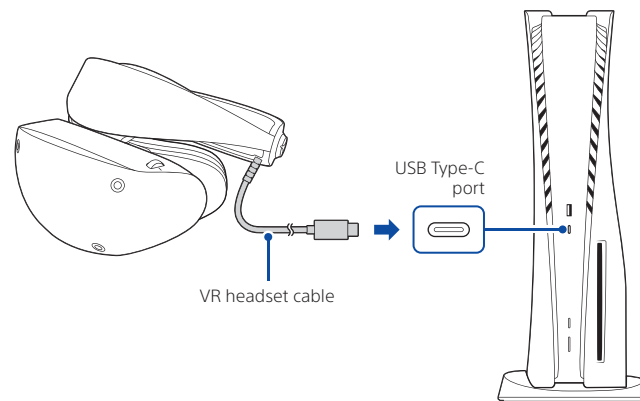

2 Turn on.

PS5® console

Press the  (power) button on your PS5 console.

VR headset

Press the  (power) button on your VR headset. The power indicator blinks white and then turns solid white.

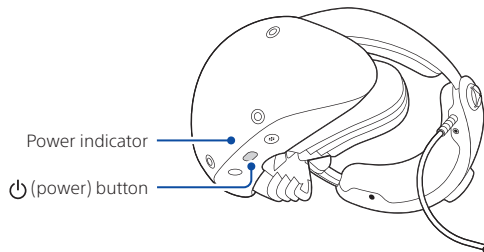

If your VR headset doesn't turn on, the cable might not be properly connected. While holding the scope adjustment button, slide out the scope and disconnect the cable. Then, reconnect the cable, making sure it's fully inserted.

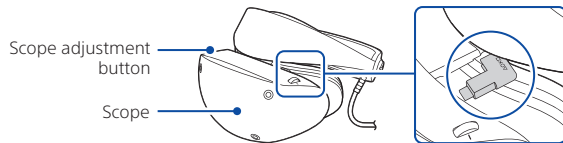

3 Set up PS VR2.

- ① Make sure you have the necessary accessories for setup.

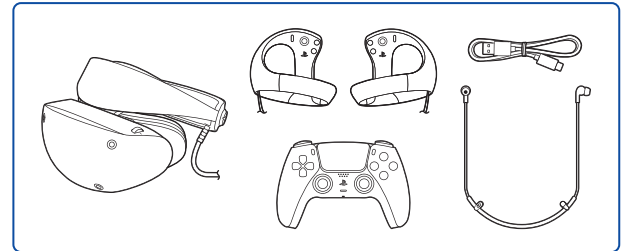

- ② Start by using the DualSense™ wireless controller included with your PS5 console, and follow the instructions displayed on your TV to complete setup.

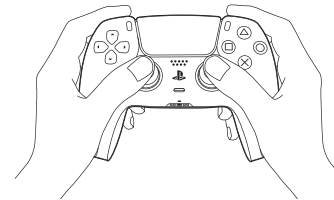

Use the PS VR2 Sense controller

- 1 Press the  (PS) button on each of the controllers to turn them on.

The status indicator on each of the controllers turns white.
If the status indicator doesn't turn on, charge the controller.

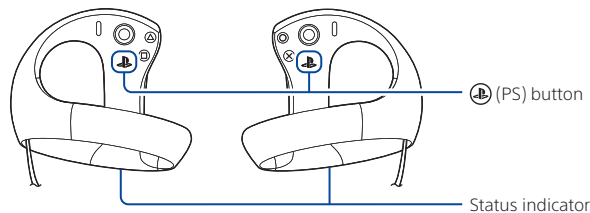

- 2 Check that you are correctly holding the left and right controllers, and wear the straps securely on your wrists.

You can identify the right (R) and left (L) controllers by looking at the strap holders.
Pass your hand through the loop, and pull the strap while rotating your wrist to secure the strap.

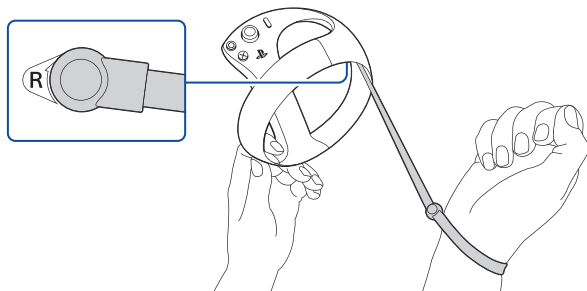

- 3 Hold the controllers.

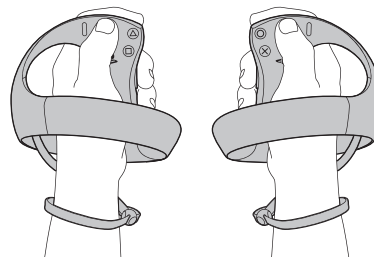

Remove the USB cable when you play.

Pair each of the controllers



If it's your first time using the controller, you'll need to pair it with your PS5 console. Turn on your PS5 console, and then in turn connect each of the controllers to your console using the USB cable.

Charge each of the controllers

Connect each of the controllers to your PS5 console using the USB cable while the console is on or in rest mode. During rest mode, the status indicator on each controller slowly blinks white, and then turns off when each controller is fully charged.

- To charge your controller while your console is in rest mode, start at your PS5 console's home screen, and then go to **Settings**  > **System** > **Power Saving** > **Features Available in Rest Mode** > **Supply Power to USB Ports**, and select an option other than **Off**.
- Use the USB cable provided with this product or with your PS5 console. When using other cables, be sure to use a USB cable that complies with USB standards. Not all USB cables will function properly.

Turn off the controller

Press the  (PS) button on the controller to display the control centre of your PS5 console. When you select **Accessories**  > **PS VR2 Sense Controller (L)** or **PS VR2 Sense Controller (R)** > **Turn Off**, the controller and its status indicator turns off.

Attach the straps

If a strap detaches from either of the controllers, use the following method to reattach it.
Align the raised part of the hook with the strap holder. Then, rotate the strap hook in the direction of the arrow until the strap locks into place.

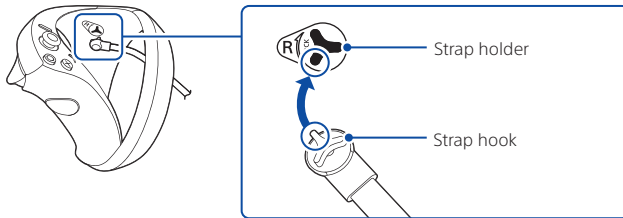

Remove your VR headset

Hold down the headband release button and pull back the headband to remove the VR headset.

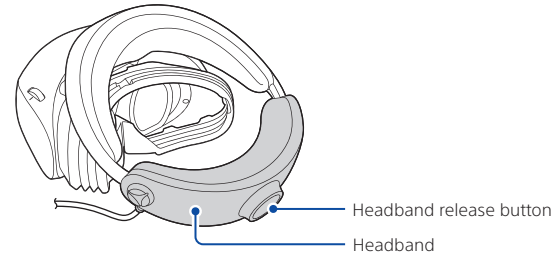

- When the VR headset is removed, the headset screen will turn off automatically.
- You can check how to wear the VR headset properly from your PS5 console's home screen by selecting **Settings**  > **Accessories** > **PlayStation VR2**.

Turn off your VR headset

Press and hold the  (power) button on the VR headset. The power indicator blinks white, and then turns red.

About PS VR2

Connect PS VR2 to your PS5 console and enjoy virtual reality (VR mode) in supported PS5 games. In cinematic mode, enjoy video content, PS5 games, and supported PS4™ games on a large screen in virtual space. When you're in cinematic mode and wearing the VR headset, video and audio are output to the VR headset only.

PS VR2 is not compatible with PlayStation®4 consoles and cannot play PS4 games in VR mode.

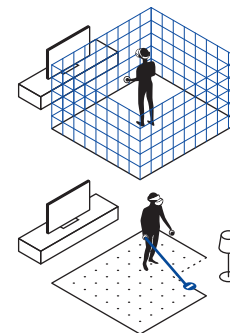

Play Area

- The area where you can safely play in VR mode while wearing the VR headset is called the Play Area. If you approach the edge of the area during gameplay, you'll see a boundary line in VR mode. If you move outside of the area, the game pauses and the screen changes to display your surroundings (see-through view). For your safety, do not leave the Play Area during gameplay.
- The tracking camera on the VR headset scans the room to set the Play Area. You can also expand or exclude parts of the area. Always follow all on-screen instructions for setting up and safely playing in your Play Area.



Play styles

- There are three types of postures and movements when playing in VR mode, which are VR play styles. When you purchase games or apps, check which VR play style is supported.

 Roomscale	Move around and play A Play Area of 2 m × 2 m or larger is required.
 Standing	Stand and play
 Sitting	Sit and play

- Sit in cinematic mode. Play Areas are deactivated in cinematic mode, so you won't see any boundary lines or messages when you move outside of the area.

See-through view



PS VR2 includes a see-through view that allows you to check your surroundings while you wear the VR headset. Press the  (function) button on the VR headset during gameplay to switch the display.

The display also automatically switches to the see-through view in the following cases.

- When you set the Play Area
- When you move outside of the Play Area during gameplay

Set up PS VR2

VR headset settings

You can configure your VR headset settings, including the Play Area and  (function) button assignments. Select your account as a PS VR2 user, then from the PS5 console's home screen, select **Settings**  > **Accessories** > **PlayStation VR2**. These settings are displayed only when the VR headset is on and connected to your PS5 console.

Settings for children

Parents and guardians can restrict usage by children as necessary. From the PS5 console's home screen, select **Settings**  > **Family and Parental Controls** and set restrictions for each child.

For details about the settings, refer to the User's Guide for the PS5 console ( page 22).

Part names

VR headset

Front

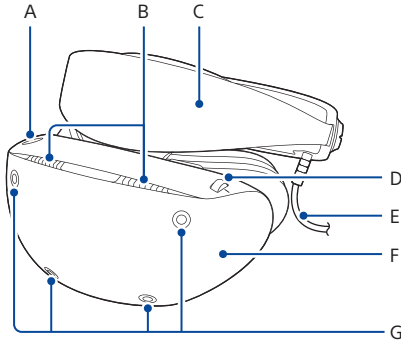

- A) Scope adjustment button
- B) Vent
- C) Headband
- D) Lens adjustment dial
- E) VR headset cable
- F) Scope
- G) Tracking cameras

Rear

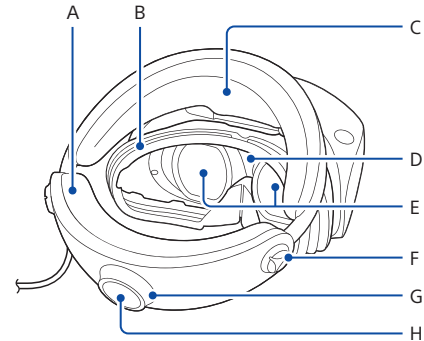

- A) Rear head support
- B) Light shield
- C) Front head support
- D) Attachment sensor
- E) Lenses
- F) Earpiece holder
When you're not using your headphones, use the earpiece holders to store them out of the way.
- G) Headband adjustment dial
- H) Headband release button

Bottom

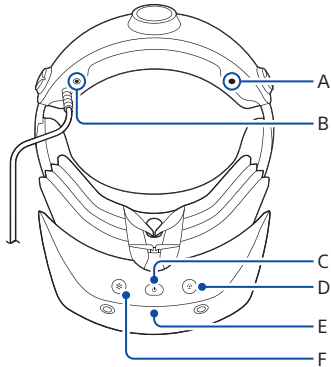

- A) Headphone attachment hole
- B) Stereo headphone jack
- C) ⏻ (power) button
Press: Turn on the VR headset
Press and hold: Turn off the VR headset
- D) Ⓜ (function) button
Press the button to switch to see-through view. You can mute the microphone by reassigning the button (→ page 13).
- E) Power indicator
Solid white: VR headset is on
Solid red: VR headset is off
- F) Microphone

Stereo headphones

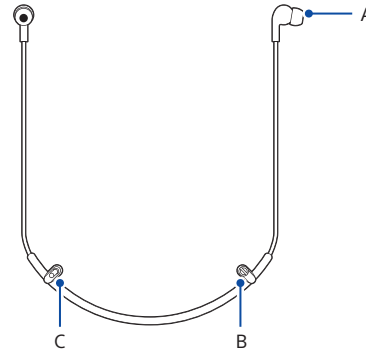

- A) Earpiece
- B) Fastener
- C) Stereo headphone plug

You can enjoy 3D audio with the included headphones as well as your own stereo headphones (analogue or USB). When you use headphones or headsets with a headphone jack, connect them to your VR headset. When you use USB headphones or headsets, connect them to your PS5 console.

Part names





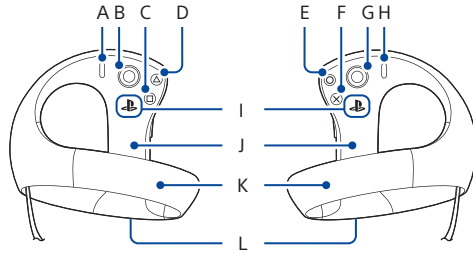

PS VR2 Sense controller

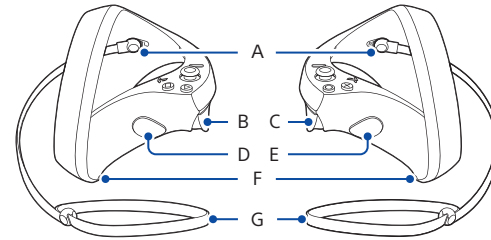
Top



Side



- A)  (create) button
- B) Left stick / L3 button
- C)  button
- D)  button
- E)  button
- F)  button
- G) Right stick / R3 button
- H)  (options) button
- I)  (PS) button
- J) Grip
- K) Tracking ring
- L) Status indicator
 - White, solid: On
 - White, slow blink: Charging in rest mode
 - Off: Off

- A) Strap holder
- B) L2 button
- C) R2 button
- D) L1 button
- E) R1 button
- F) USB port
- G) Strap

Use and handling

Never disassemble or modify the product or accessories

Use the product and accessories according to the instructions in this manual. No authorisation for the analysis or modification of the product, or the analysis and use of its circuit configurations, is provided. Unauthorised modification of the product will void your manufacturer's guarantee.

Tracking

PS VR2 detects head and hand movements with a tracking camera on the VR headset and a tracking mechanism embedded in the tracking ring on each of the controllers. Do not put stickers on the tracking camera or the tracking ring, or cover them with a cloth or your hands.

Handling the controller

- Charge in an environment where the temperature range is between 10 °C and 30 °C. Charging may not be as effective when performed in other environments.
- The batteries have a limited lifespan. Battery duration will gradually decrease with repeated usage and age. Battery life also varies depending on the storage method, usage state, environment, and other factors.
- When the controller is not used for an extended period of time, it is recommended that you fully charge it at least once a year in order to maintain battery functionality.

Headphones

Pull the headphone plug straight out when you remove the headphones. Do not pull it at an angle.

Changing the earpieces

The stereo headphones are supplied with M (medium) size earpieces attached. If they do not fit your ears, replace the earpieces with the S (small) or L (large) size earpieces for a better fit. To remove, twist then pull the earpiece off the headphones. Install the earpieces firmly to help prevent them from accidentally detaching during use.

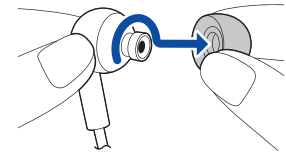

Care and cleaning

For your safety, remove the VR headset from your PS5 console and turn off the controller before cleaning.

Follow the precautions below to help prevent the product exterior from deteriorating or discolouring.

- Do not apply volatile substances such as insecticide.
- Do not allow rubber or vinyl materials to be in prolonged contact with the product.
- Do not use thinner, benzene, or alcohol. Avoid using wipes, chemically treated cloths, and other products that contain such substances.

VR headset surfaces and head supports, controller surfaces

Wipe with a soft, dry cloth.

Connectors and ports

Wipe with a soft, dry cloth.

You may experience noise or interruptions in the sound if the connectors on the headphones or headset are dirty.

Lenses

Wipe only with a soft, dry cloth made specifically for cleaning lenses. If stubborn dirt builds up on the lenses, wipe first with a slightly moistened cloth, then again with a dry cloth.

- Do not use paper products such as paper towels or tissues not specifically intended for lenses.
- Leaving water droplets or dirt on the lenses may cause deterioration or degradation.

Light shield

1 Remove the light shield from the VR headset.

Gently pull and wiggle the base at the right or left end of the light shield, and remove the light shield from the protrusions on the VR headset one by one in order.

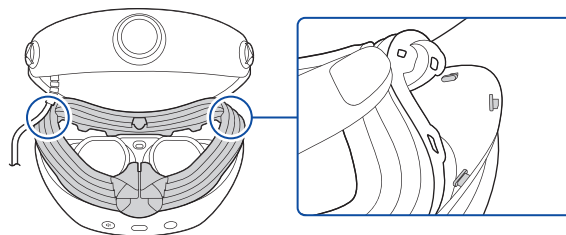

Be careful when removing or attaching the light shield, as it may break if you use excessive force.

2 Clean the light shield with water.

3 Wipe off the water with a soft, dry cloth. Before using, air dry the light shield well in a place with good ventilation.

4 Attach the light shield to the VR headset.

Insert the 14 protrusions on the VR headset into the holes of the light shield, and push the protrusion on the nose part of the light shield into the groove on the VR headset.

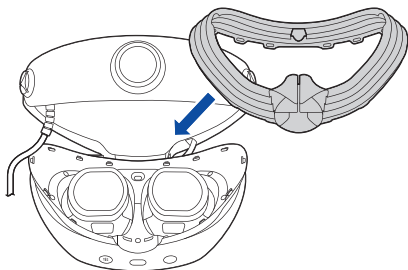

Vents

Remove dust build-up from the vents using a handheld vacuum cleaner or similar product.

Earpieces

Remove the earpieces from the stereo headphones and wash them by hand with a mild detergent. Dry them completely with a soft cloth before reattaching them to the headphones. For details on removing the earpieces, refer to "Changing the earpieces" (▶▶ page 17).

Specifications

Design and specifications are subject to change without notice. The operating instructions may vary depending on which software version you use, whether the system software of your PS5 console, or the device software of the VR headset and PS VR2 Sense controller. The actual product may vary from the illustrations in this manual.

PlayStation VR2

Screen	2 000 × 2 040 per eye
Sensor	6-axis motion sensing system (3-axis gyroscope, 3-axis accelerometer)
Cameras	Tracking camera × 4 (for VR headset, controller tracking) IR camera × 2 (for eye tracking)
Input/output	USB Type-C® connector
Audio	Input: Built-in microphone Output: Stereo headphone jack
Input power rating	12 V \approx 0.6 A
External dimensions	Approx. 212 × 158 × 278 mm (width × height × depth / excluding projecting parts / at shortest headband length)
Mass	Approx. 560 g (excluding cables)
Operating temperature	5 °C to 35 °C

End of life product recycling

The products are made of many materials that may be recycled. Each controller contains a lithium-ion battery. Follow local regulations when disposing of the products.

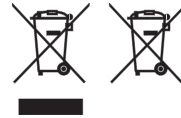

Where you see either symbol on any of our electrical products, batteries or packaging, it indicates that the relevant electrical product or battery should not be disposed of as general household waste in the EU, UK, Türkiye, or other countries with separate waste collection systems available. To ensure correct waste treatment, please dispose of them via an authorised collection facility, in accordance with any applicable laws or requirements. Waste electrical products and batteries may also be disposed of free of charge via retailers when buying a new product of the same type. Furthermore, within the UK and EU countries larger retailers may accept small waste electronic products free of charge. Please ask your local retailer if this service is available for the products you wish to dispose of. In so doing, you will help to conserve natural resources and improve standards of environmental protection in treatment and disposal of electrical waste. This symbol may be used on batteries in combination with additional chemical symbols.

The chemical symbol for lead (Pb) will appear if the battery contains more than 0.004% lead.

This product contains a battery which is permanently built-in for safety, performance or data integrity reasons. The battery should not need to be replaced during the lifetime of the product and should only be removed by skilled service personnel. To ensure the correct waste treatment of the battery, please dispose of this product as electrical waste.

PlayStation VR2 Sense controller

Input power rating	5 V \approx 700 mA
Battery type	Built-in lithium-ion battery
Battery voltage	3.7 V \approx
Battery capacity	520 mAh
Mass	Approx. 168 g
Operating temperature	5 °C to 35 °C

Supported video input signals

For information about supported video input signals, visit:



playstation.com/psvr2-video-input/

System and device software

- The device software of the VR headset and PS VR2 Sense controller are licensed to you under the terms of a separate end user license agreement. For details, visit <https://www.playstation.com/legal/ssla-ps-vr2/>
- Always update the system software of your PS5 console and the device software of the VR headset and PS VR2 Sense controller to the latest version.

Compliance information



The PlayStation VR2 Sense controllers have been tested and found to comply with the limits set out in the EU RE Directive and UK RE Regulation. Only use cables that are either a) supplied with the equipment, b) official PlayStation accessories or c) less than 3 metres in length.

This product has been manufactured by or on behalf of Sony Interactive Entertainment Inc., 1-7-1 Konan Minato-ku Tokyo, 108-0075 Japan.

Imported into the United Kingdom and distributed by Sony Interactive Entertainment Europe Limited, 10 Great Marlborough Street, London, W1F 7LP, United Kingdom.

Inquiries related to product compliance in the UK should be sent to the manufacturer's authorised representative, Sony Europe B.V., The Heights, Brooklands, Weybridge, Surrey KT13 0XW, United Kingdom.

Imported into Europe and distributed by (except the UK) Sony Interactive Entertainment Ireland Limited, 2nd Floor, 2/3 Rogers Lane, Dublin 2, Ireland.

Inquiries related to product compliance in the EU should be sent to the manufacturer's authorised representative, Sony Belgium, bijkantoor van Sony Europe B.V., Da Vincilaan 7-D1, 1930 Zaventem, Belgium.

RE Directive “Informal DoC” statement

Hereby, Sony Interactive Entertainment Inc., declares that the PlayStation VR2 Sense controllers are in compliance with the essential requirements and other relevant provisions of Directive 2014/53/EU. For details, please access the following URL: <https://compliance.sony.eu>

UK RE Regulation “Informal DoC” statement

Hereby, Sony Interactive Entertainment Inc., declares that the PlayStation VR2 Sense controllers are in compliance with the relevant statutory requirements. For details, please access the following URL: <https://compliance.sony.co.uk>

The frequencies used by the wireless networking feature of this product are the 2.4 GHz (Bluetooth®) range.

Wireless frequency band and maximum output power:

– Bluetooth® 2.4 GHz: less than 10 mW.

Copyright trademarks

“PS”, “PlayStation”, “PS5”, “PS4”, “PlayStation VR2 Sense”, “DualSense” and “PlayStation Shapes Logo” are registered trademarks or trademarks of Sony Interactive Entertainment Inc.

“SONY” and “” are registered trademarks or trademarks of Sony Group Corporation.

The Bluetooth® word mark and logos are registered trademarks owned by Bluetooth SIG, Inc. and any use of such marks by Sony Interactive Entertainment Inc. is under license. Other trademarks and trade names are those of their respective owners.

USB-IF SuperSpeed USB Trident logo is a registered trademark of USB Implementers Forum, Inc.

USB Type-C® and USB-C® are registered trademarks of USB Implementers Forum.

All other trademarks are the property of their respective owners.

Further information

User’s Guide

Find out about everything your PS5 console can do. You can also find detailed information about your VR system’s functions and how to configure settings.

From your PS5 console’s home screen, go to **Settings**  > **User’s Guide, Health and Safety, and Other Information** > **User’s Guide**.

Customer Support Website

For online support information such as step-by-step troubleshooting and frequently asked questions, visit:



playstation.com/help/



© 2024 Sony Interactive Entertainment Europe Limited.

