





1

SONY



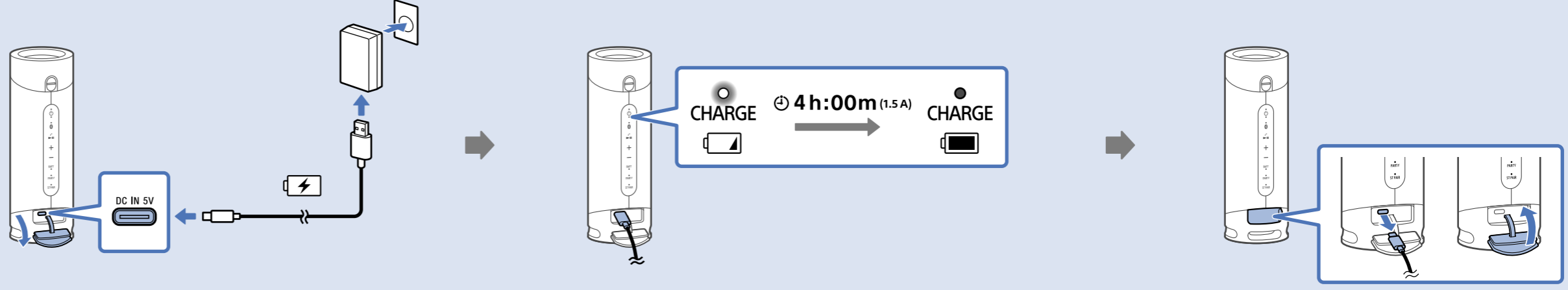



2



SRS-XB23

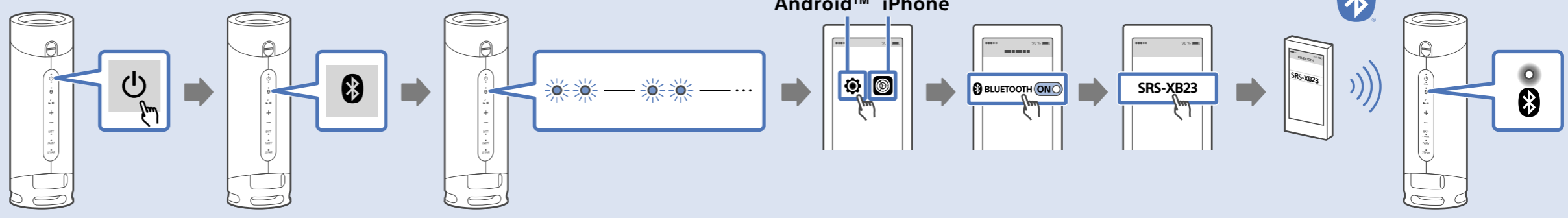

* 5 0 1 2 9 6 1 1 1 * (1)

3



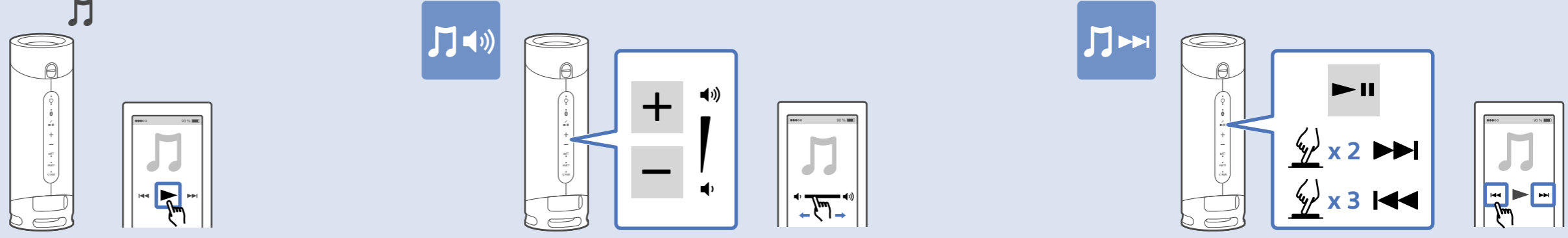

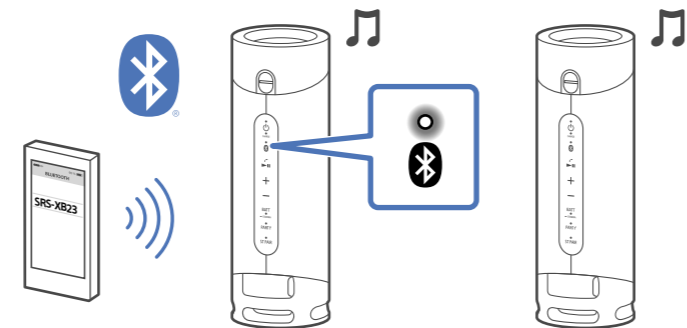
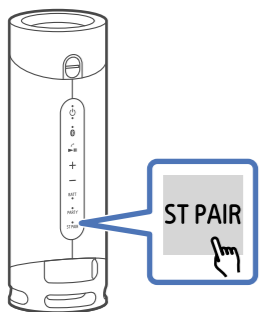
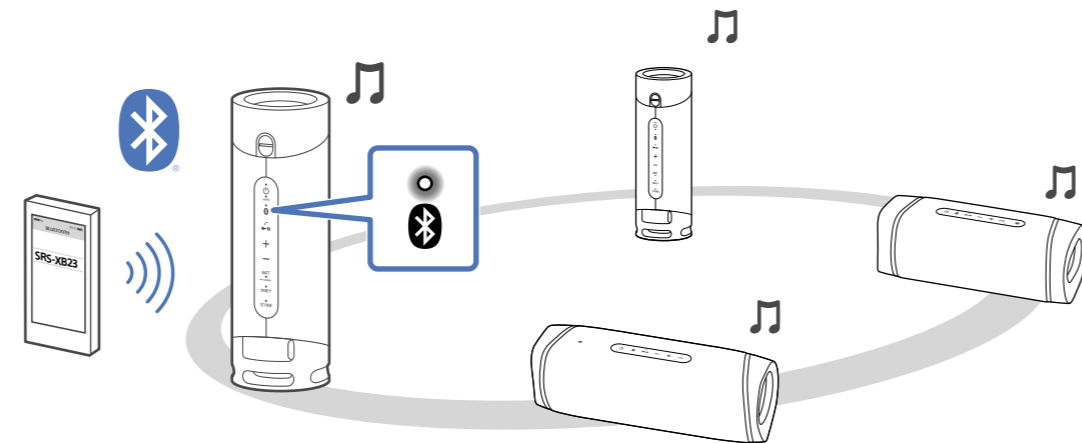
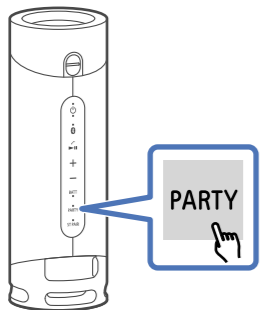
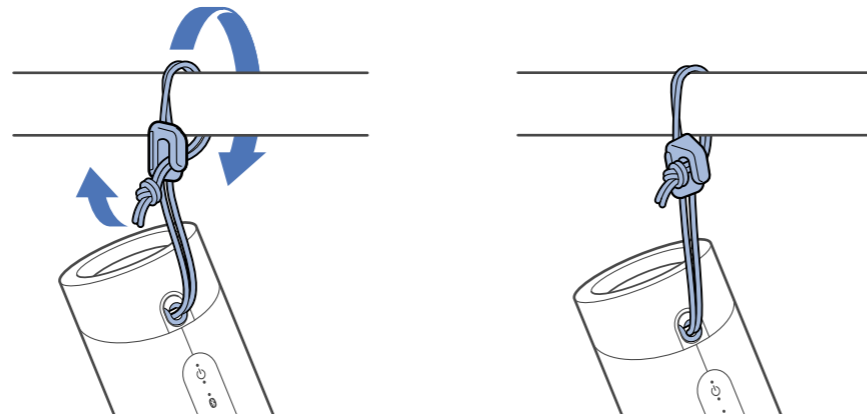
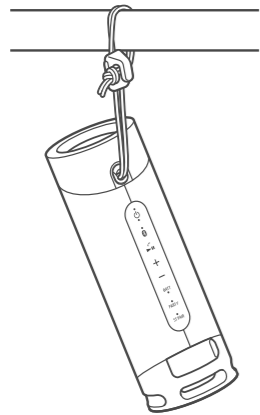

Android / iPhone

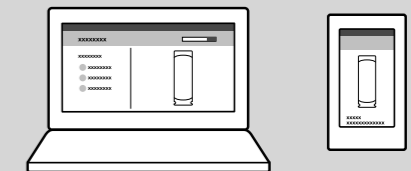

<https://www.sony.net/smcapp/>



https://rd1.sony.net/help/speaker/srs-xb23/h_zz/