

steelseries

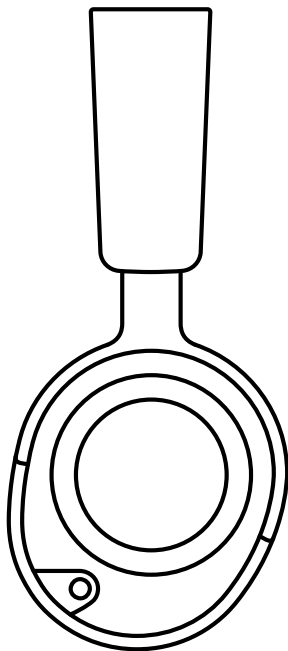

ARCTIS NOVA 1

PRODUCT INFORMATION GUIDE

TABLE OF CONTENTS

General	3
Product Overview	4
Setup	5
Microphone	6
Perfect Fit	7
Regulatory	8

GENERAL

PACKAGE CONTENTS

Arctis Nova 1 Headset

Main Headset Cable

Dual 3.5 mm Extension Cable

SYSTEM COMPATIBILITY

PC

Xbox

PlayStation 5

PlayStation 4

Nintendo Switch

SOFTWARE

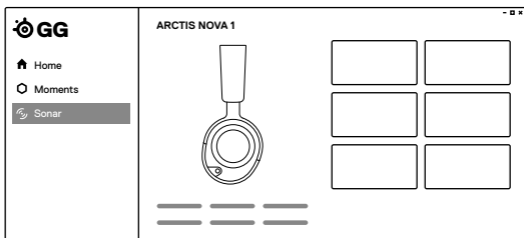

Use Engine inside SteelSeries GG to set custom equalizer settings and control your mic.

GG also has other amazing apps like Sonar, a breakthrough in gaming sound, that allows you to hear what matters most, through cutting-edge audio tools.



DOWNLOAD NOW

steelseri.es/gg

PRODUCT OVERVIEW

*Find accessories and replacement parts at steelseries.com/gaming-accessories

HEADSET

- 1 Elastic Headband
- 2 Airweave Ear Cushions*
- 3 Retractable ClearCast Microphone
- 4 Volume Wheel
- 5 Microphone Mute Button
- 6 3.5 mm Audio Jack

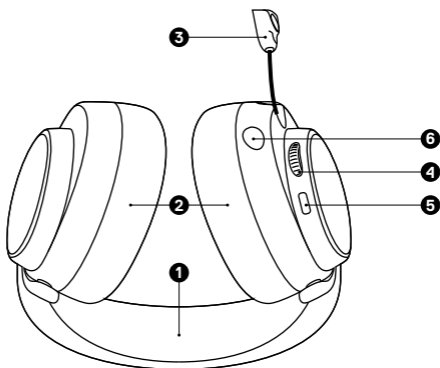

ACCESSORIES*

- 7 Main Audio Cable
- 8 Dual 3.5 mm Extension Cable

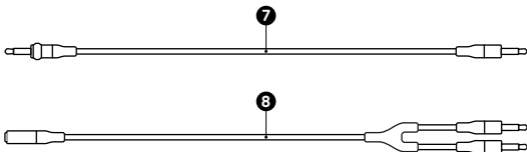

SETUP

SINGLE 3.5 MM CONNECTIONS

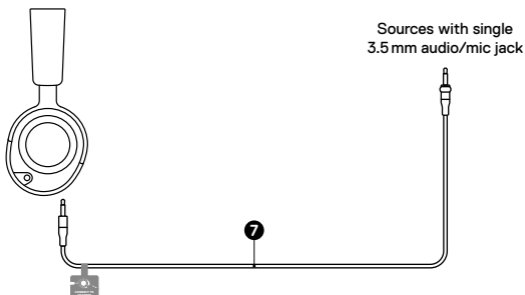

DUAL 3.5 MM CONNECTIONS

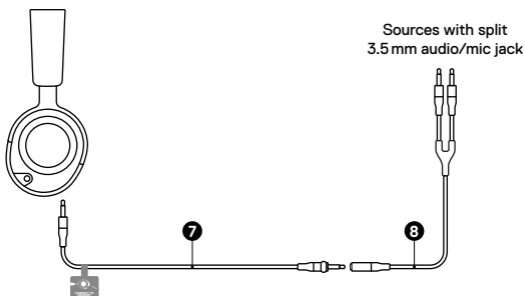

MICROPHONE

RETRACTABLE MICROPHONE

Out of the box, the **Retractable ClearCast Microphone (3)** is retracted. To use the microphone, slide it away from the headset until it reaches full extension.

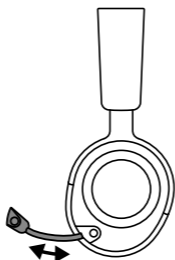

POSITIONING

Position the **Retractable ClearCast Microphone (3)** close to the corner of your mouth with the front surface facing you.

Note: The microphone should not be used when retracted.

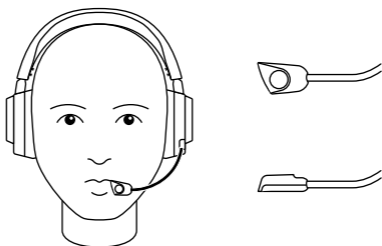

PERFECT FIT

There are two ways to adjust the fit of your headset

- 1 Slide the Earcups up or down to change the overall height.



- 2 Change the position of the **Elastic Headband (1)** on one or both sides to achieve the desired tension and flex.

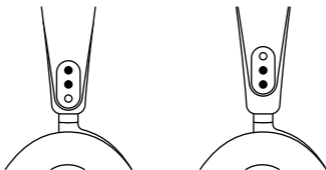

REGULATORY



Europe – EU Declaration of Conformity

Hereby, SteelSeries ApS. declares that the equipment which is compliance with directive RoHS 2.0 (2015/863/EU), EMC Directive (2014/30/EU), and LVD (2014/35/EU) which are issued by the Commission of the European Community.

The full text of the EU declaration of conformity is available at the following internet address: <https://steelseries.com/>

SteelSeries ApS. hereby confirms, to date, based on the feedback from our suppliers indicates that our products shipping to the EU territory comply with REACH (Registration, Evaluation, Authorization, and Restriction of Chemicals - (EC) 1907/2006) compliance program. We are fully committed to offering REACH compliance on the products and posting accurate REACH compliance status for the all of products.



UK Declaration of Conformity

Hereby, SteelSeries ApS. declares that the following equipment which is compliance with Electromagnetic Compatibility Regulations 2016, Electrical Equipment (Safety) Regulations 2016, Radio Equipment Regulations 2017 and The Restriction of the Use of Certain Hazardous Substances in Electrical and Electronic Equipment Regulations 2012 issued by the Department for Business, Energy& Industrial Strategy.

The full text of the UK declaration of conformity is available at the following internet address: www.steelseries.com



WEEE

This product must not be disposed of with your other household waste or treat them in compliance with the local regulations or contact your local city office, your household waste disposal service or the shop where you purchased the product.



Federal Communication Commission Interference Statement

This device complies with Part 15 of the FCC Rules. Operation is subject to the following two conditions:

This device may not cause harmful interference, and

this device must accept any interference received, including interference that may cause undesired operation.

This equipment has been tested and found to comply with the limits for a Class B digital device, pursuant to Part 15 of the FCC Rules. These limits are designed to provide reasonable

protection against harmful interference in a residential installation. This equipment generates, uses and can radiate radio frequency energy and, if not installed and used in accordance with the instructions, may cause harmful interference to radio communications. However, there is no guarantee that interference will not occur in a particular installation. If this equipment does cause harmful interference to radio or television reception, which can be determined by turning the equipment off and on, the user is encouraged to try to correct the interference by one of the following measures:

Reorient or relocate the receiving antenna.

Increase the separation between the equipment and receiver.

Connect the equipment into an outlet on a circuit different from that to which the receiver is connected.

Consult the dealer or an experienced radio/TV technician for help.

FCC Caution:

Any changes or modifications not expressly approved by the party responsible for compliance could void the user's authority to operate this equipment.

This transmitter must not be co-located or operating in conjunction with any other antenna or transmitter.

Industry Canada Statement

This device complies with Industry Canada license-exempt RSS standard(s). Operation is subject to the following two conditions:

this device may not cause interference, and

this device must accept any interference, including interference that may cause undesired operation of the device.

Le présent appareil est conforme aux CNR d'Industrie Canada

applicables aux appareils radio exempts de licence. L'exploitation est autorisée aux deux conditions suivantes:

l'appareil ne doit pas produire de brouillage, et

l'utilisateur de l'appareil doit accepter tout brouillage radioélectrique subi, même si le brouillage est susceptible d'en compromettre le fonctionnement.

This Class B digital apparatus complies with Canadian ICES-003.

Cet appareil numérique de la classe B est conforme à la norme NMB-003 du Canada.



该电子电气产品含有某些有害物质，在环保使用期限内可以放心使用，超过环保使用期限之后则应该进入回收循环系统。

《废弃电器电子产品回收处理管理条例》提示性说明

为了更好地关爱及保护地球，当用户不再需要此产品或产品寿命终止时，请遵守国家废弃电器电子产品回收处理相关法律法规，将其交给当地具有国家认可的回收处理资质的厂商进行回收处理。

Ukraine RoHS:

Обладнання відповідає вимогам Технічного регламенту щодо обмеження використання деяких небезпечних речовин в електричному та електронному обладнанні, затвердженого постановою Кабінету Міністрів України від 3 грудня 2008 № 1057

Restriction on Hazardous Substances statement (India)

This product complies with the "India E-waste Rule 2011" and prohibits use of lead, mercury, hexavalent chromium, polybrominated biphenyls or polybrominated diphenyl ethers in concentrations

exceeding 0.1 weight % and 0.01 weight % for cadmium, except for the exemptions set in Schedule 2 of the Rule.

根据中国大陆《电子电气产品有害物质限制使用标识要求》， 以下部分列出了产品中可能包含的有害物质的名称和含量：						
零部件名称	有害物质					
	铅 (Pb)	汞 (Hg)	镉 (Cd)	六价铬 (Cr(VI))	多溴联苯 (PBB)	多溴二苯醚 (PBDE)
电路板组件	×	○	○	○	○	○
其他线材	×	○	○	○	○	○
*电路板组件包括印刷电路板及其构成的零部件，如电阻、电容、集成电路、连接器等。						
本表格依据SJ/T 11364的规定编制。 ○：表示该有害物质在该部件所有均质材料中的含量均在 GB/T 26572规定的限量要求以下。 ×：表示该有害物质至少在该部件的某一均质材料中的含量超出GB/T 26572规定的限量要求； 上表中打“×”的部件，应功能需要，部分有害物质含量超出GB/T 26572规定的限量要求，但是符合欧盟RoHS 法规要求(属于豁免部分)。						

Region	Address	Telephone
Asia 亞洲	4F.-4, No. 186, Jian 1st Rd., Zhonghe Dist., New Taipei City 235603, Taiwan 新北市中和區建一路186號4樓及4樓之4	+886 2 8227 1999
Europe	Havneholmen 8, 1 st Floor, 2450 Copenhagen SV, Denmark	+45 702 500 75
USA	656 W Randolph St., Suite 3E, Chicago, IL 60661, USA	+1 312 258 9467

More information and support from steelseries.com



Direct Current

Product Name (產品名稱/产品名称): Headset (耳機/耳机)
 Model No. (型號/型号): HS-00027
 Rated (規格/规格): 3.5mm Audio Plug

Made in China (中國製造/中国制造)

Operating Temperature: 0 to + 40 °C

產品使用環境溫度: 0 - 40度



learn more at steelseries.com