

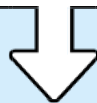

71387

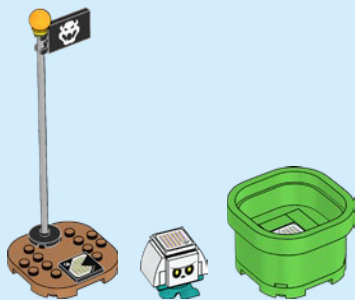

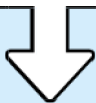

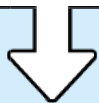
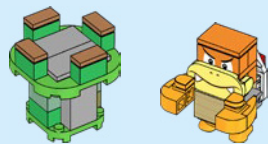
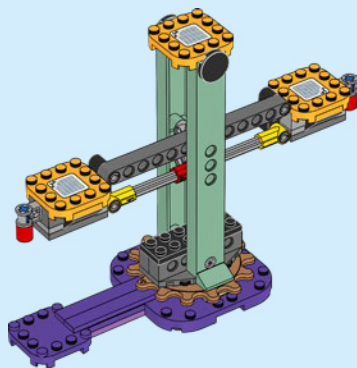
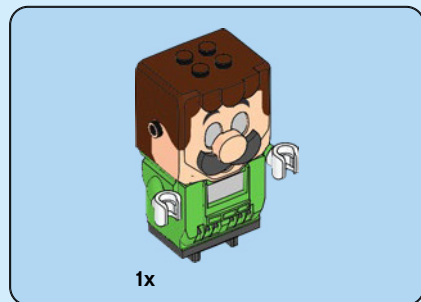
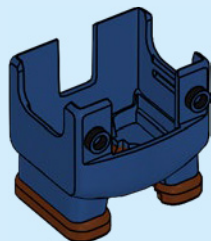
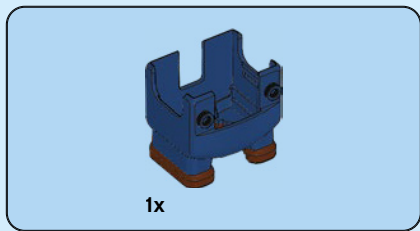
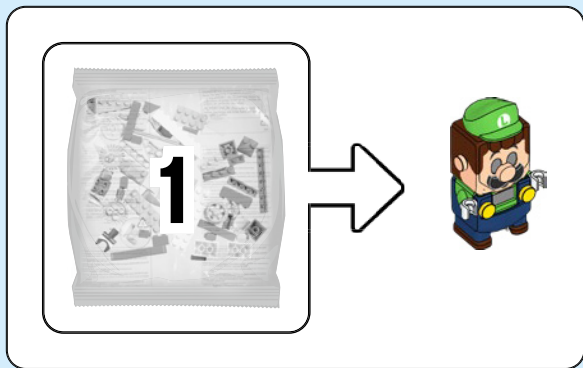

2



1

4



2x



2x

3

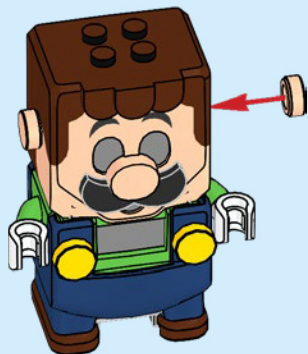

1x

4



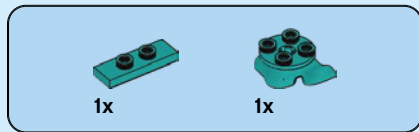
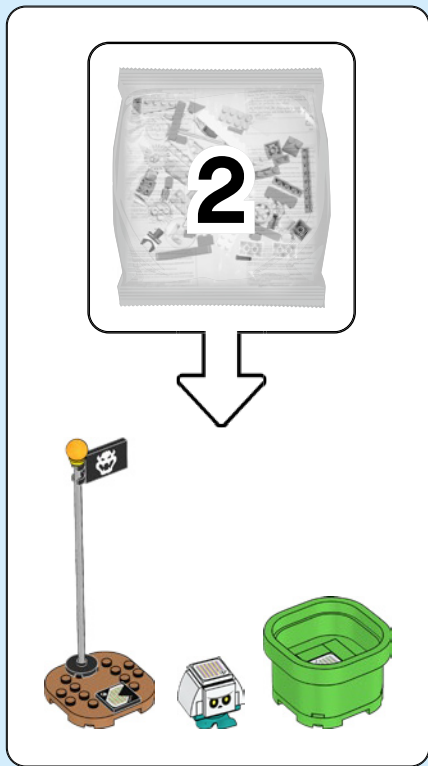

1

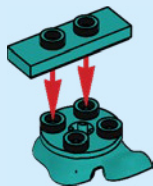



1x

2



2x

3

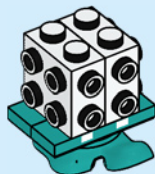

1x

4

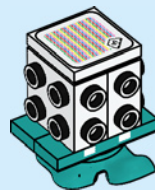



1x



1x

5

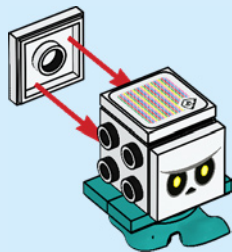

2x

6

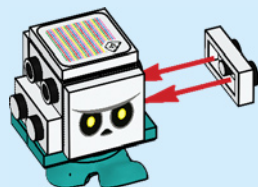

2x

7



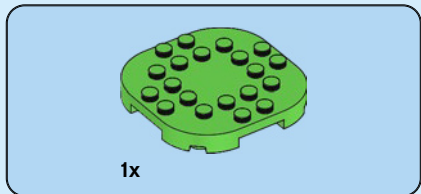

1

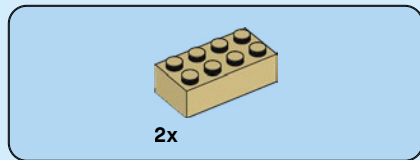
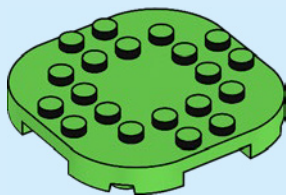

2

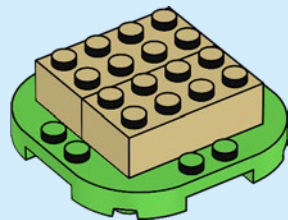

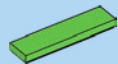

2x

3

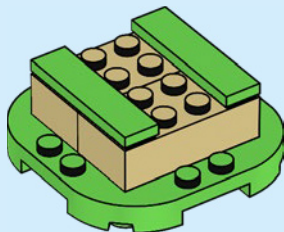

2x



1x

4

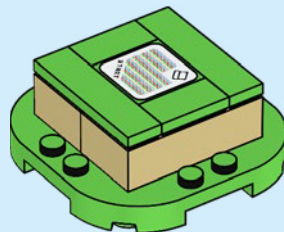

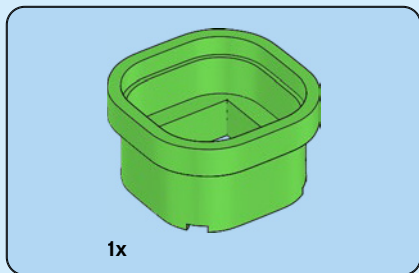

5

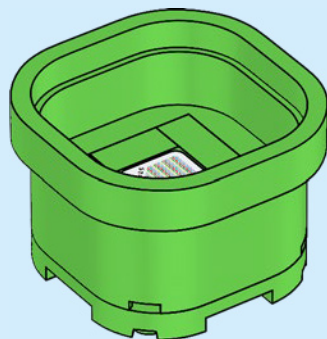

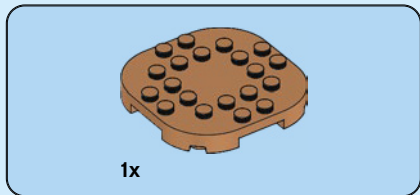

1

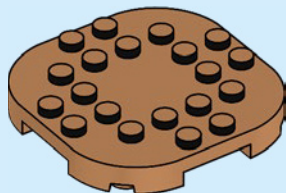

12

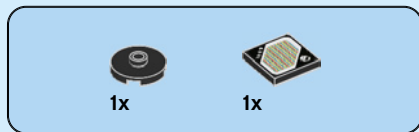

2

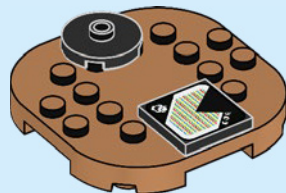

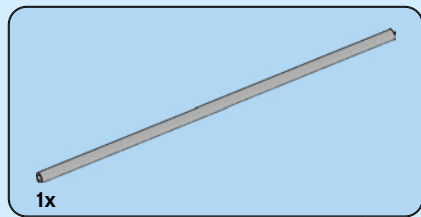

3

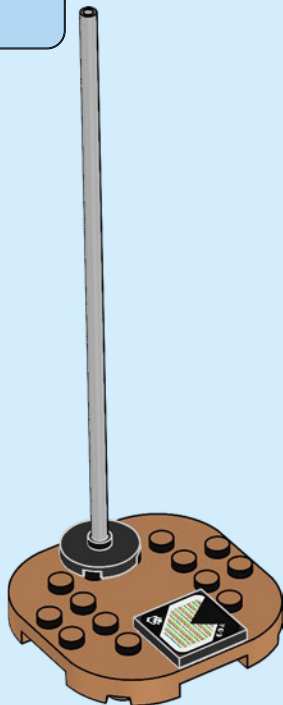

4

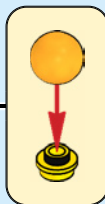
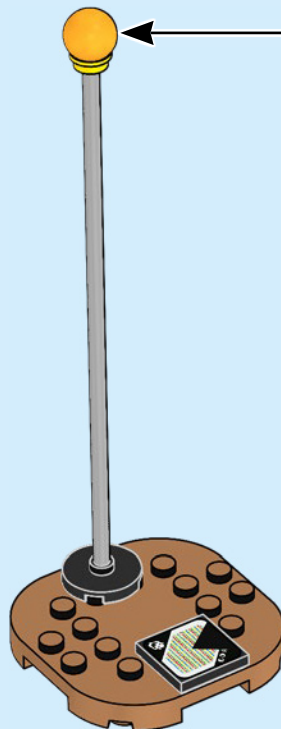



1x

5

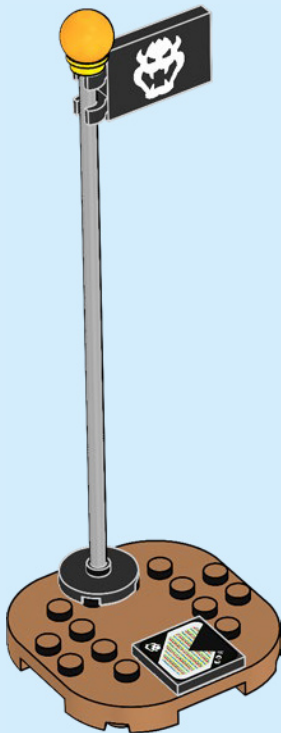

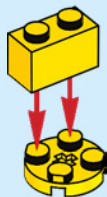
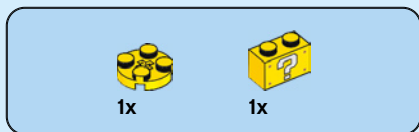
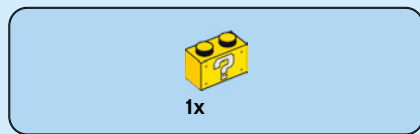
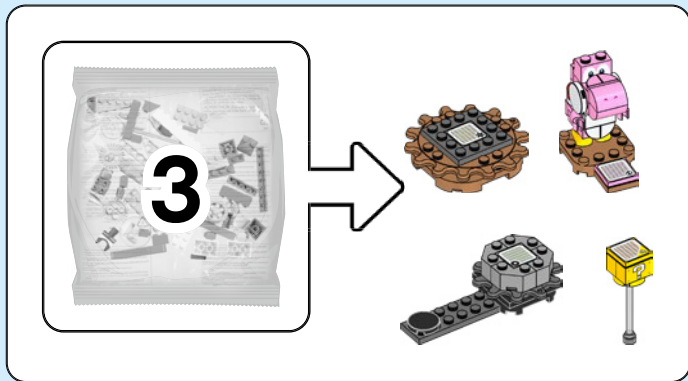



1x

3



1x

4

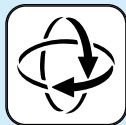

16



1x

5

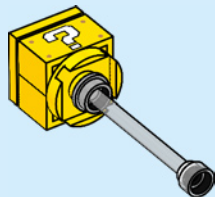

6

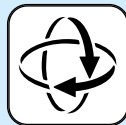

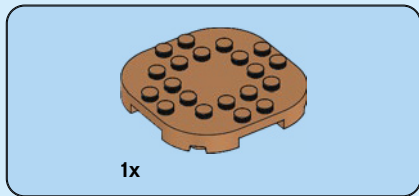

1

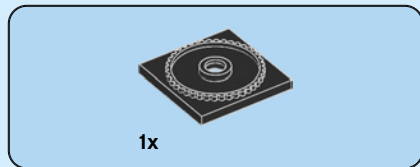
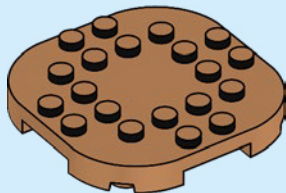

2

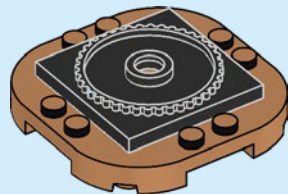

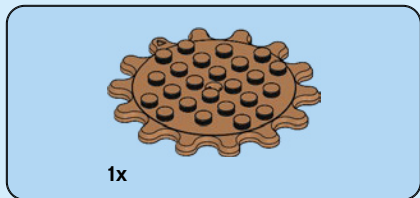

3

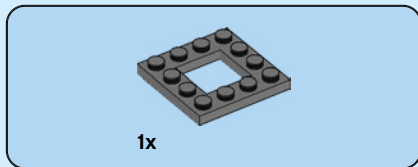
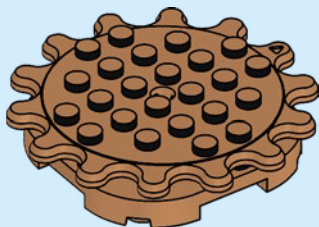

4

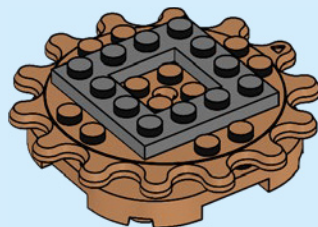



1x

5

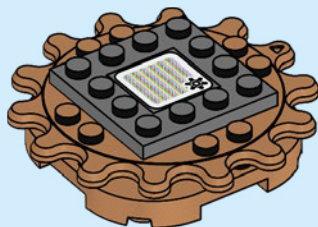

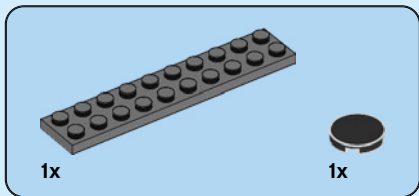
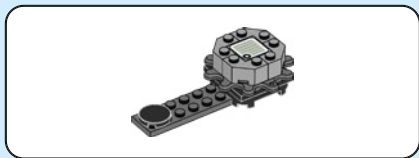

1

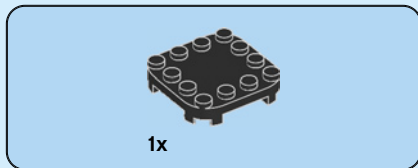
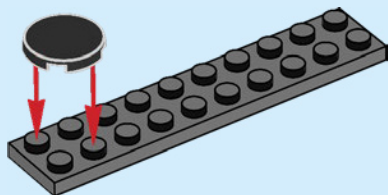

2

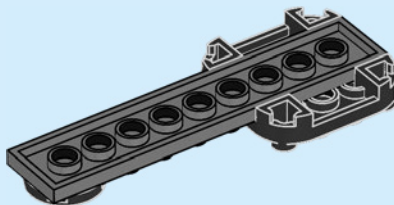
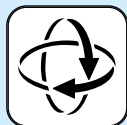

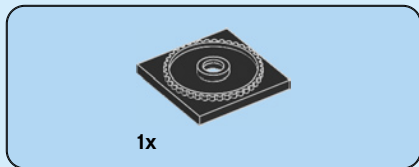

3

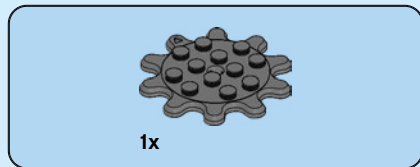
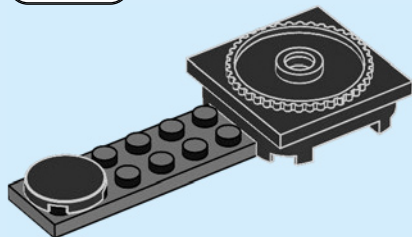

4

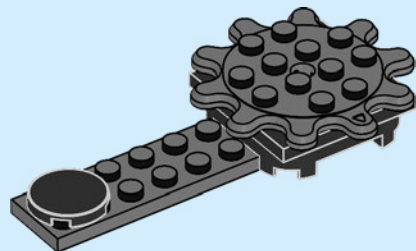



2x

5

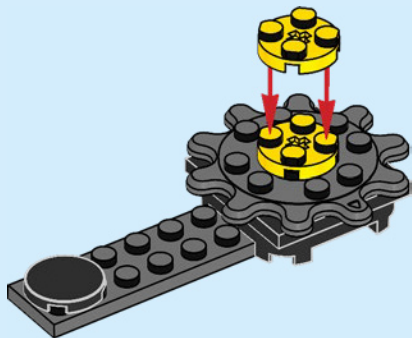

4x

6

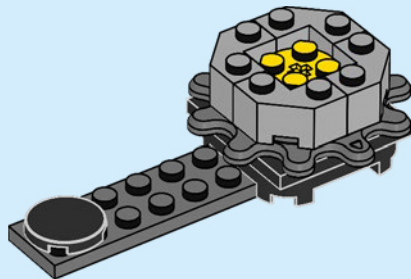



1

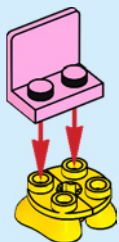

2

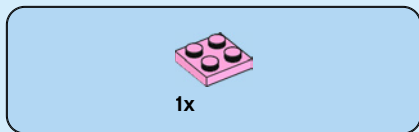

3

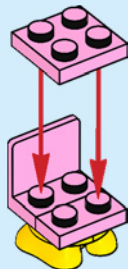

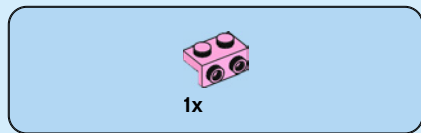

4

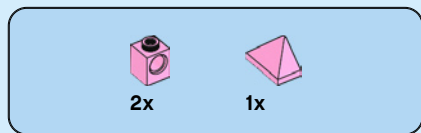

5

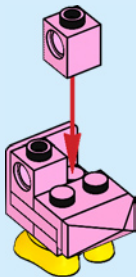

6

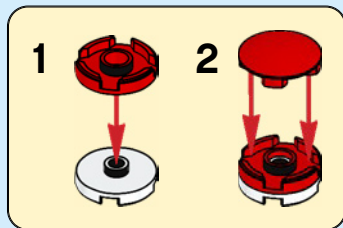



1x



2x

7

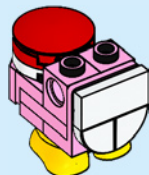
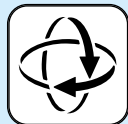

2x

8

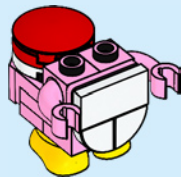

1x

9

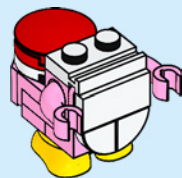

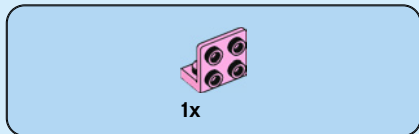

10

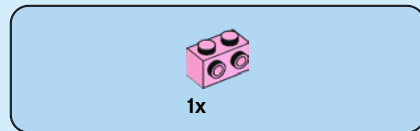

11

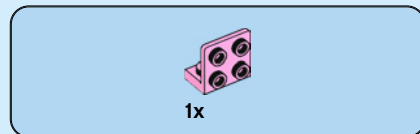
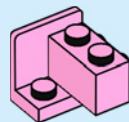

12

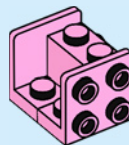



1x

13

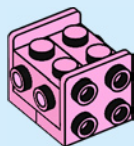

2x

14

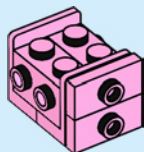

2x

15

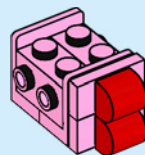

2x

16

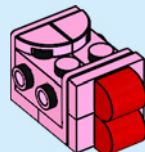



1x

17

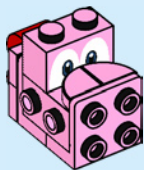

1x



1x

18

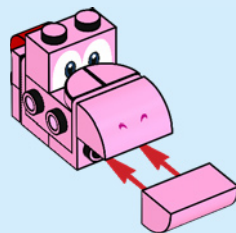

19

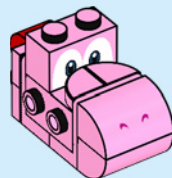

20

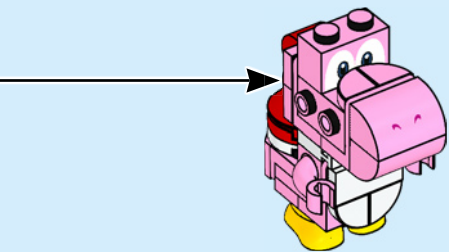

30

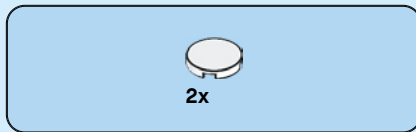

21

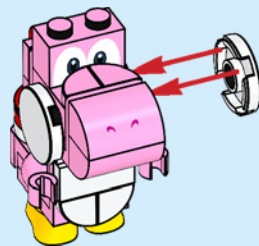

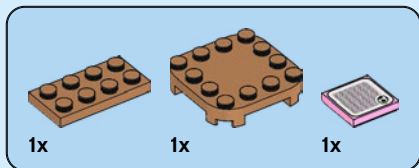

22

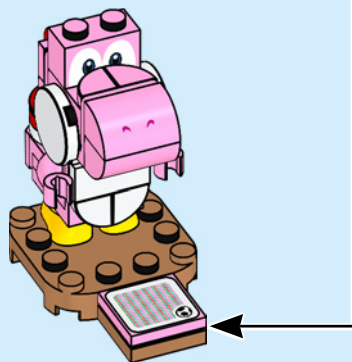
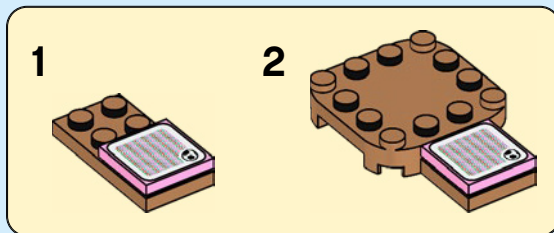

4

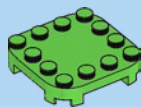
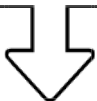

1x

1

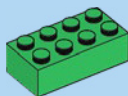
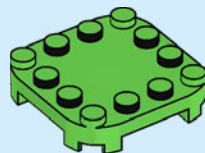

1x

2

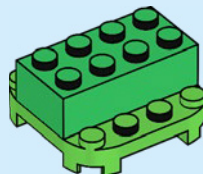



2x

3

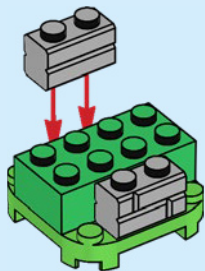

1x

4

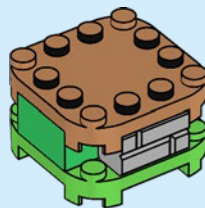

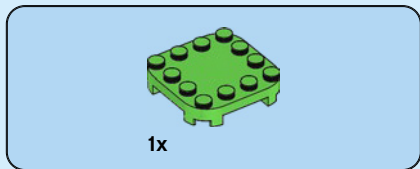
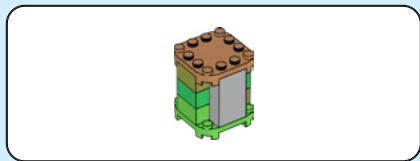

1

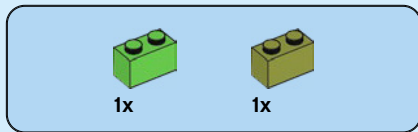
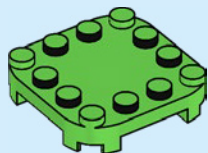

2

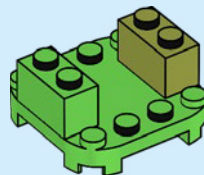

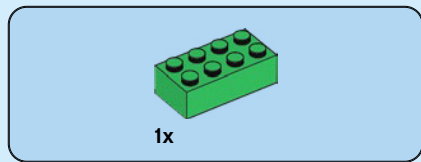

3

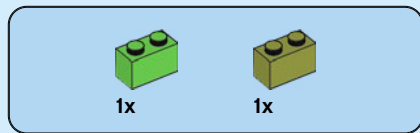
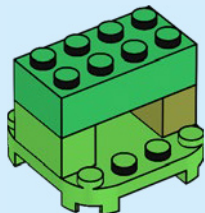

4

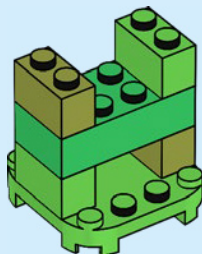

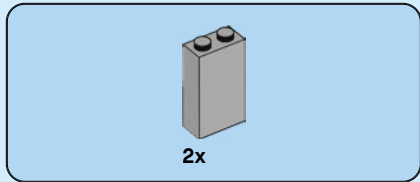

5

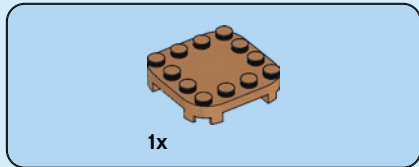
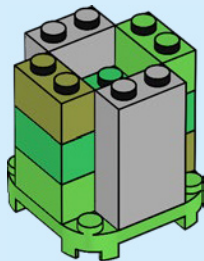

6

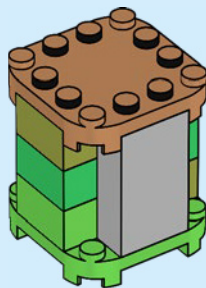

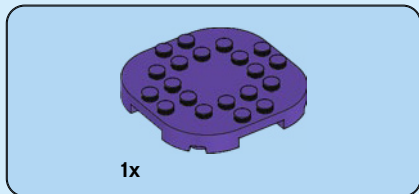
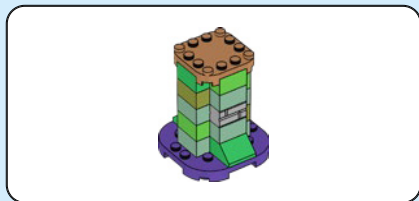

1

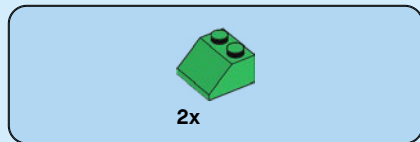
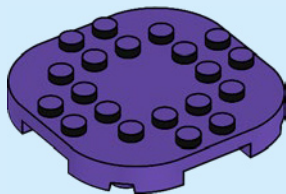

2

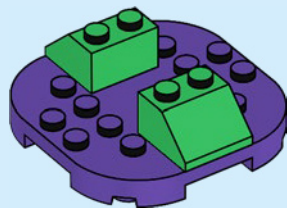

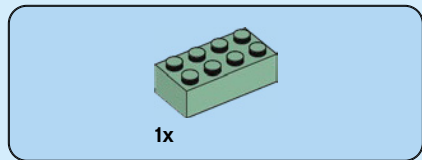

3

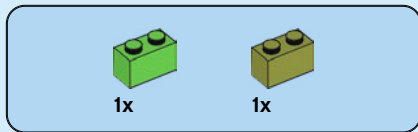
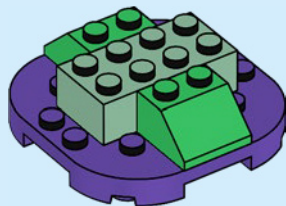

4

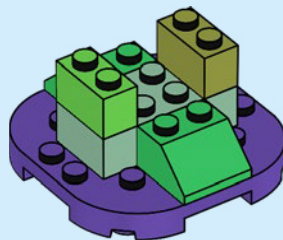

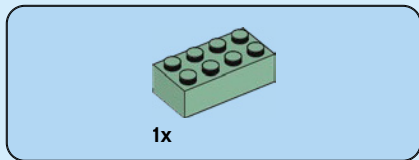

5

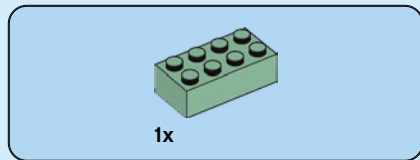
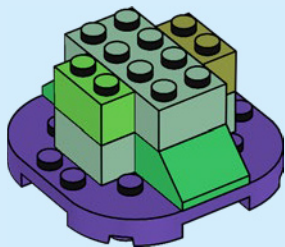

6

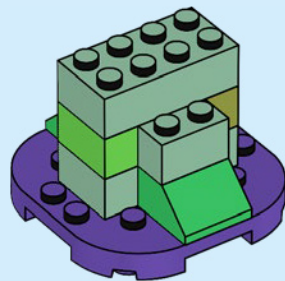



2x

7

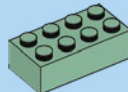
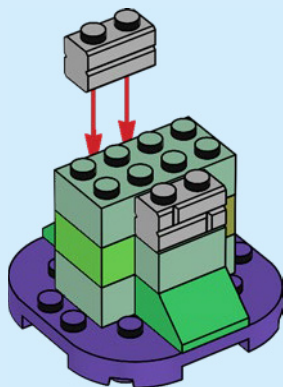

1x

8

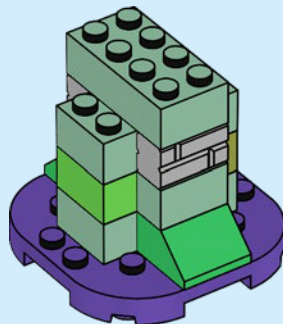



1x



1x

9

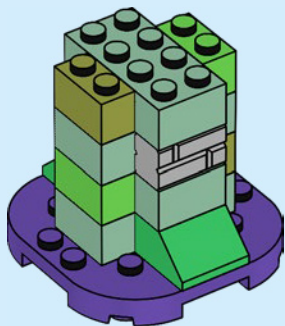

1x



1x

10

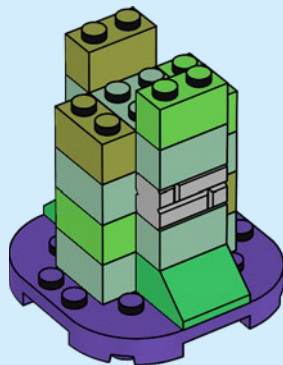

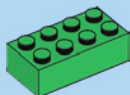

1x

11

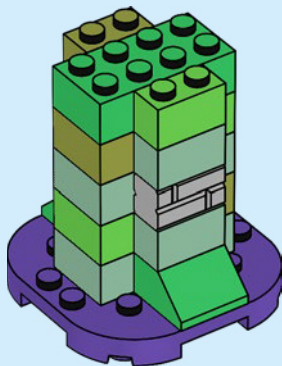

1x

12

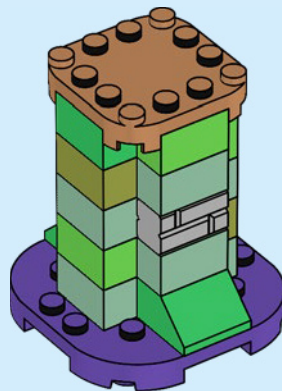

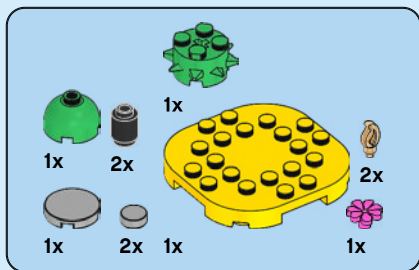

1

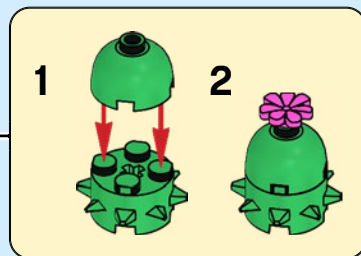
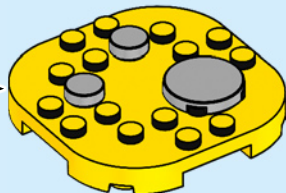
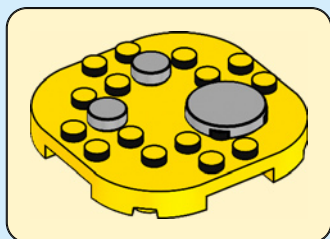
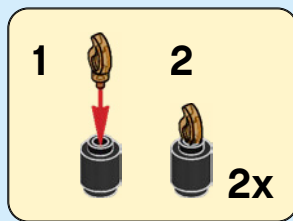

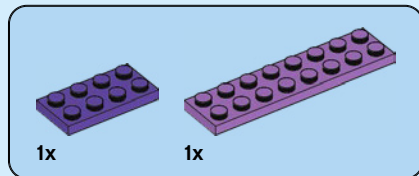
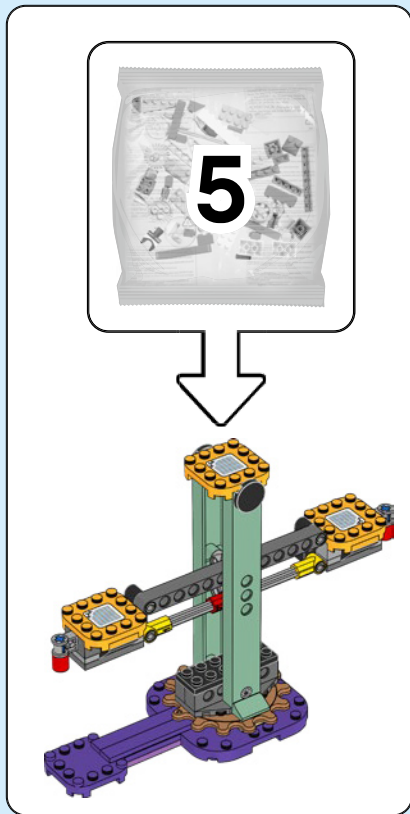

1

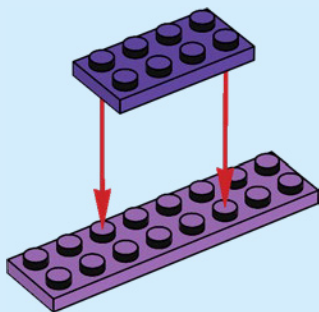

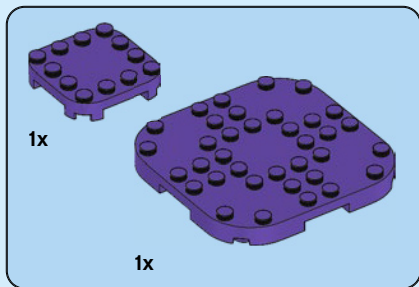

2

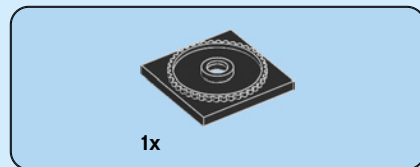
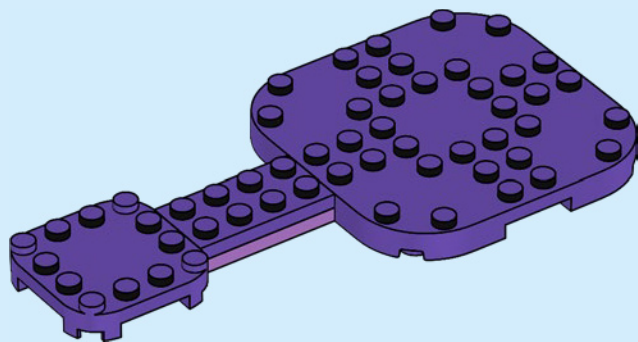

3

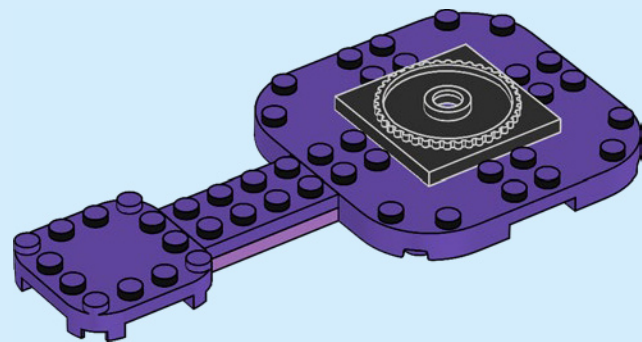

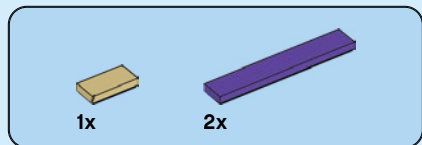

4

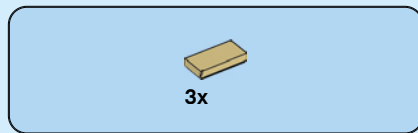
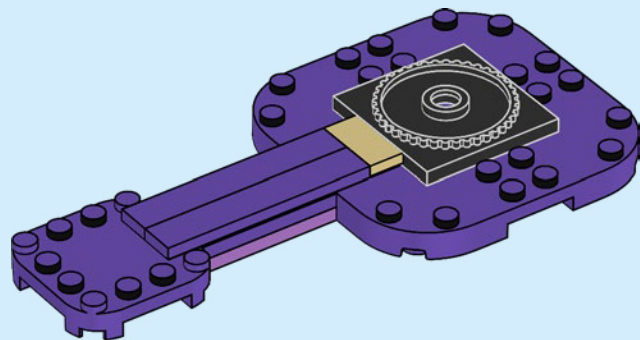

5

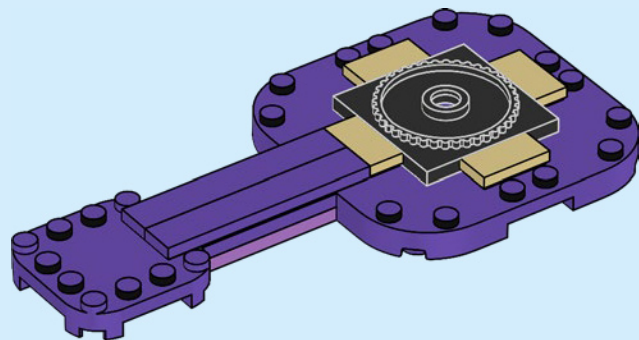

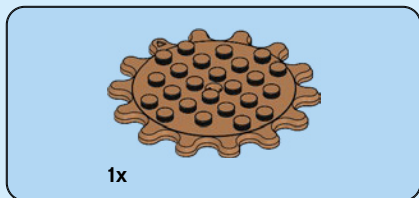

6

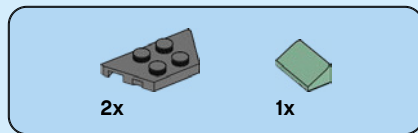
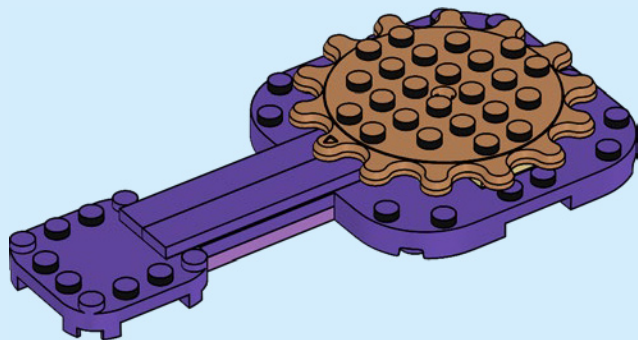

7

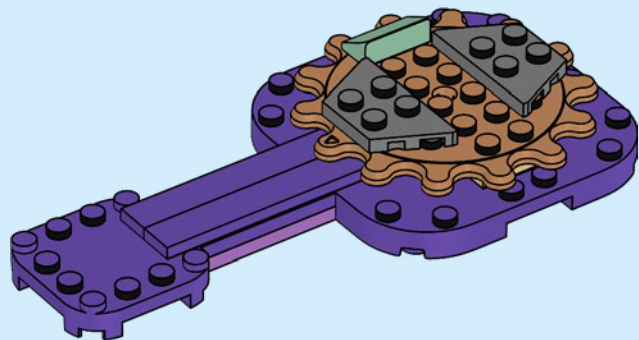

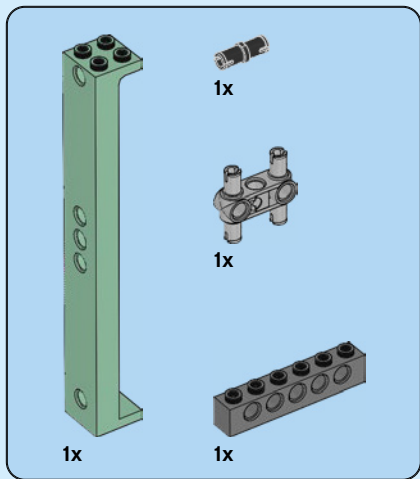

8

1

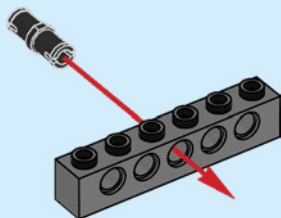

2

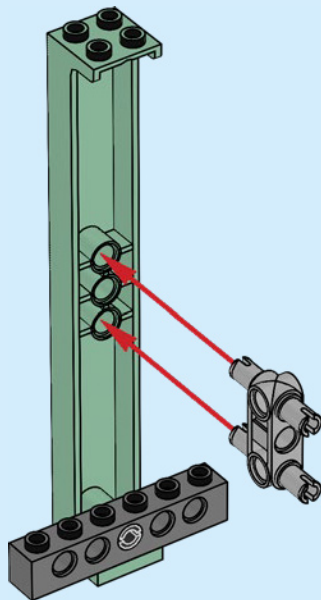

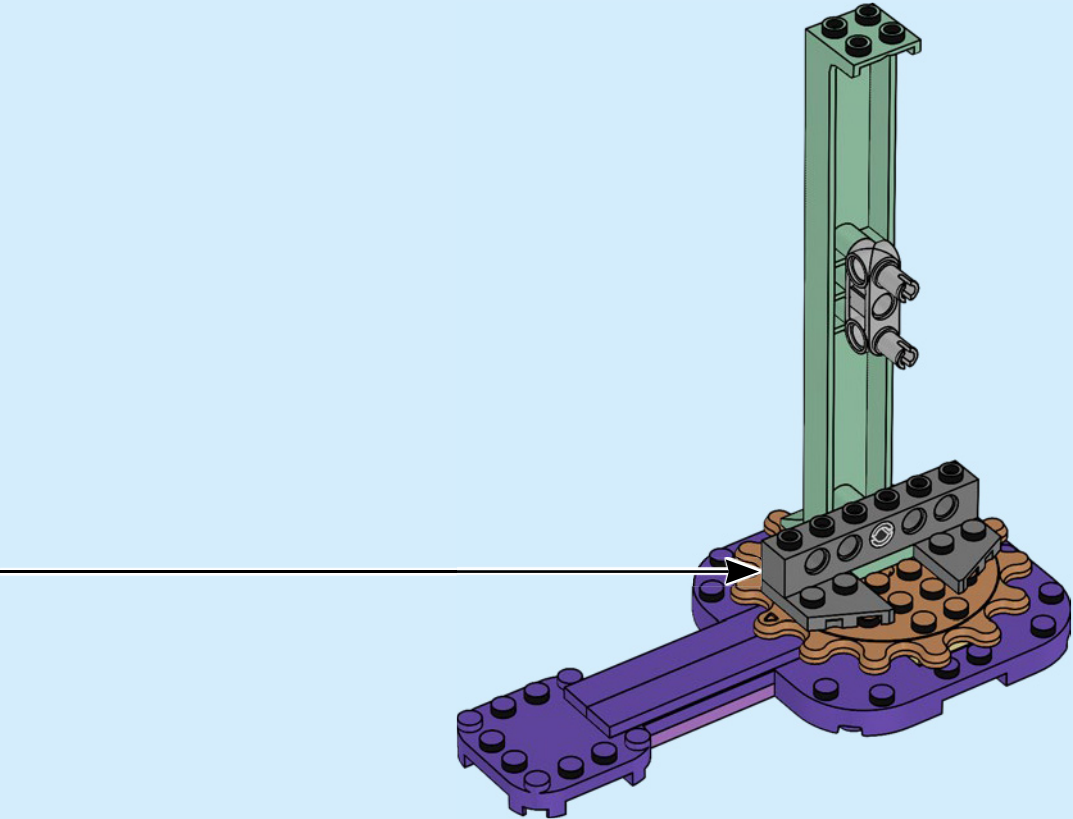

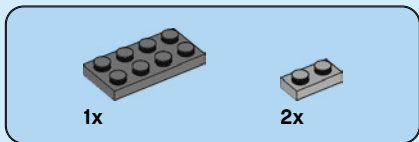
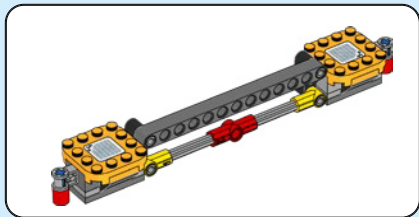

9

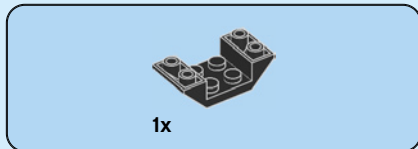
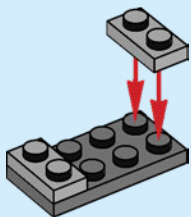

10

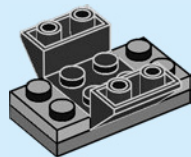

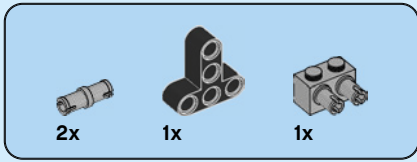

11

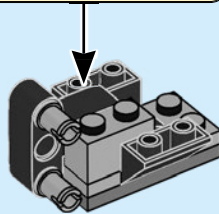
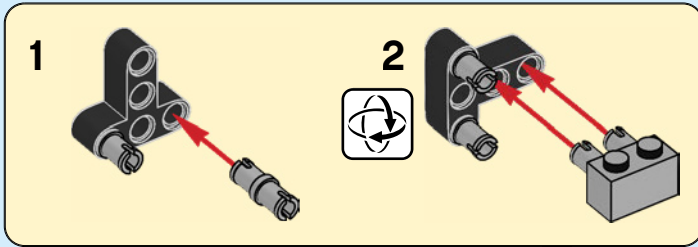



1x

12

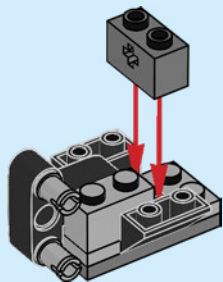

1x

13

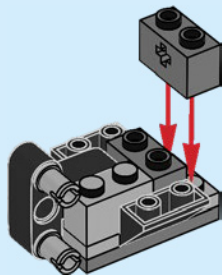

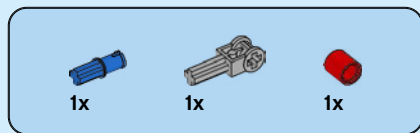

14

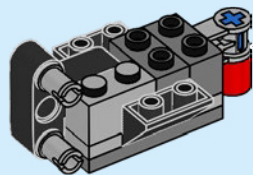
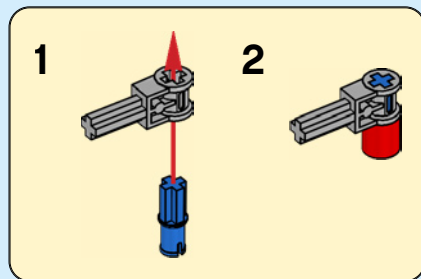

15

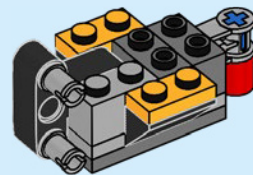

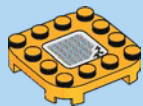

1x

16

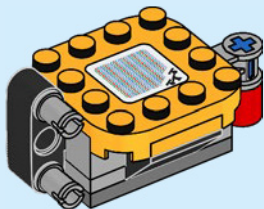

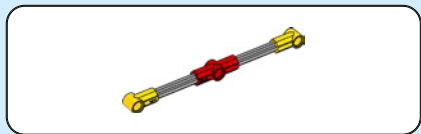

17

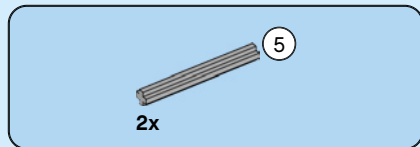

18

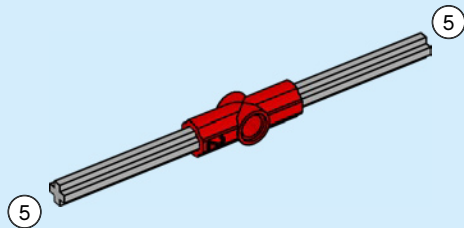



2x

19

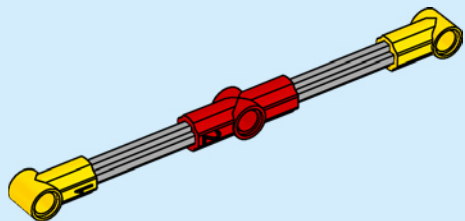

20

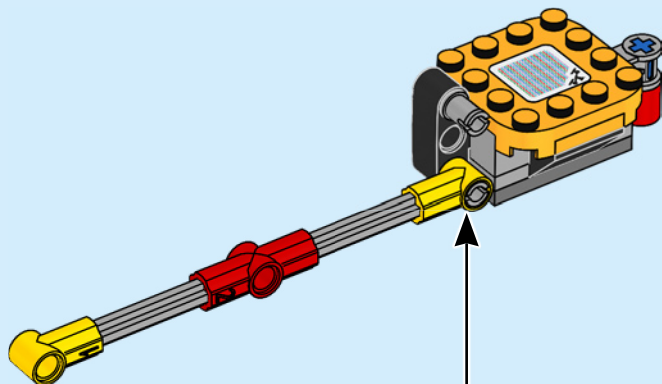

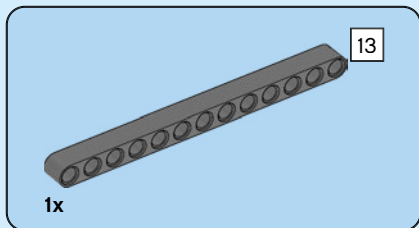

21

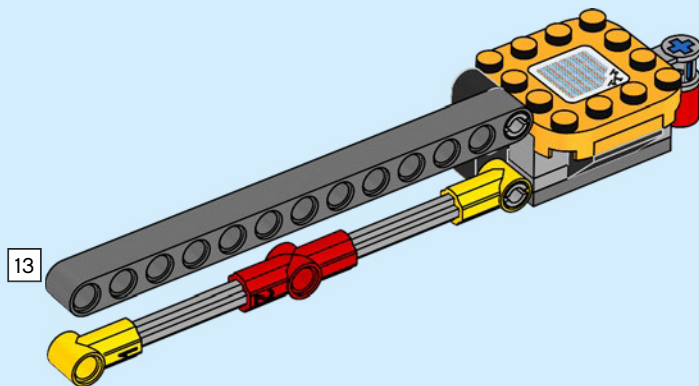

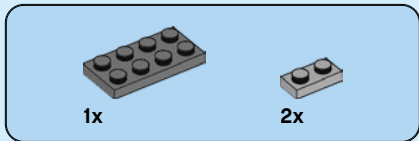

22

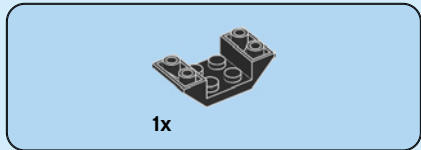
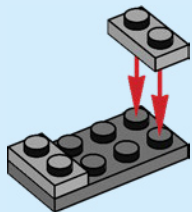

23

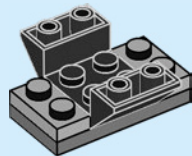

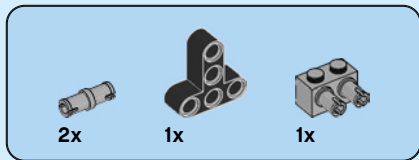

24

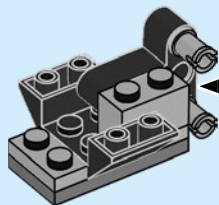
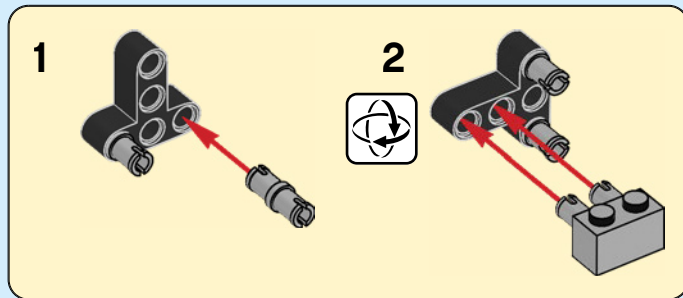



2x

25

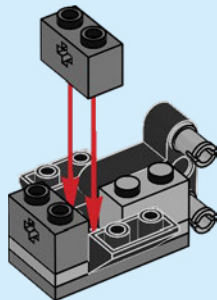

60



1x



1x



1x

26

1

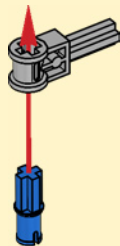

2

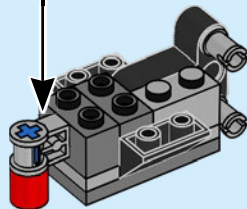
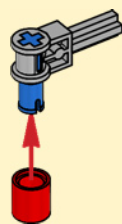



2x

27

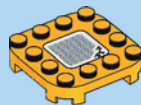
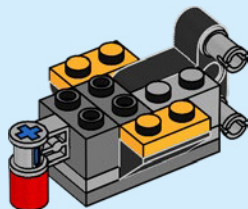

1x

28

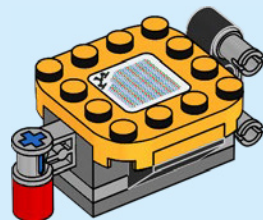

29

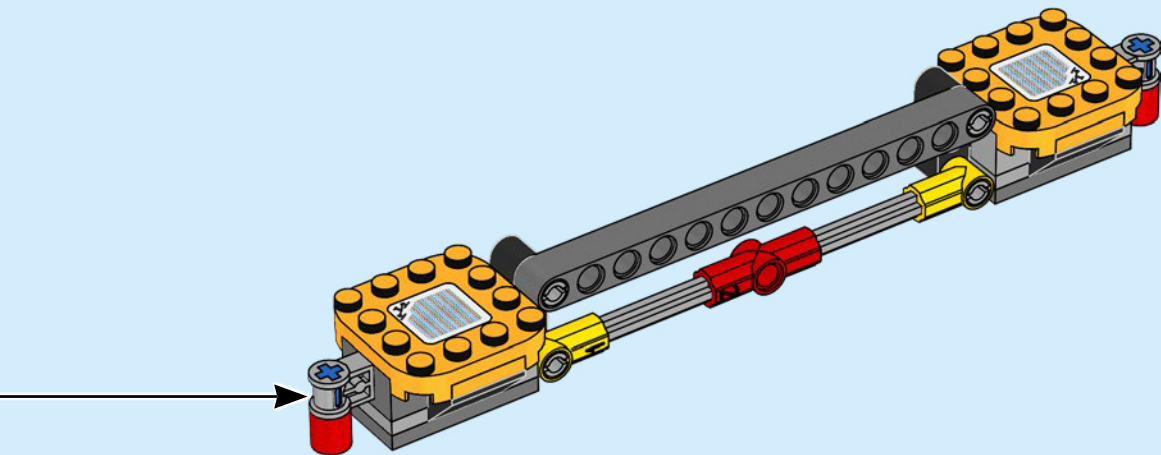

30

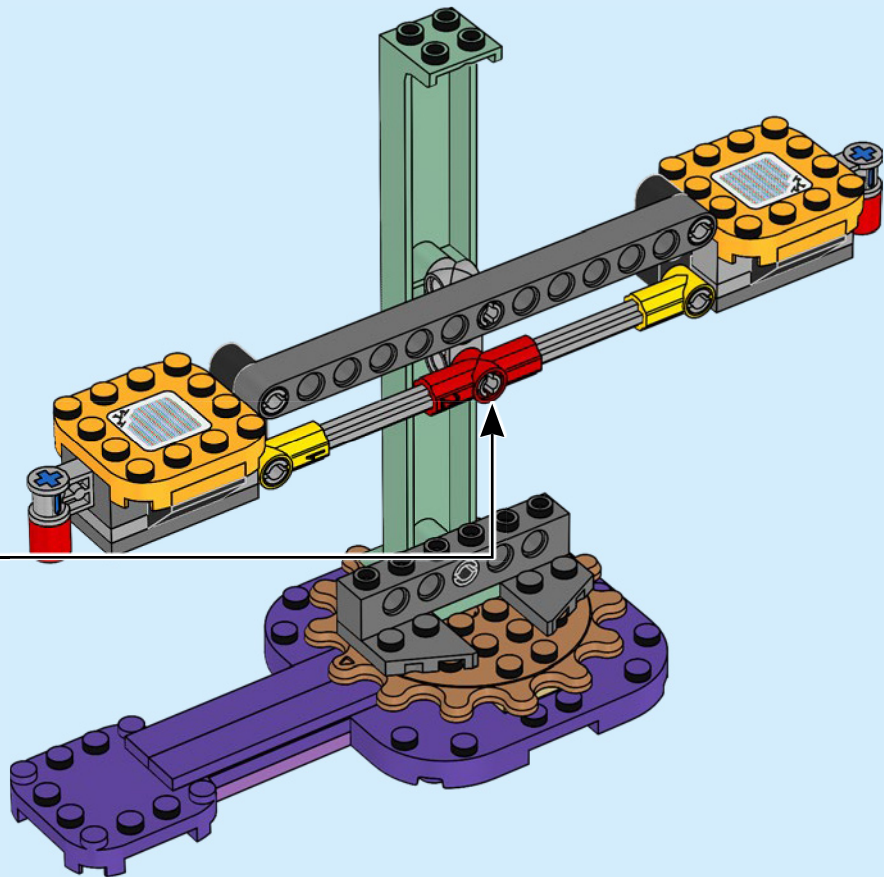

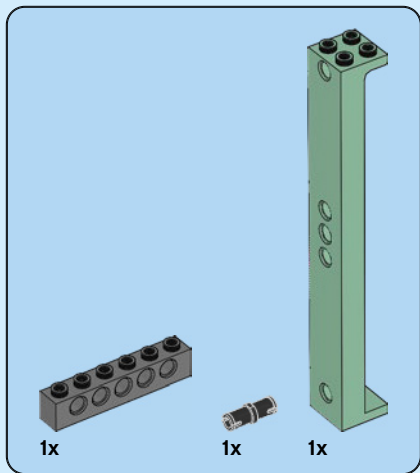

31

1

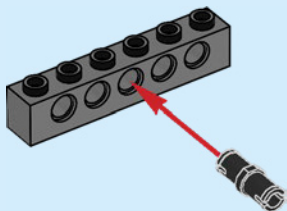

2

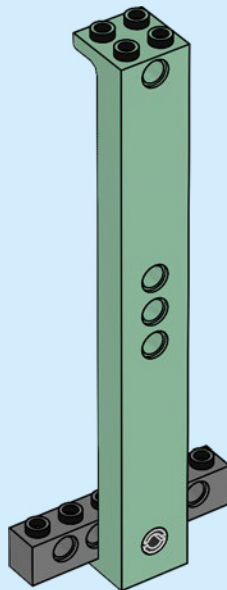

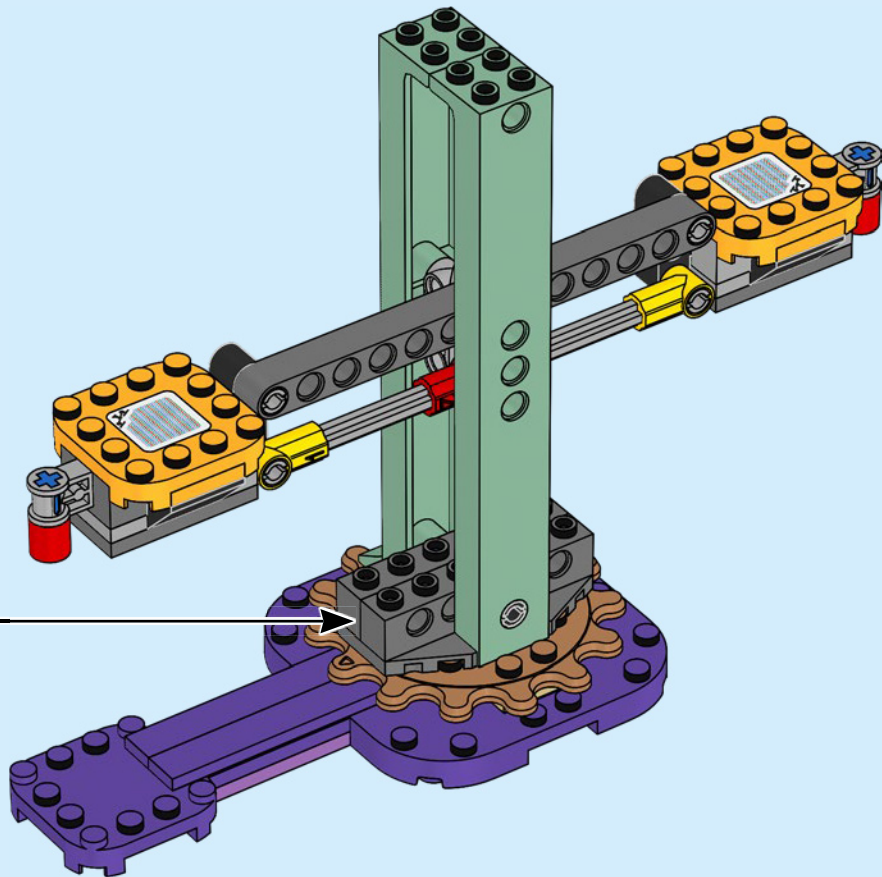

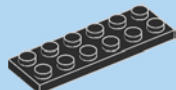

1x

32

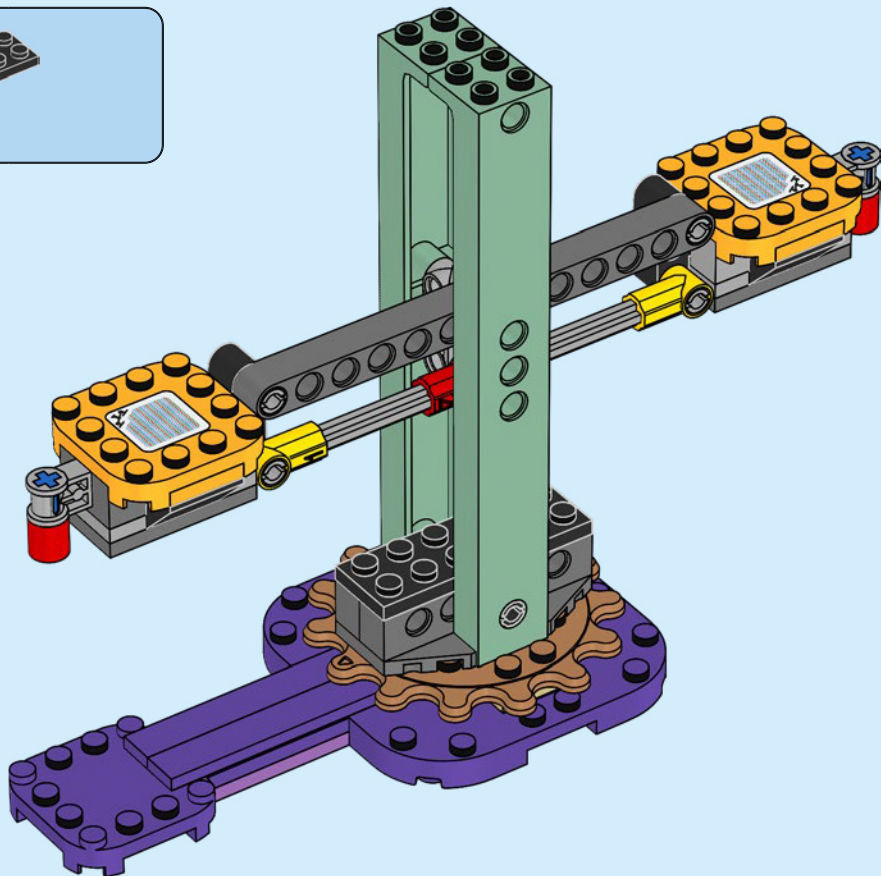



1x

33

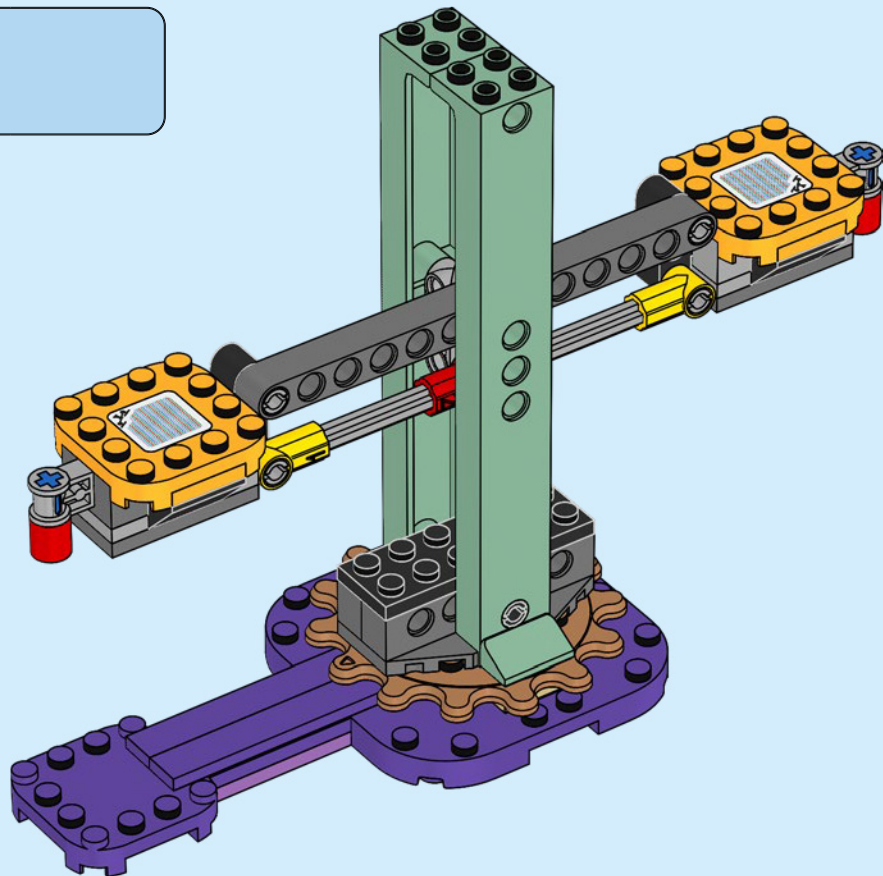



2x

34

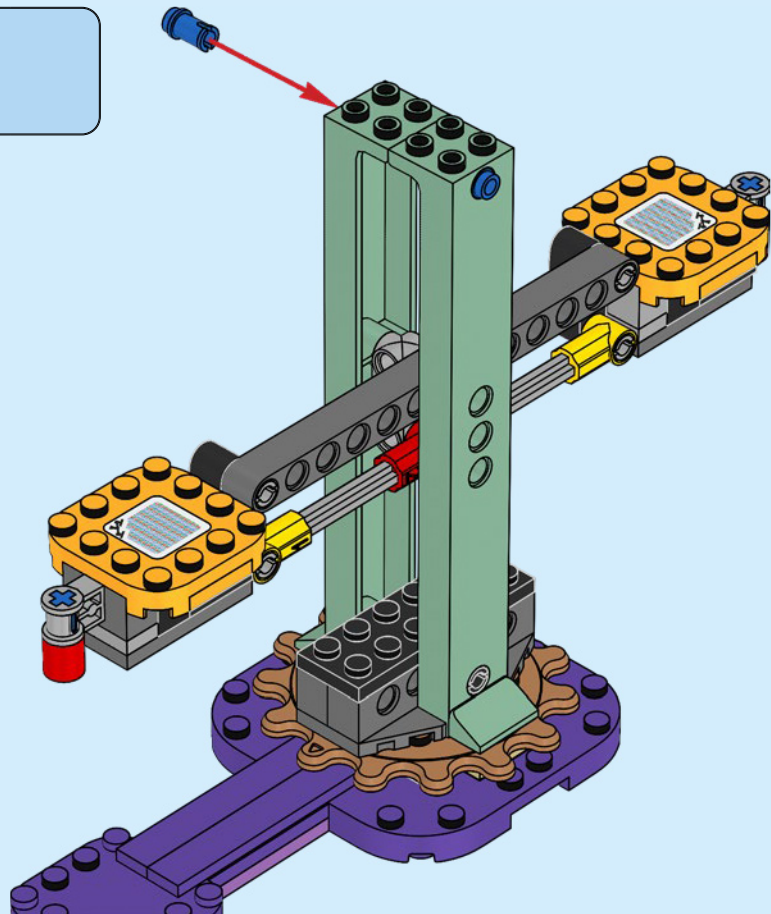

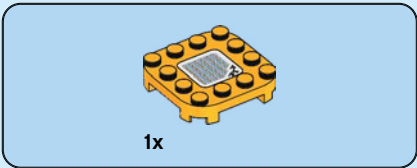

35

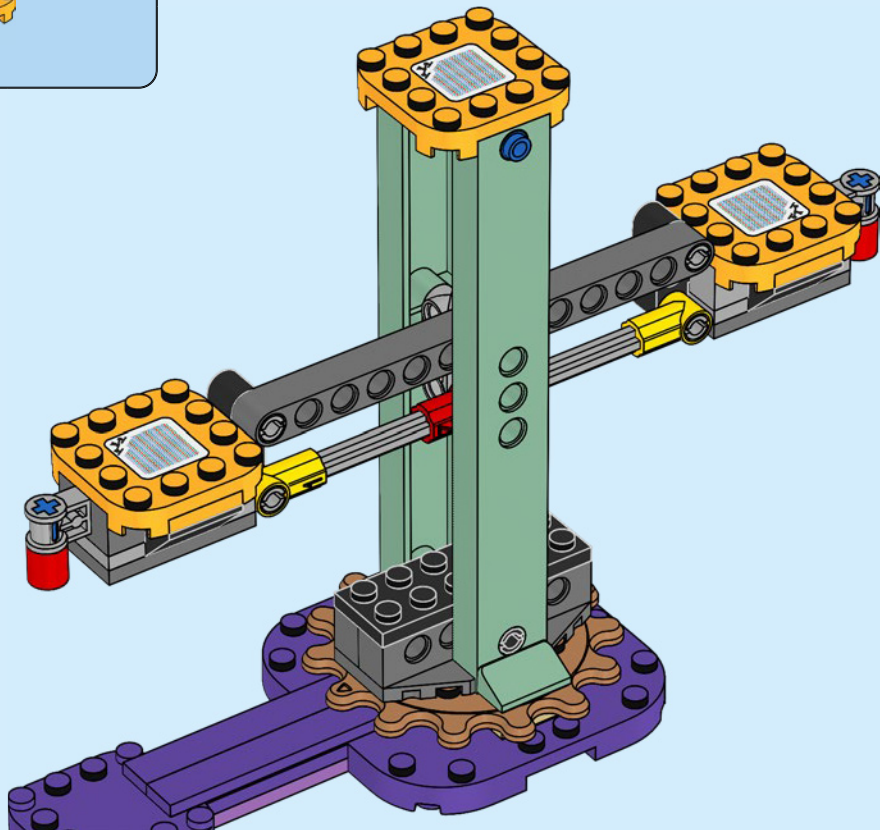



2x

36

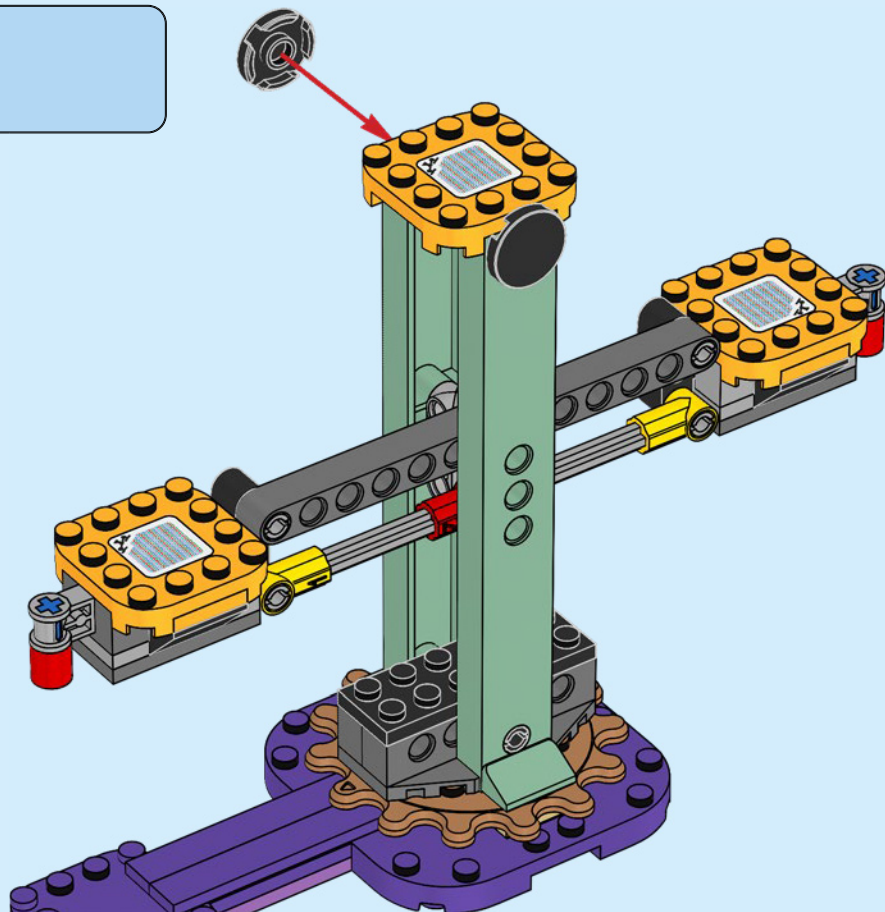

37

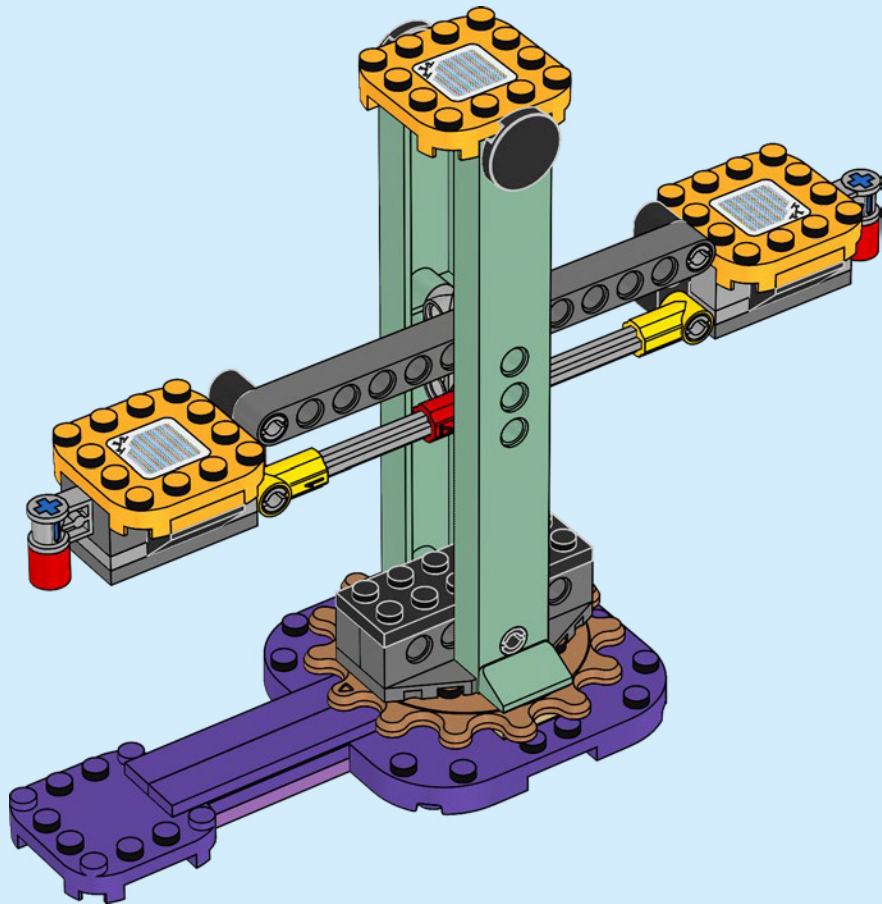

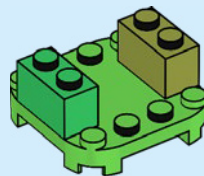
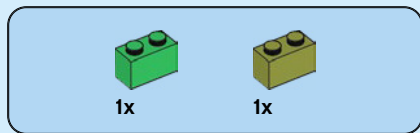
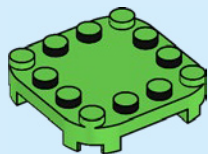
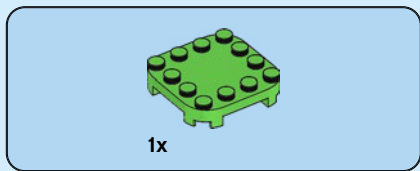
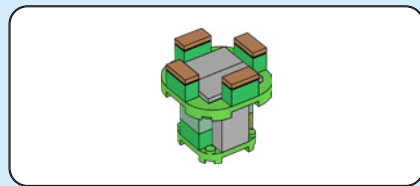
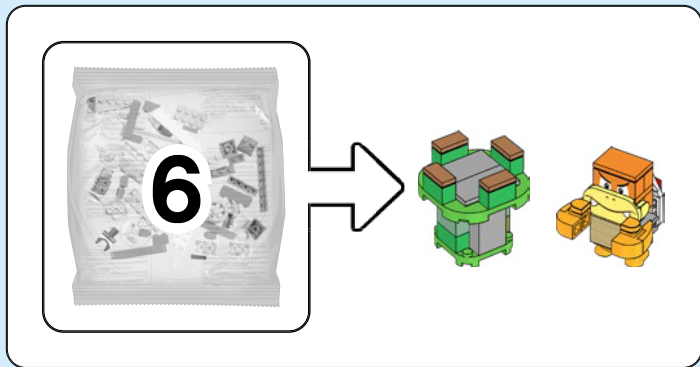

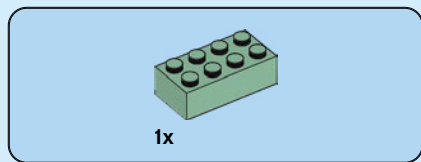

3

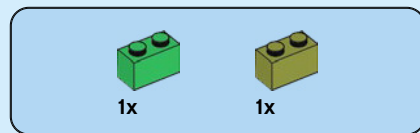
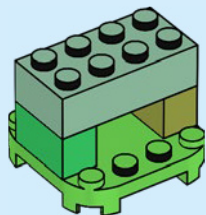

4

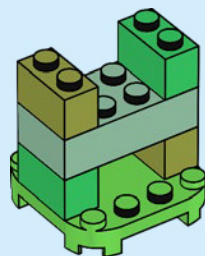

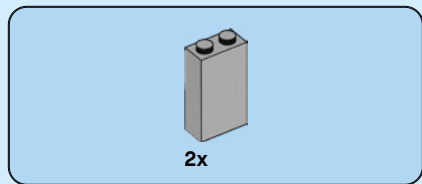

5

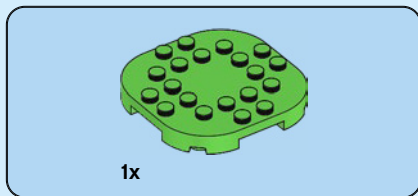
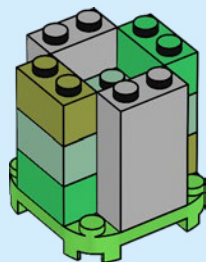

6

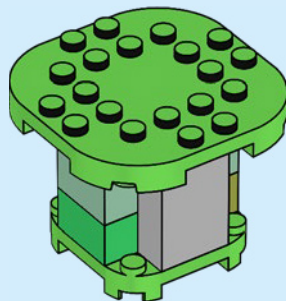

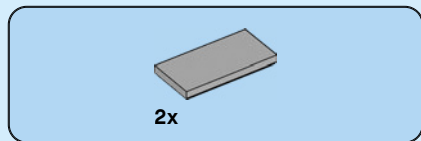

7

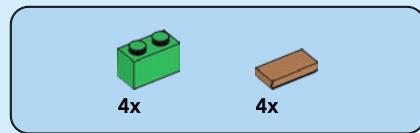
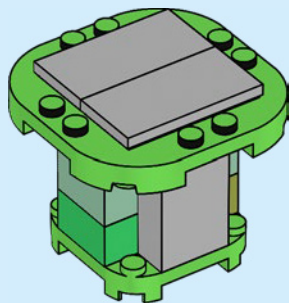

8

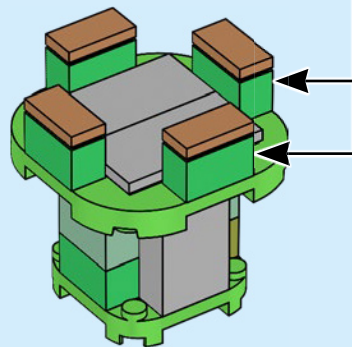
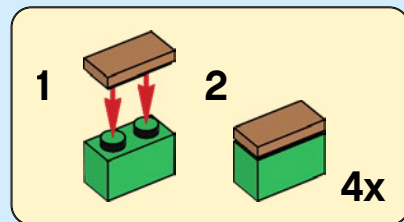

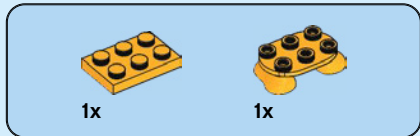
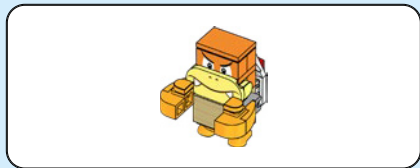

1

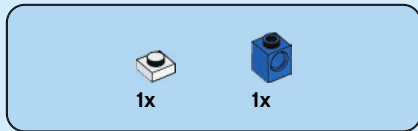
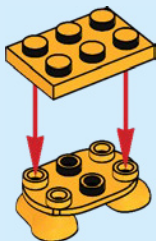

2

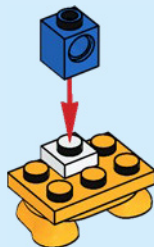

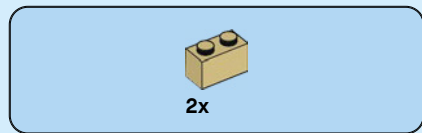

3

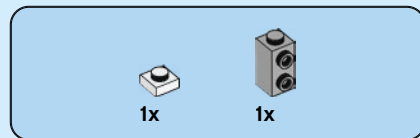
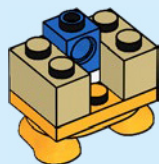

4

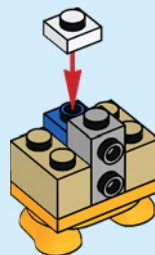



1x



2x

5

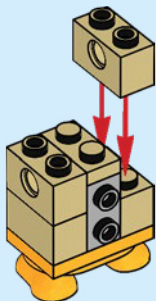

1x

6





2x

7

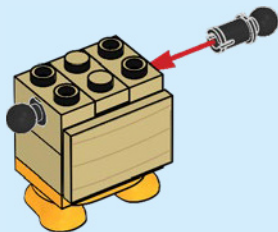

1x



2x

8





1x



2x

9



2x

10

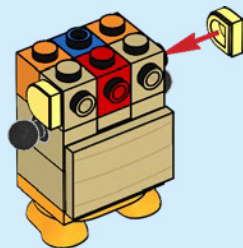



1x

11



1x



1x

12

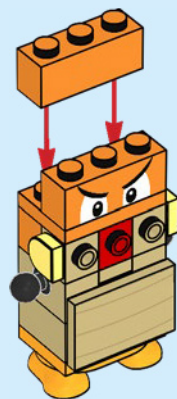

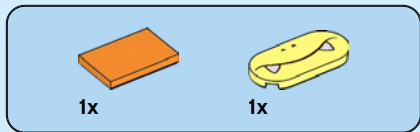

13



82



14

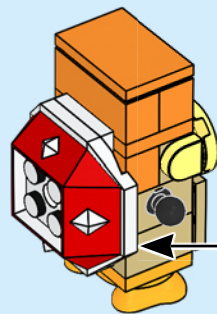
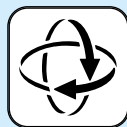
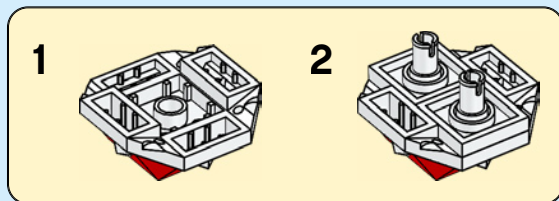



1x

15



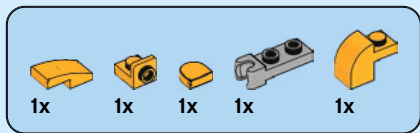

16

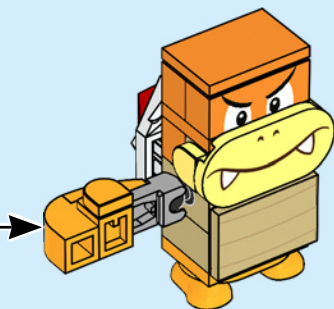
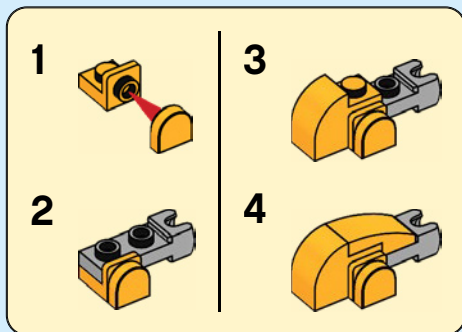
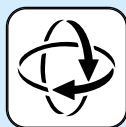

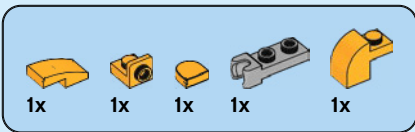

17

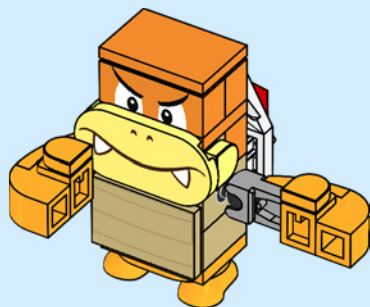
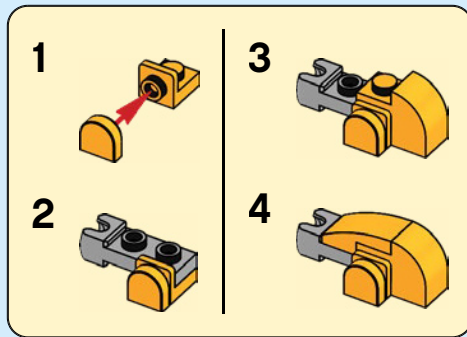





1

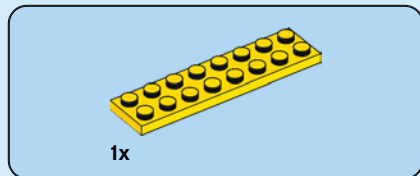
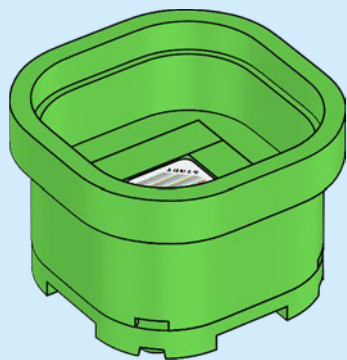

2

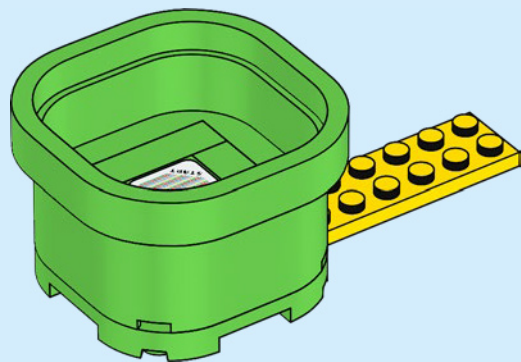



2x



2x

3

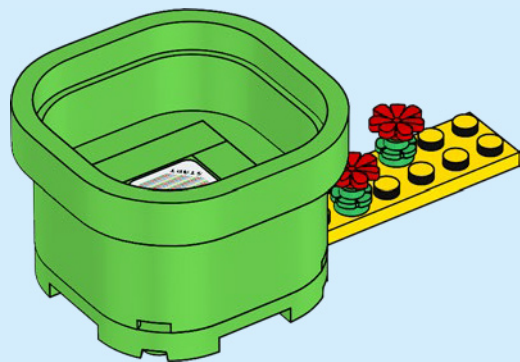
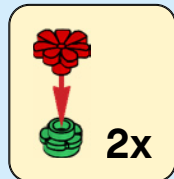

1x

4

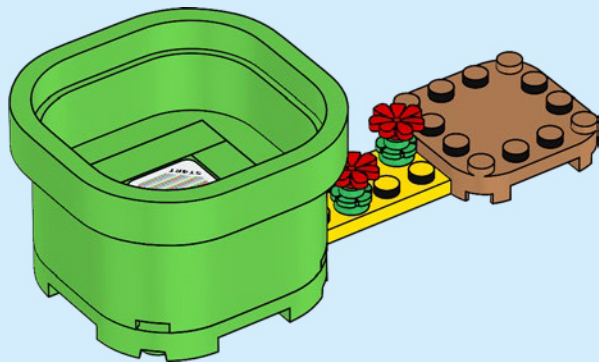

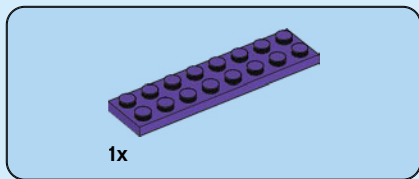

5

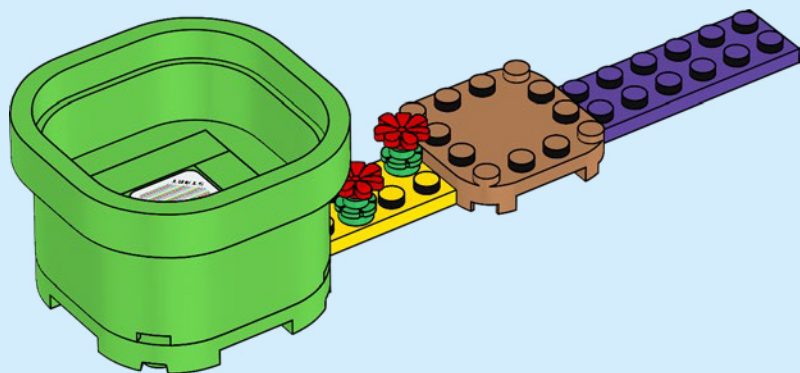

6

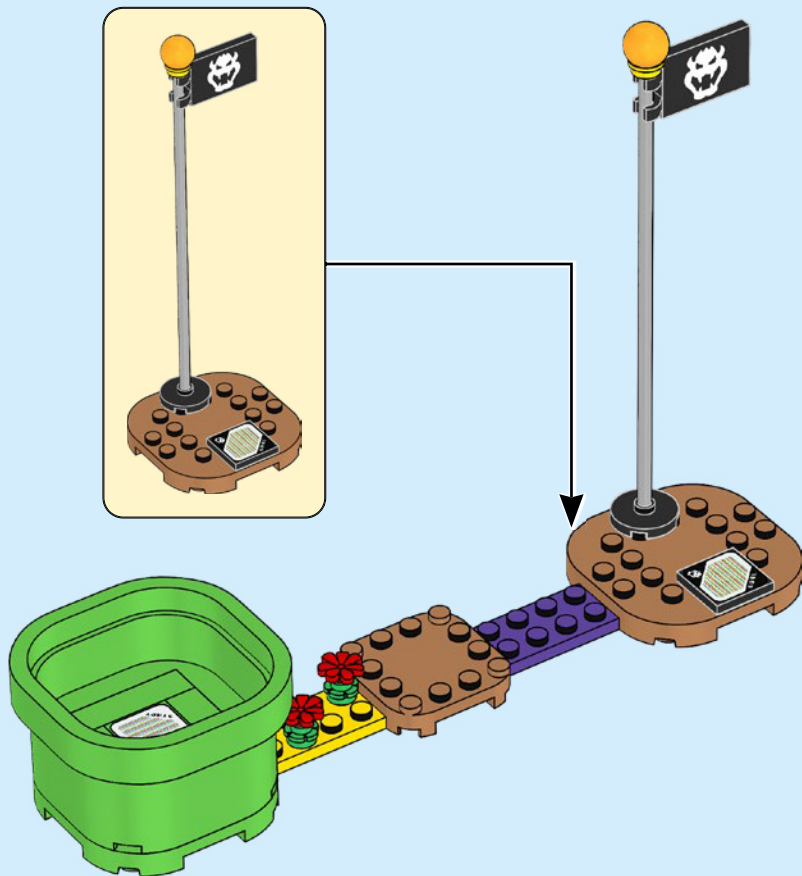

7

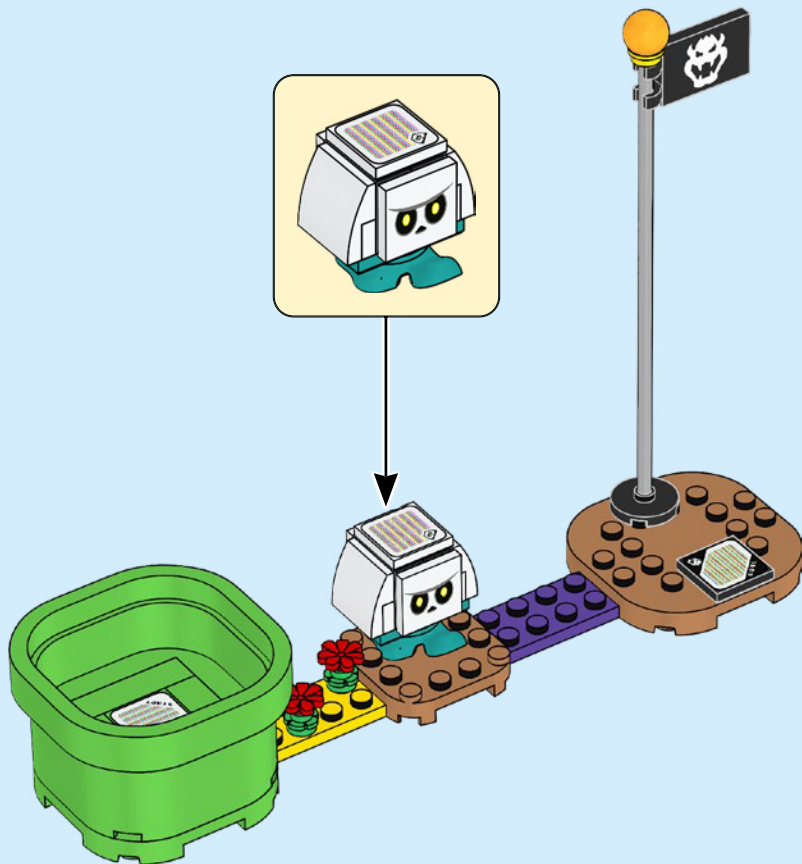



2x
302401



2x
6172366



2x
6044691



1x
6093053



1x
306901



2x
302301



2x
6312480



1x
4249563



2x
6313603



1x
6334685



1x
306801



2x
6047220



1x
6333979



1x
6302720



2x
6175968



4x
4114026



2x
4109995



2x
4205107



1x
4113917



1x
6353867



2x
4114319



2x
6182260



2x
6093950



1x
4558886



2x
6278441



1x
4278275



1x
6102138



1x
6354349



1x
6351572



2x
4143005



2x
4119014



2x
4206482



2x
6284577



1x
6168644



2x
6329889



3x
403224



2x
6353866



1x
6302719



1x
6315656



1x
302024



1x
6314197



1x
6314191



3x
303424



2x
306226



2x
6344752



2x
6279875



3x
6070695



1x
6195325



1x
6315659



2x
4552347



1x
6369098



2x
4188534



1x
6312482



3x
4517986



1x
379526



2x
6135287



1x
6038353



6x
4107736



1x
6299948



2x
303928



3x
4106356



5x
4647553



2x
6195258



1x
6354351



1x
6363295



2x
6195267



3x
6308875



2x
6301631



1x
6294708



1x
6166111





2x
4173805



1x
6353862



1x
4118787



1x
6293710



1x
4125278



1x
6357991



1x
6334098



1x
6334686



2x
6210479



2x
6353195

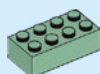

5x
6075626



2x
6357747



2x
6313554



1x
6071608



2x
6249235



4x
6028736



2x
6099728



2x
6374487



1x
6353232



1x
6097503

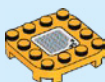

3x
6360150



1x
6351935

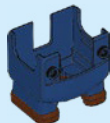

1x
6355368



4x
6170387



4x
4651063



2x
6284071



1x
6168647



1x
6225242



1x
6052200



4x
4211807



4x
6000066



4x
4211398



2x
6276874



1x
6354352



2x
6338163



2x
4211536



1x
6282158



2x
4560183



2x
4211639



4x
6178919



1x
6354332



2x
4527082



2x
4211065



2x
4210917



1x
6252371



1x
6186825



1x
4210678

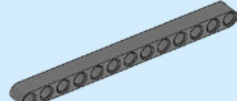

1x
4522937



1x
6206151



2x
6353190



2x
6240463



1x
6353194



2x
6264994



2x
6353192



Customer Service

Kundenservice

Service Consommateurs

Servicio Al Consumidor

LEGO.com/service or dial



00800 5346 5555 :



1-800-422-5346 :



1x
6353865



1x
4654128



1x
6353864



1x
6314374



1x
6353189



3x
6288181



2x
6359698



1x
6096589



1x
6371087



2x
6250598



1x
6353863



7x
6024722



2x
6315196



2x
6030277



2x
6334094



2x
4619657

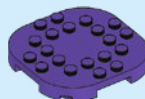

1x
6326550



2x
6109931

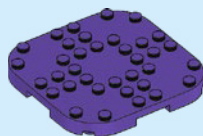

1x
6326551



4x
6021997



2x
6093494



5x
6308873



2x
6301636

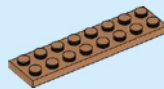

3x
6226644



2x
6338455

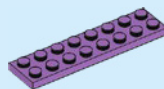

1x
6330087

