



**X11SPL-F**

**USER'S MANUAL**

Revision 1.0b

The information in this user's manual has been carefully reviewed and is believed to be accurate. The manufacturer assumes no responsibility for any inaccuracies that may be contained in this document, and makes no commitment to update or to keep current the information in this manual, or to notify any person or organization of the updates. **Please Note: For the most up-to-date version of this manual, please see our website at [www.supermicro.com](http://www.supermicro.com).**

Super Micro Computer, Inc. ("Supermicro") reserves the right to make changes to the product described in this manual at any time and without notice. This product, including software and documentation, is the property of Supermicro and/or its licensors, and is supplied only under a license. Any use or reproduction of this product is not allowed, except as expressly permitted by the terms of said license.

IN NO EVENT WILL Super Micro Computer, Inc. BE LIABLE FOR DIRECT, INDIRECT, SPECIAL, INCIDENTAL, SPECULATIVE OR CONSEQUENTIAL DAMAGES ARISING FROM THE USE OR INABILITY TO USE THIS PRODUCT OR DOCUMENTATION, EVEN IF ADVISED OF THE POSSIBILITY OF SUCH DAMAGES. IN PARTICULAR, SUPER MICRO COMPUTER, INC. SHALL NOT HAVE LIABILITY FOR ANY HARDWARE, SOFTWARE, OR DATA STORED OR USED WITH THE PRODUCT, INCLUDING THE COSTS OF REPAIRING, REPLACING, INTEGRATING, INSTALLING OR RECOVERING SUCH HARDWARE, SOFTWARE, OR DATA.

Any disputes arising between manufacturer and customer shall be governed by the laws of Santa Clara County in the State of California, USA. The State of California, County of Santa Clara shall be the exclusive venue for the resolution of any such disputes. Supermicro's total liability for all claims will not exceed the price paid for the hardware product.

FCC Statement: This equipment has been tested and found to comply with the limits for a Class A digital device pursuant to Part 15 of the FCC Rules. These limits are designed to provide reasonable protection against harmful interference when the equipment is operated in a commercial environment. This equipment generates, uses, and can radiate radio frequency energy and, if not installed and used in accordance with the manufacturer's instruction manual, may cause harmful interference with radio communications. Operation of this equipment in a residential area is likely to cause harmful interference, in which case you will be required to correct the interference at your own expense.

California Best Management Practices Regulations for Perchlorate Materials: This Perchlorate warning applies only to products containing CR (Manganese Dioxide) Lithium coin cells. "Perchlorate Material-special handling may apply. See [www.dtsc.ca.gov/hazardouswaste/perchlorate](http://www.dtsc.ca.gov/hazardouswaste/perchlorate)".

**WARNING**: Handling of lead solder materials used in this product may expose you to lead, a chemical known to the State of California to cause birth defects and other reproductive harm.

The products sold by Supermicro are not intended for and will not be used in life support systems, medical equipment, nuclear facilities or systems, aircraft, aircraft devices, aircraft/emergency communication devices or other critical systems whose failure to perform be reasonably expected to result in significant injury or loss of life or catastrophic property damage. Accordingly, Supermicro disclaims any and all liability, and should buyer use or sell such products for use in such ultra-hazardous applications, it does so entirely at its own risk. Furthermore, buyer agrees to fully indemnify, defend and hold Supermicro harmless for and against any and all claims, demands, actions, litigation, and proceedings of any kind arising out of or related to such ultra-hazardous use or sale.

Manual Revision 1.0b

Release Date: April 04, 2018

Unless you request and receive written permission from Super Micro Computer, Inc., you may not copy any part of this document. Information in this document is subject to change without notice. Other products and companies referred to herein are trademarks or registered trademarks of their respective companies or mark holders.

Copyright © 2018 by Super Micro Computer, Inc.  
All rights reserved.

**Printed in the United States of America**

# Preface

## About This Manual

This manual is written for system integrators, IT technicians and knowledgeable end users. It provides information for the installation and use of the X11SPL-F motherboard.

## About This Motherboard

The Supermicro X11SPL-F motherboard supports an Intel® Xeon 81xx/61xx/51xx/41xx/31xx series (Socket P0-LGA 3647) processor with up to 28 cores and a thermal design power (TDP) of up to 165W. Built with the Intel PCH C621 chipset, the motherboard supports 6-channel, 8-DIMM DDR4 ECC RDIMM/LRDIMM memory with speeds of up to 2666MHz. It features such technologies as the Intel Virtualization Technology for Directed I/O for improved security and system reliability. The X11SPL-F includes PCI-Express 3.0 slots, SATA 3.0 ports, dual 1G Base-T LAN support, and an M.2 slot (Type 2280 and 22110). This motherboard is ideal for I/O intensive application and video surveillance. Please note that this motherboard is intended to be installed and serviced by professional technicians only. For processor/memory updates, please refer to our website at <http://www.supermicro.com/products/>.

## Conventions Used in the Manual

Special attention should be given to the following symbols for proper installation and to prevent damage done to the components or injury to yourself:



**Warning!** Indicates important information given to prevent equipment/property damage or personal injury.



**Warning!** Indicates high voltage may be encountered while performing a procedure.



**Important:** Important information given to ensure proper system installation or to relay safety precautions.



**Note:** Additional Information given to differentiate various models or provides information for proper system setup.

## Contacting Supermicro

### Headquarters

Address: Super Micro Computer, Inc.  
980 Rock Ave.  
San Jose, CA 95131 U.S.A.

Tel: +1 (408) 503-8000

Fax: +1 (408) 503-8008

Email: [marketing@supermicro.com](mailto:marketing@supermicro.com) (General Information)  
[support@supermicro.com](mailto:support@supermicro.com) (Technical Support)

Website: [www.supermicro.com](http://www.supermicro.com)

### Europe

Address: Super Micro Computer B.V.  
Het Sterrenbeeld 28, 5215 ML  
's-Hertogenbosch, The Netherlands

Tel: +31 (0) 73-6400390

Fax: +31 (0) 73-6416525

Email: [sales@supermicro.nl](mailto:sales@supermicro.nl) (General Information)  
[support@supermicro.nl](mailto:support@supermicro.nl) (Technical Support)  
[rma@supermicro.nl](mailto:rma@supermicro.nl) (Customer Support)

Website: [www.supermicro.nl](http://www.supermicro.nl)

### Asia-Pacific

Address: Super Micro Computer, Inc.  
3F, No. 150, Jian 1st Rd.  
Zhonghe Dist., New Taipei City 235  
Taiwan (R.O.C)

Tel: +886-(2) 8226-3990

Fax: +886-(2) 8226-3992

Email: [support@supermicro.com.tw](mailto:support@supermicro.com.tw)

Website: [www.supermicro.com.tw](http://www.supermicro.com.tw)

# Table of Contents

## **Chapter 1 Introduction**

1.1 Checklist.....	8
Quick Reference .....	11
Quick Reference Table.....	12
Motherboard Features.....	14
1.2 Processor and Chipset Overview.....	18
1.3 Special Features .....	18
Recovery from AC Power Loss.....	18
1.4 System Health Monitoring.....	19
Onboard Voltage Monitors .....	19
Fan Status Monitor with Firmware Control .....	19
Environmental Temperature Control .....	19
System Resource Alert.....	19
1.5 ACPI Features.....	19
1.6 Power Supply .....	20
1.7 Serial Port.....	20

## **Chapter 2 Installation**

2.1 Static-Sensitive Devices.....	21
Precautions .....	21
Unpacking .....	21
2.2 Processor and Heatsink Installation.....	22
The Intel Xeon 81xx/61xx/51xx/41xx/31xx Series Processor.....	22
Overview of the Processor Carrier Assembly.....	23
Overview of the CPU Socket.....	23
Overview of the Processor Heatsink Module.....	24
Creating the Non-F Model Processor Carrier Assembly.....	25
Assembling the Processor Heatsink Module .....	26
Preparing the CPU Socket for Installation.....	27
Installing the Processor Heatsink Module.....	28
Removing the Processor Heatsink Module.....	29
2.3 Motherboard Installation.....	30

Tools Needed .....	30
Location of Mounting Holes .....	30
Installing the Motherboard.....	31
2.4 Memory Support and Installation .....	32
Memory Support.....	32
General Guidelines for Optimizing Memory Performance .....	33
DIMM Installation .....	34
DIMM Removal .....	34
2.5 Rear I/O Ports .....	35
2.6 Front Control Panel.....	40
2.7 Connectors .....	45
Power Connections .....	45
Headers.....	47
2.8 Jumper Settings .....	56
How Jumpers Work.....	56
2.9 LED Indicators.....	59
<b>Chapter 3 Troubleshooting</b>	
3.1 Troubleshooting Procedures .....	62
Before Power On .....	62
No Power .....	62
No Video .....	63
System Boot Failure .....	63
Memory Errors .....	63
Losing the System's Setup Configuration.....	64
When the System Becomes Unstable .....	64
3.2 Technical Support Procedures .....	66
3.3 Frequently Asked Questions .....	67
3.4 Battery Removal and Installation .....	68
Battery Removal.....	68
Proper Battery Disposal.....	68
Battery Installation.....	68
3.5 Returning Merchandise for Service.....	69

---

---

**Chapter 4 BIOS**

4.1 Introduction .....	70
4.2 Main Setup .....	71
4.3 Advanced Setup Configurations .....	73
4.4 Event Logs .....	100
4.5 IPMI .....	102
4.6 Security .....	105
4.7 Boot .....	109
4.8 Save & Exit .....	112

**Appendix A BIOS Codes****Appendix B Software Installation**

B.1 Installing Software Programs .....	116
B.2 SuperDoctor® 5 .....	117

**Appendix C Standardized Warning Statements**

Battery Handling .....	118
Product Disposal .....	120

**Appendix D UEFI BIOS Recovery**

# Chapter 1

## Introduction

Congratulations on purchasing your computer motherboard from an industry leader. Supermicro motherboards are designed to provide you with the highest standards in quality and performance.

In addition to the motherboard, several important parts that are included in the retail box are listed below. If anything listed is damaged or missing, please contact your retailer.

### 1.1 Checklist

Main Parts List		
Description	Part Number	Quantity
Supermicro Motherboard	X11SPL-F	1
I/O Shield	MCP-260-00109-0N	1
SATA Cables	CBL-0044L	6
Quick Reference Guide	MNL-1950-QRG	1

### Important Links

For your system to work properly, please follow the links below to download all necessary drivers/utilities and the user's manual for your server.

- Supermicro product manuals: <http://www.supermicro.com/support/manuals/>
- Product drivers and utilities: <ftp://ftp.supermicro.com>
- Product safety info: [http://www.supermicro.com/about/policies/safety\\_information.cfm](http://www.supermicro.com/about/policies/safety_information.cfm)
- If you have any questions, please contact our support team at: [support@supermicro.com](mailto:support@supermicro.com)

This manual may be periodically updated without notice. Please check the Supermicro website for possible updates to the manual revision level.

Figure 1-1. X11SPL-F Motherboard Image

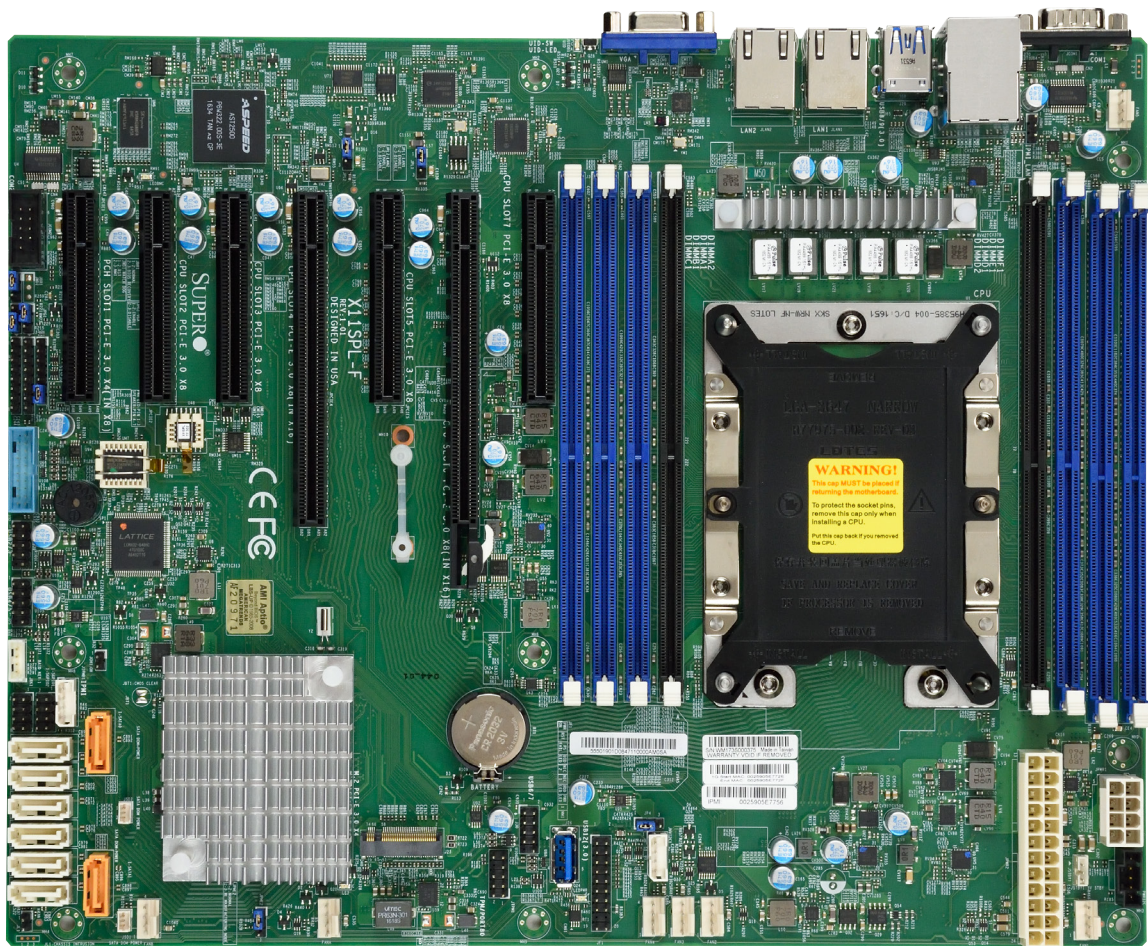

**Note:** All graphics shown in this manual were based upon the latest PCB revision available at the time of publication of the manual. The motherboard you received may or may not look exactly the same as the graphics shown in this manual.

**Figure 1-2. X11SPL-F Motherboard Layout**  
(not drawn to scale)

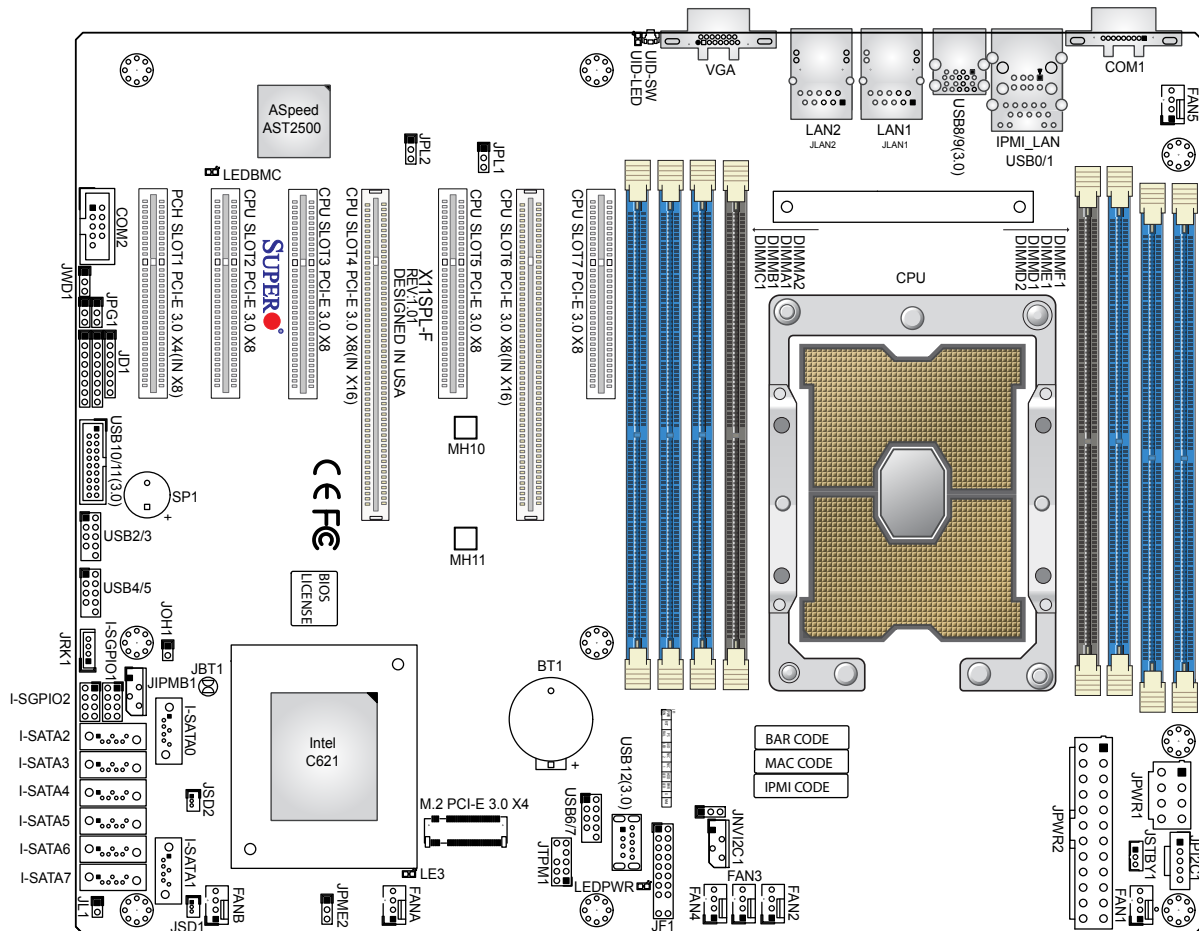

 **Note:** Components not documented are for internal testing only.

## Quick Reference

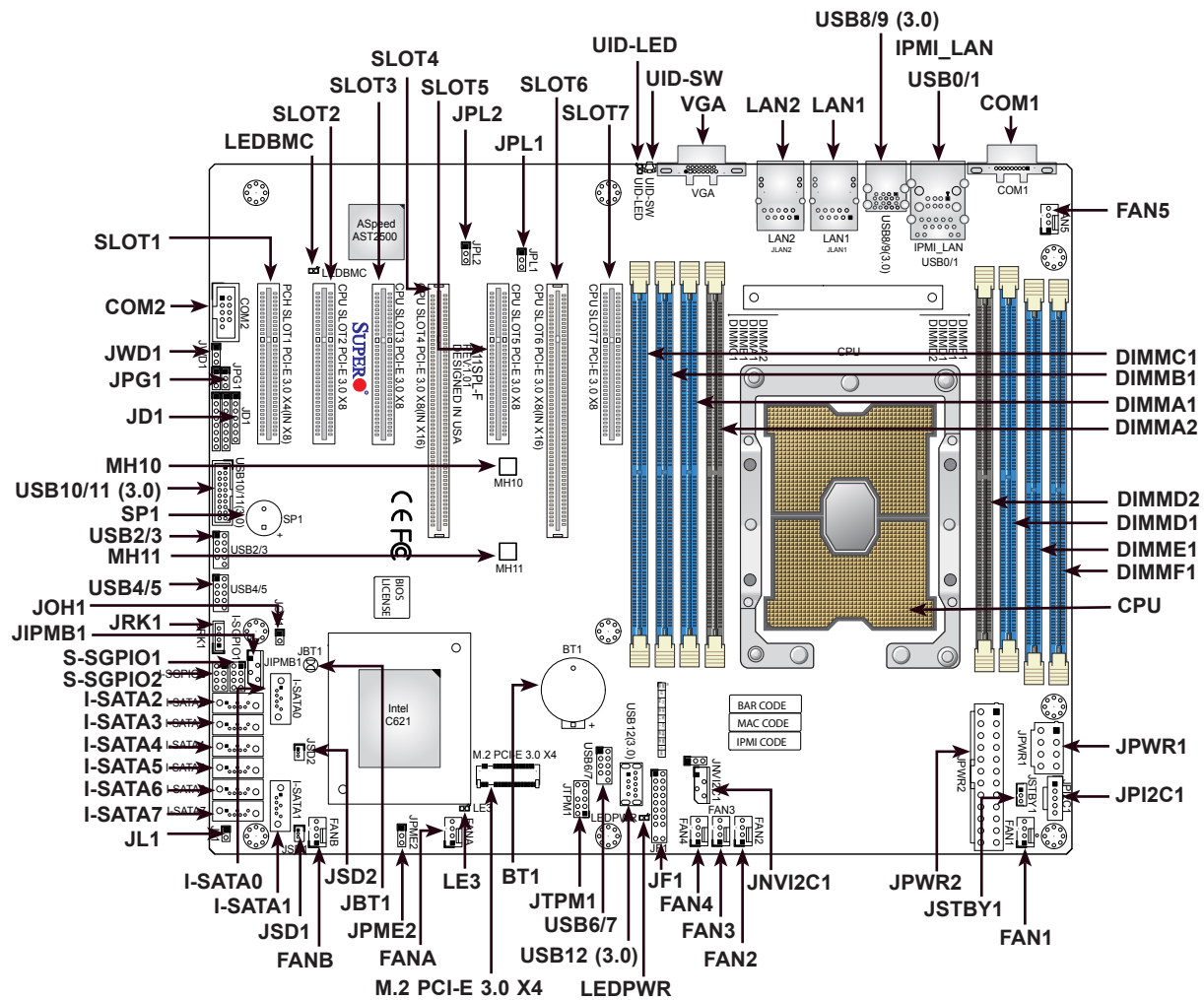

## Notes:

- See Chapter 2 for detailed information on jumpers, I/O ports, and JF1 front panel connections.
- "■" indicates the location of Pin 1.
- Jumpers/LED indicators not indicated are used for testing only.
- Use only the correct type of onboard CMOS battery as specified by the manufacturer. Do not install the onboard battery upside down to avoid possible explosion.

## Quick Reference Table

Jumper	Description	Default Setting
JBT1	CMOS Clear	Open (Normal)
JPG1	VGA Enable/Disable	Pins 1-2 (Enabled)
JPL1	LAN1 Enable/Disable	Pins 1-2 (Enabled)
JPL2	LAN2 Enable/Disable	Pins 1-2 (Enabled)
JPME2	ME Manufacturing Mode	Pins 1-2 (Normal)
JWD1	Watchdog Timer	Pins 1-2 (Reset)

LED	Description	Status
LE3	M.2 LED	Blinking Green: Device Working
LEDBMC	BMC Heartbeat LED	Blinking Green: BMC Normal
LEDPWR	Onboard Power LED	Solid Green: Power On
UID-LED	Unit Identifier (UID) LED	Solid Blue: Unit Identified

Connector	Description
BT1	Onboard Battery
COM1, COM2	COM Port, COM Header
FAN1 ~ FAN5, FANA/FANB	CPU/System Fan Headers
IPMI_LAN	Dedicated IPMI LAN Port
I-SATA0 ~ I-SATA7	Intel® PCH SATA 3.0 Ports (with RAID 0, 1, 5, 10)
I-SGPIO1, I-SGPIO2	Serial Link General Purpose I/O Connection Headers
JD1	Speaker/Power LED Indicator (Pins 1-3: Power LED, Pins 4-7: Speaker)
JF1	Front Control Panel Header
JIPMB1	4-pin BMC External I <sup>2</sup> C Header (for an IPMI Card)
JL1	Chassis Intrusion Header
JNVI <sup>2</sup> C1	NVMe I <sup>2</sup> C Header
JOH1	Overheat LED Indicator
JPI <sup>2</sup> C1	Power System Management Bus (SMB) I <sup>2</sup> C Header
JPWR1	8-pin 12V CPU Power Connector
JPWR2	24-pin ATX Power Connector
JRK1	Intel RAID Key Header
JSD1, JSD2	SATA DOM Power Connectors
JSTBY1	Standby Power Header
JTPM1	Trusted Platform Module/Port 80 Connector
LAN1, LAN2	Dual 1G Base-T Ports
M.2	M.2 PCI-E 3.0 x4 or SATA 3.0 Slot (Supports M-Key 2280 and 22110)
MH10, MH11	M.2 Mounting Holes
SLOT1	PCH PCI-E 3.0 x4 (in x8) Slot





**Note:** Table is continued on the next page.

---

---

<b>Connector</b>	<b>Description</b>
SLOT2, SLOT3, SLOT5, SLOT7	CPU PCI-E 3.0 x8 Slot
SLOT4, SLOT6	CPU PCI-E 3.0 x8 (in x16) Slot
SP1	Internal Speaker/Buzzer
UID-SW	Unit Identifier (UID) Switch
USB0/1	Back Panel Universal Serial Bus (USB) 2.0 Ports
USB2/3, USB4/5, USB6/7	Front Accessible USB 2.0 Headers
USB8/9	Back Panel USB 3.0 Ports
USB10/11	Front Accessible USB 3.0 Header
USB12	USB 3.0 Type-A Header
VGA	VGA Port

## Motherboard Features

<b>Motherboard Features</b>	
<b>CPU</b>	
<ul style="list-style-type: none"> <li>Supports an Intel® Xeon 81xx/61xx/51xx/41xx/31xx series (Socket P0-LGA 3647) processor with up to 28 cores and a thermal design power (TDP) of up to 165W</li> </ul>	
 <b>Note:</b> The X11SPL-F motherboard does not support FPGA or Fabric processors.	
<b>Memory</b>	
<ul style="list-style-type: none"> <li>Up to 256GB of RDIMM, 512GB of LRDIMM, and 1TB of 3DS LRDIMM DDR4 (288-pin) ECC memory with speeds of up to 2666MHz in eight memory slots</li> </ul>	
 <b>Note:</b> Memory speed support depends on the processors used in the system.	
<b>DIMM Size</b>	
<ul style="list-style-type: none"> <li>Up to 128GB at 1.2V</li> </ul>	
 <b>Note:</b> For the latest CPU/memory updates, please refer to our website at <a href="http://www.supermicro.com/products/motherboard">http://www.supermicro.com/products/motherboard</a> .	
<b>Chipset</b>	
<ul style="list-style-type: none"> <li>Intel PCH C621</li> </ul>	
<b>Expansion Slots</b>	
<ul style="list-style-type: none"> <li>One (1) PCI-Express 3.0 x4 (in x8) Slot (PCH SLOT1)</li> <li>Four (4) PCI-Express 3.0 x8 Slots (CPU SLOT2, SLOT3, SLOT5, SLOT7)</li> <li>Two (2) PCI-Express 3.0 x8 (in x16) Slot (CPU SLOT4, SLOT6)</li> </ul>	
<b>Network</b>	
<ul style="list-style-type: none"> <li>Intel Ethernet Controller i210 + i210 for Dual 1G BASE-T Ports</li> <li>One (1) Dedicated IPMI LAN located on the rear I/O panel</li> </ul>	
<b>Baseboard Management Controller (BMC)</b>	
<ul style="list-style-type: none"> <li>ASpeed AST2500 BMC</li> </ul>	
<b>Graphics</b>	
<ul style="list-style-type: none"> <li>Graphics controller via ASpeed AST2500 BMC</li> </ul>	
<b>I/O Devices</b>	
<ul style="list-style-type: none"> <li>Serial (COM) Port</li> </ul>	<ul style="list-style-type: none"> <li>One (1) serial port on the rear I/O panel (COM1)</li> <li>One (1) front accessible serial port header (COM2)</li> </ul>
<ul style="list-style-type: none"> <li>SATA 3.0</li> </ul>	<ul style="list-style-type: none"> <li>Eight (8) SATA 3.0 ports at 6Gb/s (I-SATA0 ~ I-SATA7 with RAID 0, 1, 5, 10)</li> </ul>
<ul style="list-style-type: none"> <li>Video (VGA) Port</li> </ul>	<ul style="list-style-type: none"> <li>One (1) VGA connection on the rear I/O panel</li> </ul>

 **Note:** The table above is continued on the next page.

## Motherboard Features

### Peripheral Devices

- Two (2) USB 2.0 ports on the rear I/O panel (USB0/1)
- Two (2) USB 3.0 ports on the rear I/O panel (USB8/9)
- Three (3) front accessible USB 2.0 headers with two (2) USB connections (USB2/3, USB4/5, USB6/7)
- One (1) front accessible USB 3.0 header with two (2) USB connections (USB10/11)
- One (1) USB 3.0 Type-A header (USB12)

### BIOS

- 256Mb AMI BIOS® SPI Flash ROM
- ACPI 6.0, Plug and Play (PnP), BIOS rescue hot-key, SPI dual/quad speed support, riser card auto detection support, real time clock (RTC) wakeup, and SMBIOS 3.0 or later

### Power Management

- ACPI power management
- Power button override mechanism
- Power-on mode for AC power recovery
- Wake-On LAN
- Power supply monitoring

### System Health Monitoring

- Onboard voltage monitoring for +1.8V, +3.3V, +5V, +/-12V, +3.3V stdbv, +5V stdbv, VBAT, HT, memory, PCH temperature, system temperature, and memory temperature
- 5 CPU switch phase voltage regulator
- CPU thermal trip support
- Platform Environment Configuration Interface (PECI)/TSI

### Fan Control

- Fan status monitoring via IPMI connections
- Single cooling zone
- Low-noise fan speed control
- Seven (7) 4-pin fan headers

### System Management

- Trusted Platform Module (TPM) support
- SuperDoctor® 5
- Redundant power supply unit detection sensor
- Chassis intrusion header and detection
- Server Platform Service

### LED Indicators

- CPU/system overheat LED
- Power/suspend-state indicator LED
- Fan failed LED
- UID/remote UID
- HDD activity LED
- LAN activity LED



**Note:** The table above is continued on the next page.

## Motherboard Features

### Dimensions

- 12" (W) x 9.6" (L) ATX (304.8mm x 243.84mm)





**Note 1:** The CPU maximum thermal design power (TDP) is subject to chassis and heatsink cooling restrictions. For proper thermal management, please check the chassis and heatsink specifications for proper CPU TDP sizing.

**Note 2:** For IPMI configuration instructions, please refer to the Embedded IPMI Configuration User's Guide available at <http://www.supermicro.com/support/manuals/>.

**Note 3:** It is strongly recommended that you change BMC log-in information upon initial system power-on. The manufacture default username is ADMIN and the password is ADMIN. For proper BMC configuration, please refer to [http://www.supermicro.com/products/info/files/IPMI/Best\\_Practices\\_BMC\\_Security.pdf](http://www.supermicro.com/products/info/files/IPMI/Best_Practices_BMC_Security.pdf).

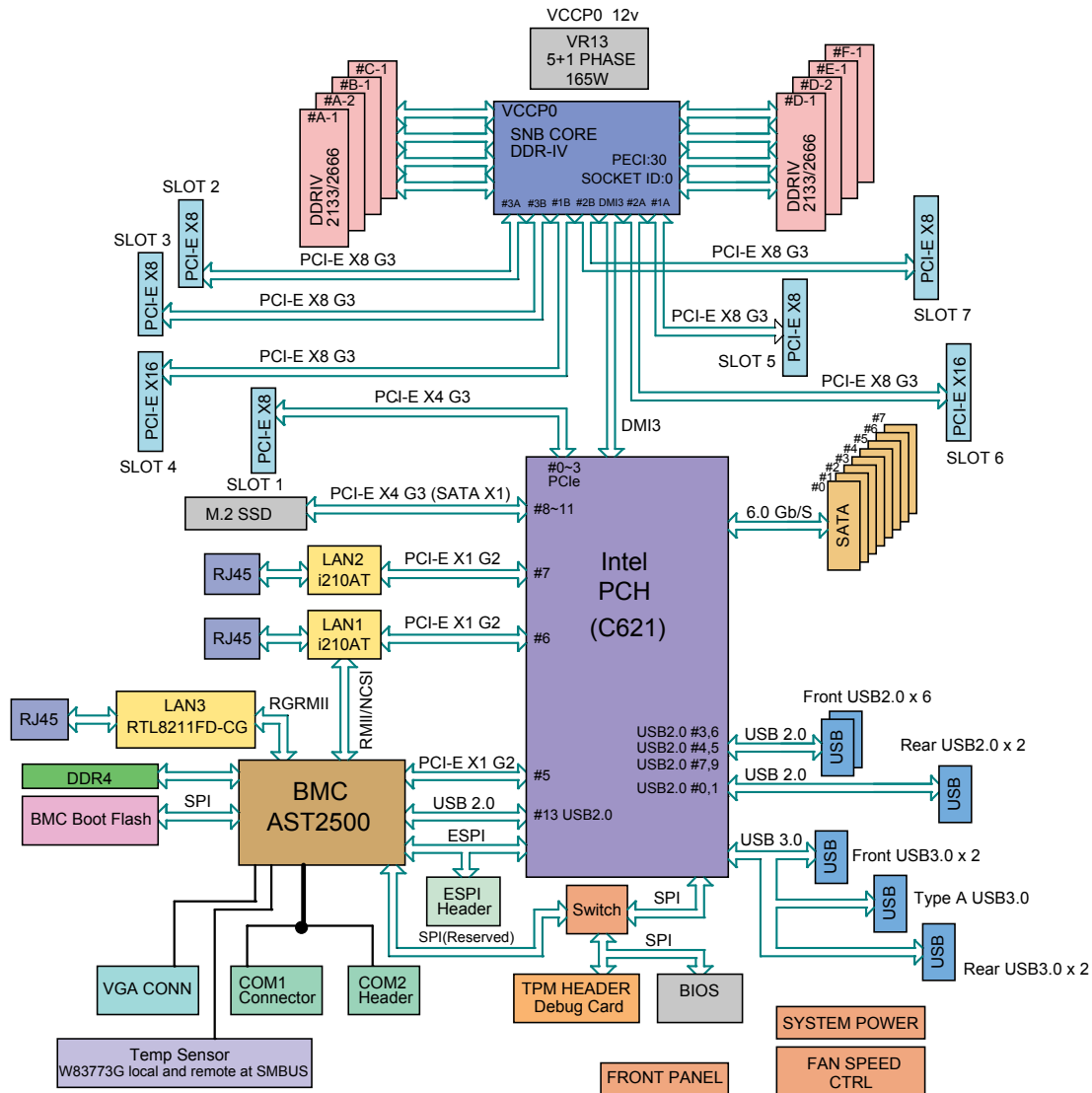
**Figure 1-3.**  
**System Block Diagram**



 **Note:** This is a general block diagram and may not exactly represent the features on your motherboard. See the previous pages for the actual specifications of your motherboard.

## 1.2 Processor and Chipset Overview

Built upon the functionality and capability of the Intel® Xeon 81xx/61xx/51xx/41xx/31xx series (Socket P0-LGA 3647) processor and the Intel PCH C621 chipset, the X11SPL-F motherboard provides system performance, power efficiency, and feature sets to address the needs of next-generation computer users. This motherboard is the perfect solution for I/O intensive application and video surveillance.

The Intel PCH C621 chipset supports the following features:

- DDR4 288-pin memory support
- Intel Rapid Storage Technology Enterprise
- ACPI Power Management
- Digital Media Interface (DMI)
- Management Engine (ME)
- SMBus speeds of up to 400KHz for BMC connectivity
- Improved I/O capabilities to high-storage-capacity configurations
- SPI Enhancements
- Intel® Node Manager 3.0 for advanced power monitoring, capping, and management for BMC enhancement (see note below).
- BMC supports remote management, virtualization, and the security package for enterprise platforms



**Note:** Node Manager support depends on the power supply used in your system.

## 1.3 Special Features

### Recovery from AC Power Loss

The Basic I/O System (BIOS) provides a setting that determines how the system will respond when AC power is lost and then restored to the system. You can choose for the system to remain powered off (in which case you must press the power switch to turn it back on), or for it to automatically return to the power-on state. See the Advanced BIOS Setup section for this setting. The default setting is **Last State**.

## 1.4 System Health Monitoring

### Onboard Voltage Monitors

An onboard voltage monitor will scan the voltages of the onboard chipset, memory, CPU, and battery continuously. Once a voltage becomes unstable, a warning is given, or an error message is sent to the screen. The user can adjust the voltage thresholds to define the sensitivity of the voltage monitor.

### Fan Status Monitor with Firmware Control

The system health monitor embedded in the BMC chip can check the RPM status of the cooling fans. The CPU and chassis fans are controlled via IPMI.

### Environmental Temperature Control

System Health sensors monitor temperatures and voltage settings of onboard processors and the system in real time via the IPMI interface. Whenever the temperature of the CPU or the system exceeds a user-defined threshold, system/CPU cooling fans will be turned on to prevent the CPU or the system from overheating.



**Note:** To avoid possible system overheating, please be sure to provide adequate air-flow to your system.

### System Resource Alert

This feature is available when used with SuperDoctor 5<sup>®</sup> in the Windows OS or in the Linux environment. SuperDoctor is used to notify the user of certain system events. For example, you can configure SuperDoctor to provide you with warnings when the system temperature, CPU temperatures, voltages and fan speeds go beyond a predefined range.

## 1.5 ACPI Features

ACPI stands for Advanced Configuration and Power Interface. The ACPI specification defines a flexible and abstract hardware interface that provides a standard way to integrate power management features throughout a computer system, including its hardware, operating system and application software. This enables the system to automatically turn on and off peripherals such as CD-ROMs, network cards, hard disk drives and printers.

In addition to enabling operating system-directed power management, ACPI also provides a generic system event mechanism for Plug and Play, and an operating system-independent interface for configuration control. ACPI leverages the Plug and Play BIOS data structures, while providing a processor architecture-independent implementation that is compatible with Windows 2012/2012R and 2016 operating systems.

## 1.6 Power Supply

As with all computer products, a stable power source is necessary for proper and reliable operation. It is even more important for processors that have high CPU clock rates where noisy power transmission is present.

The X11SPL-F motherboard accommodates a 24-pin ATX power supply. Although most power supplies generally meet the specifications required by the CPU, some are inadequate. In addition, one 12V 8-pin power connection is also required to ensure adequate power supply to the system.

**Warning:** To avoid damaging the power supply or the motherboard, be sure to use a power supply that contains a 24-pin and an 8-pin power connector. Be sure to connect the power supplies to the 24-pin power connector (JPWR2), and the 8-pin power connector (JPWR1) on the motherboard. Failure in doing so may void the manufacturer warranty on your power supply and motherboard.

It is strongly recommended that you use a high quality power supply that meets ATX power supply Specification 2.02 or above. It must also be SSI compliant. (For more information, please refer to the website at <http://www.ssiforum.org/>).

## 1.7 Serial Port

The X11SPL-F motherboard supports two serial communication connections. COM Ports 1 and 2 can be used for input/output. The UART provides legacy speeds with a baud rate of up to 115.2 Kbps as well as an advanced speed with baud rates of 250 K, 500 K, or 1 Mb/s, which support high-speed serial communication devices.

# Chapter 2

## Installation

### 2.1 Static-Sensitive Devices

Electrostatic Discharge (ESD) can damage electronic components. To avoid damaging your system board, it is important to handle it very carefully. The following measures are generally sufficient to protect your equipment from ESD.

#### Precautions

- Use a grounded wrist strap designed to prevent static discharge.
- Touch a grounded metal object before removing the board from the antistatic bag.
- Handle the motherboard by its edges only; do not touch its components, peripheral chips, memory modules or gold contacts.
- When handling chips or modules, avoid touching their pins.
- Put the motherboard and peripherals back into their antistatic bags when not in use.
- For grounding purposes, make sure your computer chassis provides excellent conductivity between the power supply, the case, the mounting fasteners and the motherboard.
- Use only the correct type of onboard CMOS battery. Do not install the onboard battery upside down to avoid possible explosion.

#### Unpacking

The motherboard is shipped in antistatic packaging to avoid static damage. When unpacking the motherboard, make sure that the person handling it is static protected.

## 2.2 Processor and Heatsink Installation

The processor (CPU) and processor carrier should be assembled together first to form the processor carrier assembly. This will be attached to the heatsink to form the processor heatsink module (PHM) before being installed onto the CPU socket.

### Notes:

- Use ESD protection.
- Unplug the AC power cord from all power supplies after shutting down the system.
- Check that the plastic protective cover is on the CPU socket and none of the socket pins are bent. If they are, contact your retailer.
- When handling the processor, avoid touching or placing direct pressure on the LGA lands (gold contacts). Improper installation or socket misalignment can cause serious damage to the processor or CPU socket, which may require manufacturer repairs.
- Thermal grease is pre-applied on a new heatsink. No additional thermal grease is needed.
- Refer to the Supermicro website for updates on processor support.
- All graphics in this manual are for illustrations only. Your components may look different.

### The Intel Xeon 81xx/61xx/51xx/41xx/31xx Series Processor

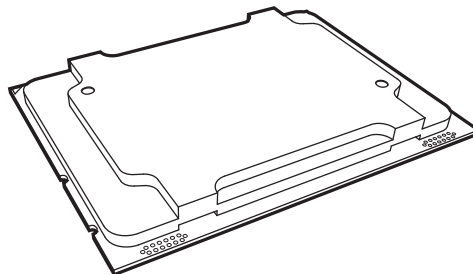

Non-Fabric Model

## Overview of the Processor Carrier Assembly

The processor carrier assembly contains the Intel Xeon Non-Fabric (Non-F) processor and a processor carrier.

### 1. Non-F Processor

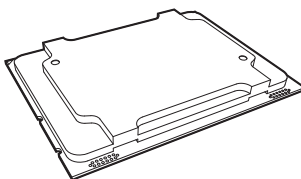

### 2. Processor Carrier

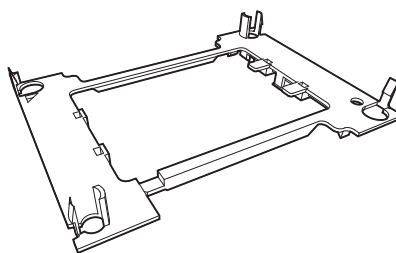

## Overview of the CPU Socket

The CPU socket is protected by a plastic protective cover.

### 1. Plastic Protective Cover

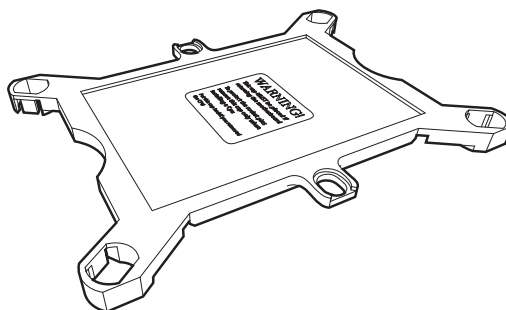

### 2. CPU Socket

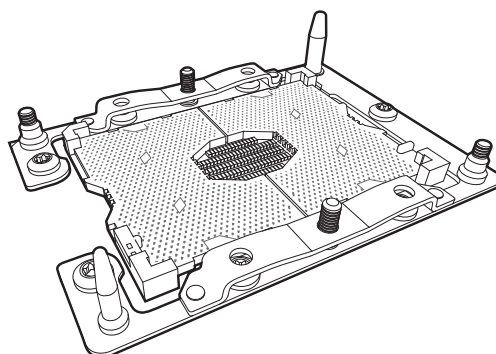

## Overview of the Processor Heatsink Module

The Processor Heatsink Module (PHM) contains a heatsink, a processor carrier, and the Intel Xeon Non-Fabric (Non-F) processor.

### 1. Heatsink with Thermal Grease

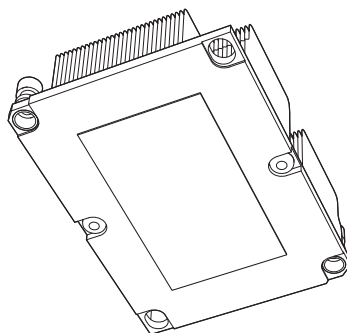

### 2. Processor Carrier

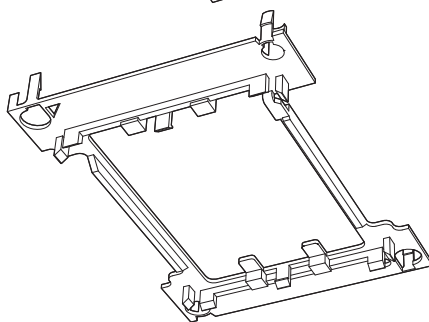

### 3. Non-F Processor

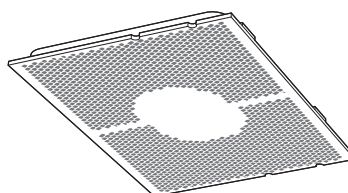

### Processor Heatsink Module

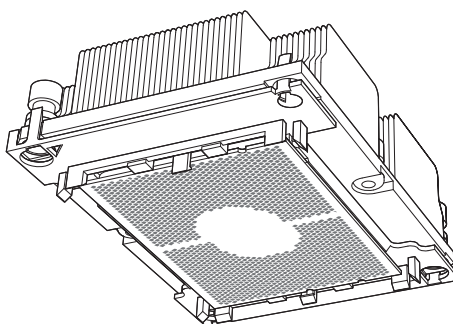

Bottom View

## Creating the Non-F Model Processor Carrier Assembly

To install a Non-F model processor into the processor carrier, follow the steps below:

1. Hold the processor with the LGA lands (gold contacts) facing up. Locate the small, gold triangle in the corner of the processor and the corresponding hollowed triangle on the processor carrier. These triangles indicate pin 1. See the images below.
2. Using the triangles as a guide, carefully align and place Point A of the processor into Point A of the carrier. Then gently flex the other side of the carrier for the processor to fit into Point B.
3. Examine all corners to ensure that the processor is firmly attached to the carrier.

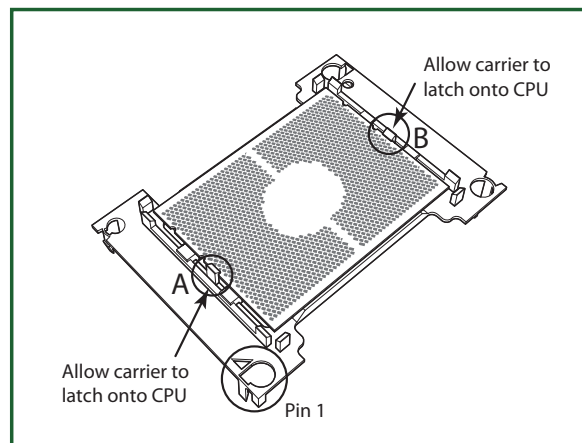
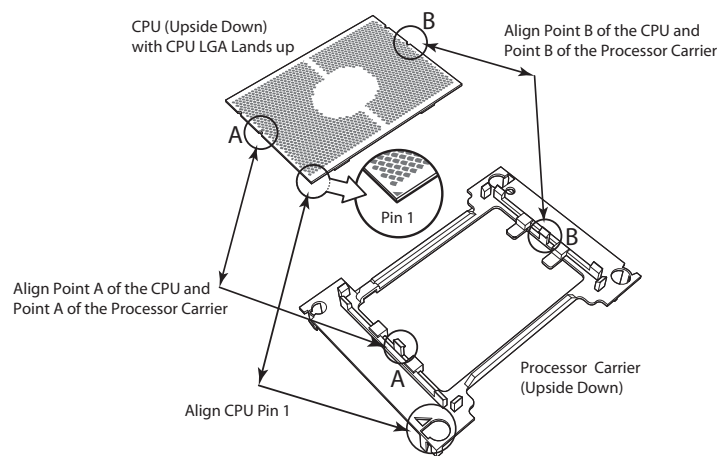

**Processor Carrier Assembly (Non-F Model)**

## Assembling the Processor Heatsink Module

After creating the processor carrier assembly for the Non-F model processor, mount it onto the heatsink to create the processor heatsink module (PHM):

1. Note the label on top of the heatsink, which marks the heatsink mounting holes as 1, 2, 3, and 4. If this is a new heatsink, the thermal grease has been pre-applied on the underside. Otherwise, apply the proper amount of thermal grease.
2. Turn the heatsink over with the thermal grease facing up. Hold the processor carrier assembly so the processor's gold contacts are facing up, then align the triangle on the assembly with hole 1 of the heatsink. Press the processor carrier assembly down. The plastic clips of the assembly will lock outside of holes 1 and 2, while the remaining clips will snap into their corresponding holes.
3. Examine all corners to ensure that the plastic clips on the processor carrier assembly are firmly attached to the heatsink.

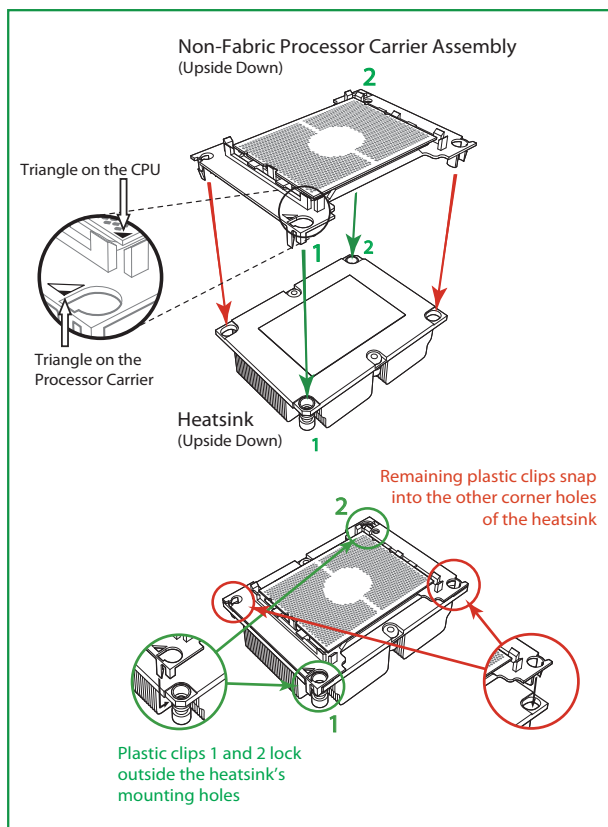

## Preparing the CPU Socket for Installation

This motherboard comes with a plastic protective cover installed on the CPU socket. Remove it from the socket to install the Processor Heatsink Module (PHM). Gently pull up one corner of the plastic protective cover to remove it.

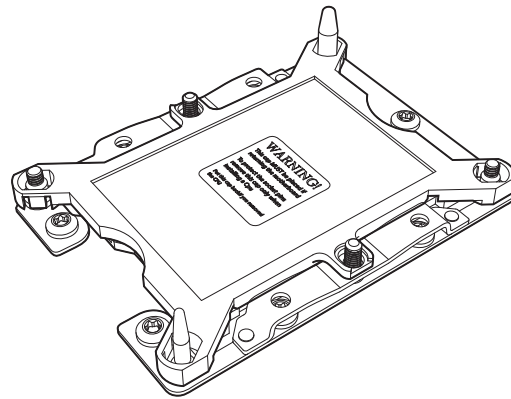

**CPU Socket with Plastic Protective Cover**

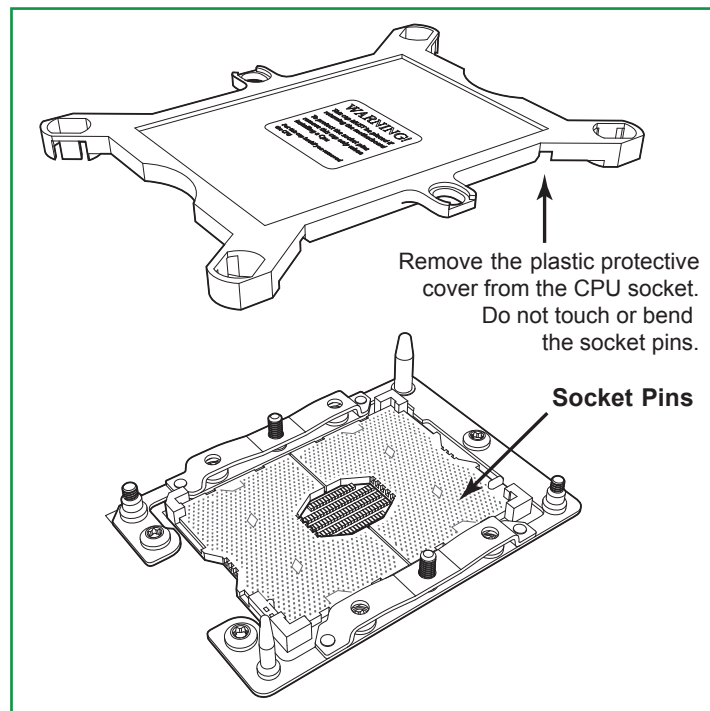

## Installing the Processor Heatsink Module

After assembling the Processor Heatsink Module (PHM), install the PHM onto the CPU socket:

1. Align hole 1 of the heatsink with the printed triangle on the CPU socket. See the left image below.
2. Make sure all four holes of the heatsink are aligned with the socket before gently placing the heatsink on top.
3. With a T30 Torx-bit screwdriver, gradually tighten screws #1 - #4 to ensure even pressure. The order of the screws is shown on the label on top of the heatsink. To avoid damaging the processor or socket, do not use a force greater than 12 lbf-in when tightening the screws.
4. Examine all corners to ensure that the PHM is firmly attached to the socket.

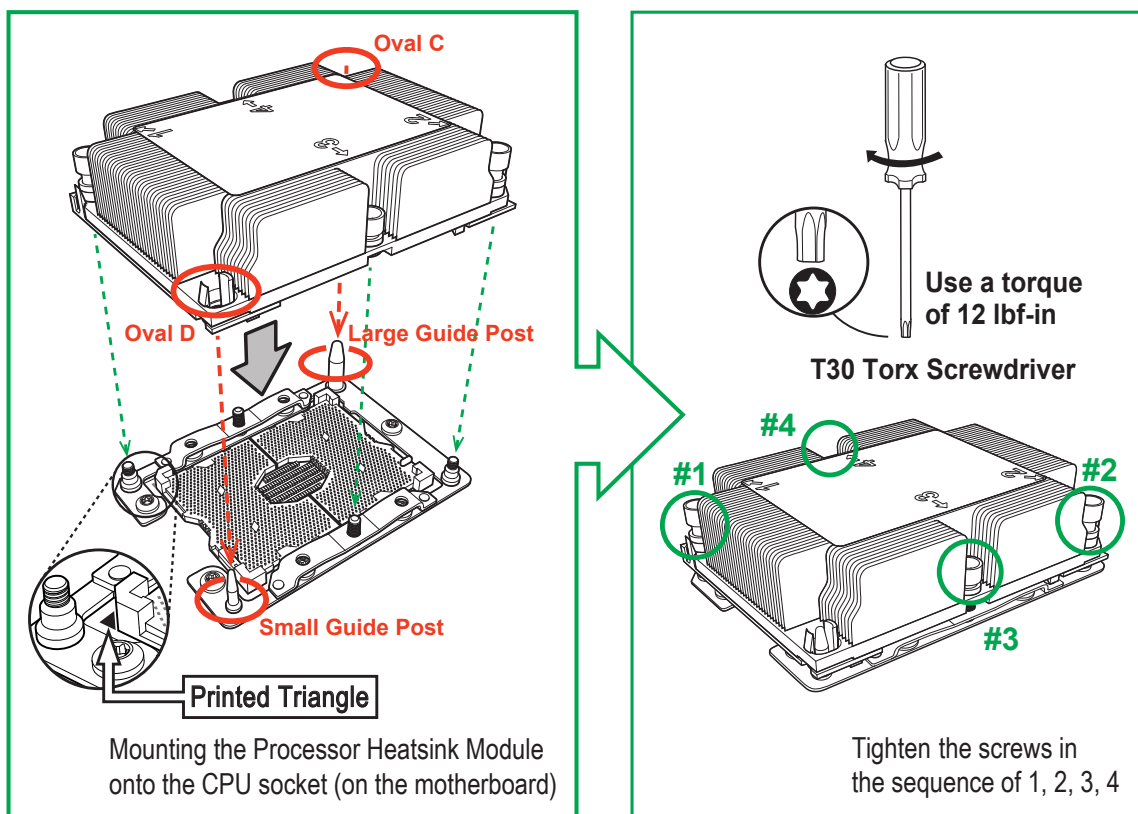

## Removing the Processor Heatsink Module

Before removing the processor heatsink module (PHM) from the motherboard, unplug the AC power cord from all power supplies after shutting down the system. Then follow the steps below:

1. Use a T30 Torx-bit screwdriver to loosen the four screws in a backwards sequence of #4, #3, #2, and #1.
2. Gently lift the PHM upwards to remove it from the socket.

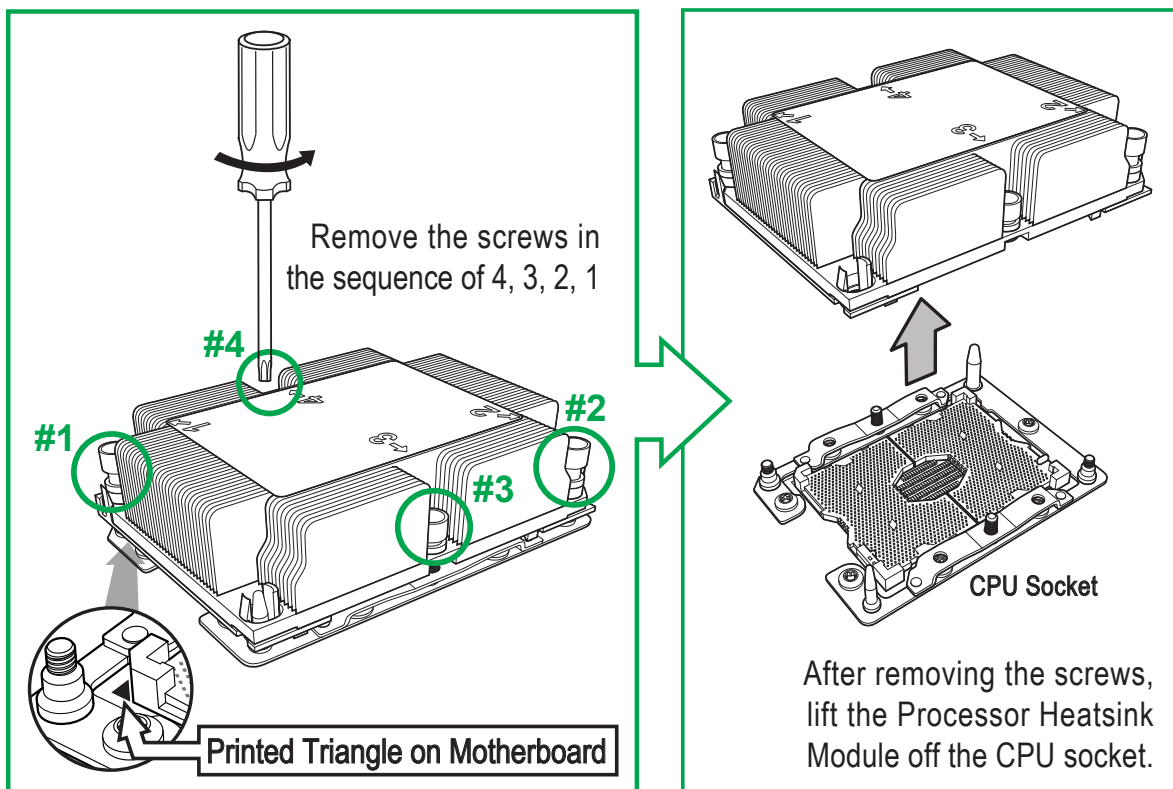

## 2.3 Motherboard Installation

All motherboards have standard mounting holes to fit different types of chassis. Make sure that the locations of all the mounting holes for both the motherboard and the chassis match. Although a chassis may have both plastic and metal mounting fasteners, metal ones are highly recommended because they ground the motherboard to the chassis. Make sure that the metal standoffs click in or are screwed in tightly.

### Tools Needed

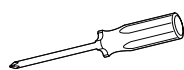

**Phillips Screwdriver (1)**



**Phillips Screws (9)**



**Standoffs (9) Only if Needed**

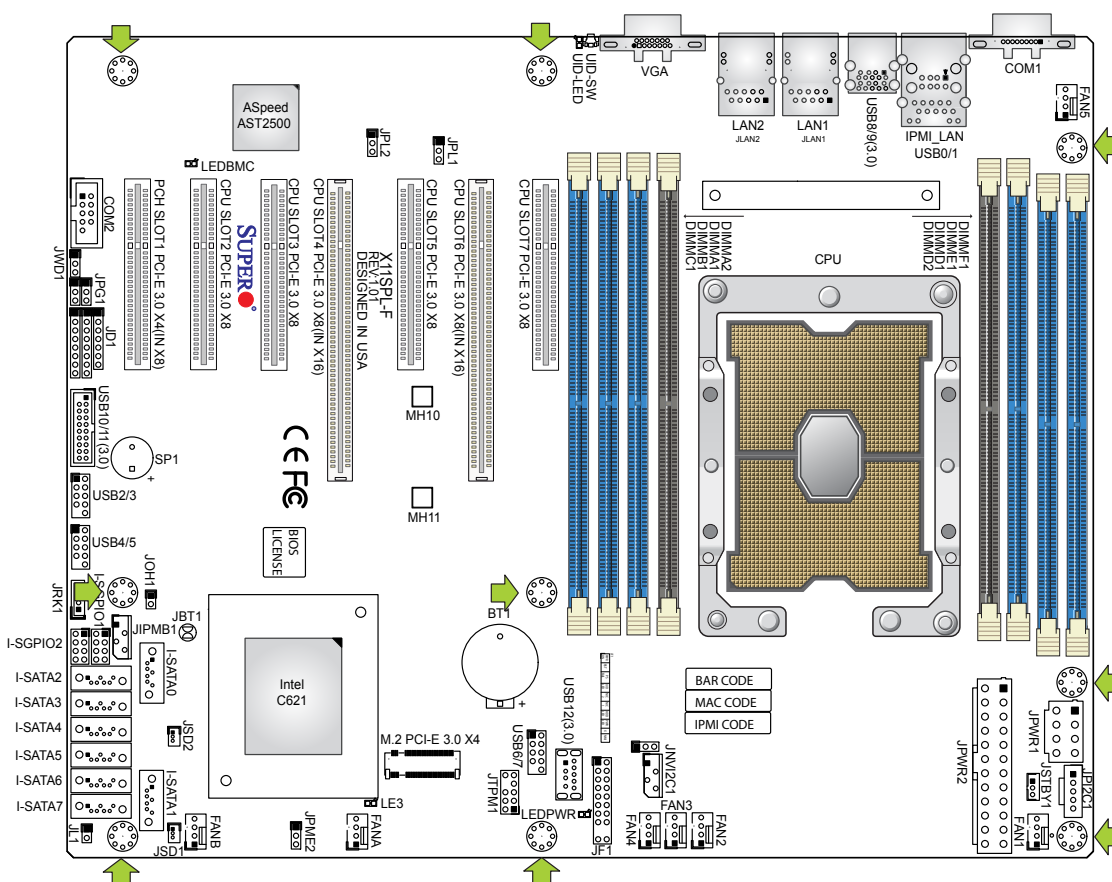

### Location of Mounting Holes



**Note:** 1) To avoid damaging the motherboard and its components, please do not use a force greater than 8 lbf-in on each mounting screw during motherboard installation. 2) Some components are very close to the mounting holes. Please take precautionary measures to avoid damaging these components when installing the motherboard to the chassis.

## Installing the Motherboard

1. Install the I/O shield into the back of the chassis, if applicable.

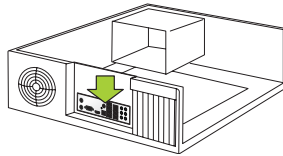

2. Locate the mounting holes on the motherboard. See the previous page for the location.

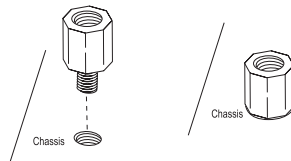

3. Locate the matching mounting holes on the chassis. Align the mounting holes on the motherboard against the mounting holes on the chassis.

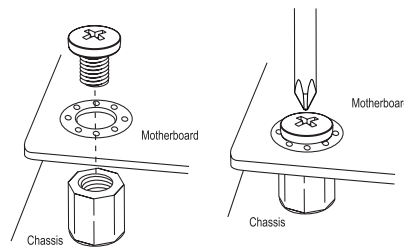

4. Install standoffs in the chassis as needed.
5. Install the motherboard into the chassis carefully to avoid damaging other motherboard components.
6. Using the Phillips screwdriver, insert a Phillips head #6 screw into a mounting hole on the motherboard and its matching mounting hole on the chassis.
7. Repeat Step 5 to insert #6 screws into all mounting holes.
8. Make sure that the motherboard is securely placed in the chassis.

 **Note:** Images displayed are for illustration only. Your chassis or components might look different from those shown in this manual.

## 2.4 Memory Support and Installation



**Note:** Check the Supermicro website for recommended memory modules.



**Important:** Exercise extreme care when installing or removing DIMM modules to prevent any possible damage.

### Memory Support

The X11SPL-F supports up to 256GB of RDIMM, 512GB of LRDIMM, and 1TB of 3DS LRDIMM DDR4 (288-pin) ECC memory with speeds of up to 2666MHz in eight memory slots. Refer to the tables below for the recommended DIMM population order and additional memory information.

1 CPU, 8-DIMM Slots	
Number of DIMMs	Memory Population Sequence
1	DIMMA1
2	DIMMA1 / DIMMD1
3	DIMMC1 / DIMMB1 / DIMMA1
4	DIMMB1 / DIMMA1 / DIMMD1 / DIMME1
5 (Unbalanced: Not Recommended)	DIMMC1 / DIMMB1 / DIMMA1 / DIMMD1 / DIMME1
6	DIMMC1 / DIMMB1 / DIMMA1 / DIMMD1 / DIMME1 / DIMMF1
7 (Unbalanced: Not Recommended)	DIMMC1 / DIMMB1 / DIMMA1 / DIMMA2 / DIMMD1 / DIMME1 / DIMMF1
8	DIMMC1 / DIMMB1 / DIMMA1 / DIMMA2 / DIMMD2 / DIMMD1 / DIMME1 / DIMMF1

DIMM Type	Ranks Per DIMM and Data Width	DIMM Capacity (GB)		Speed (MT/s), Voltage (V), Slot Per Channel (SPC), and DIMM Per Channel (DPC)		
				1 Slot Per Channel	2 Slots Per Channel	
		DRAM Density		1DPC	1DPC	2DPC
		4GB	8GB	1.2V	1.2V	1.2V
RDIMM	SRx4	8GB	16GB	2666	2666	2666
RDIMM	SRx8	4GB	8GB			
RDIMM	DRx8	8GB	16GB			
RDIMM	DRx4	16GB	32GB			
RDIMM 3DS	QRx4	N/A	2H-64GB			
	8Rx4	N/A	4H-128GB			
LRDIMM	QRx4	32GB	64GB			
LRDIMM 3DS	QRx4	N/A	2H-64GB			
	8Rx4	N/A	4H-128GB			

## General Guidelines for Optimizing Memory Performance

- The blue slots must be populated first.
- Only populate DIMMA2 and DIMMD2 if the extra memory support is needed.
- Always use DDR4 memory of the same type, size and speed.
- Mixed DIMM speeds can be installed. However, all DIMMs will run at the speed of the slowest DIMM.
- The motherboard will support odd-numbered modules (one or three modules installed). However, to achieve the best memory performance, a balanced memory population is recommended.

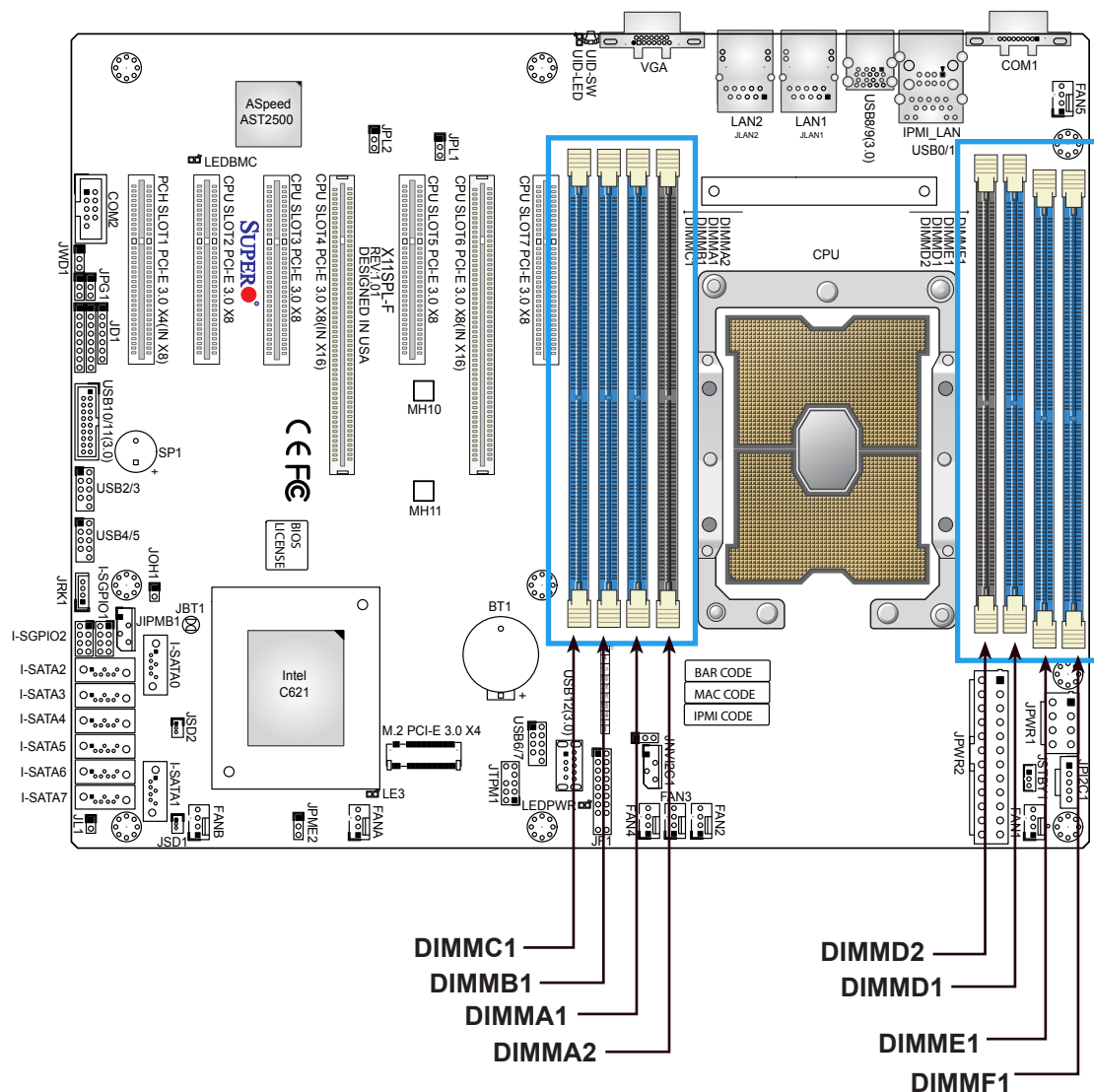

## DIMM Installation

1. Insert the desired number of DIMMs into the memory slots based on the Recommended Memory Population Guide table on pg. 32.
2. Push the release tabs outwards on both ends of the DIMM slot to unlock it.
3. Align the key of the DIMM module with the receptive point on the memory slot.
4. Align the notches on both ends of the module against the receptive points on the ends of the slot.
5. Press the notches on both ends of the module straight down into the slot until the module snaps into place.
6. Press the release tabs to the lock positions to secure the DIMM module into the slot.

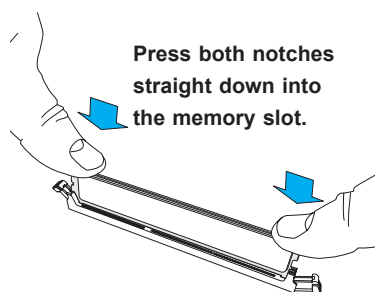
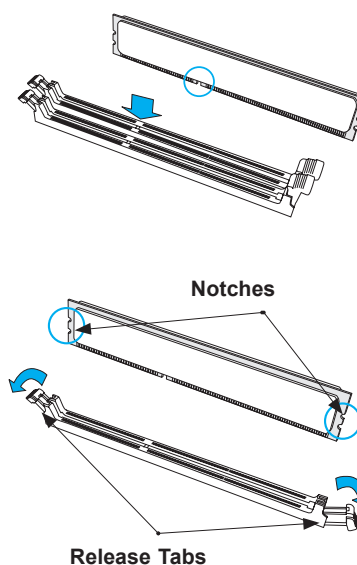
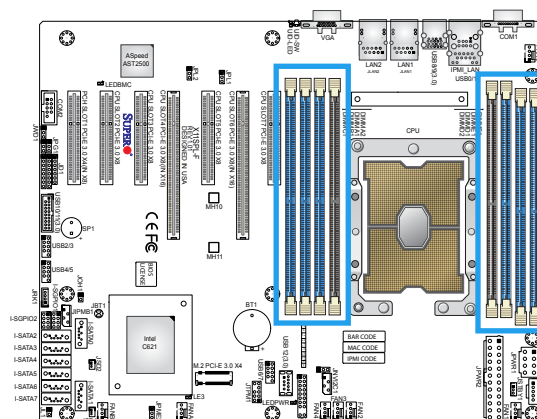

## DIMM Removal

Press both release tabs on the ends of the DIMM module to unlock it. Once the DIMM module is loosened, remove it from the memory slot.

## 2.5 Rear I/O Ports

See Figure 2-1 below for the locations and descriptions of the various I/O ports on the rear of the motherboard.

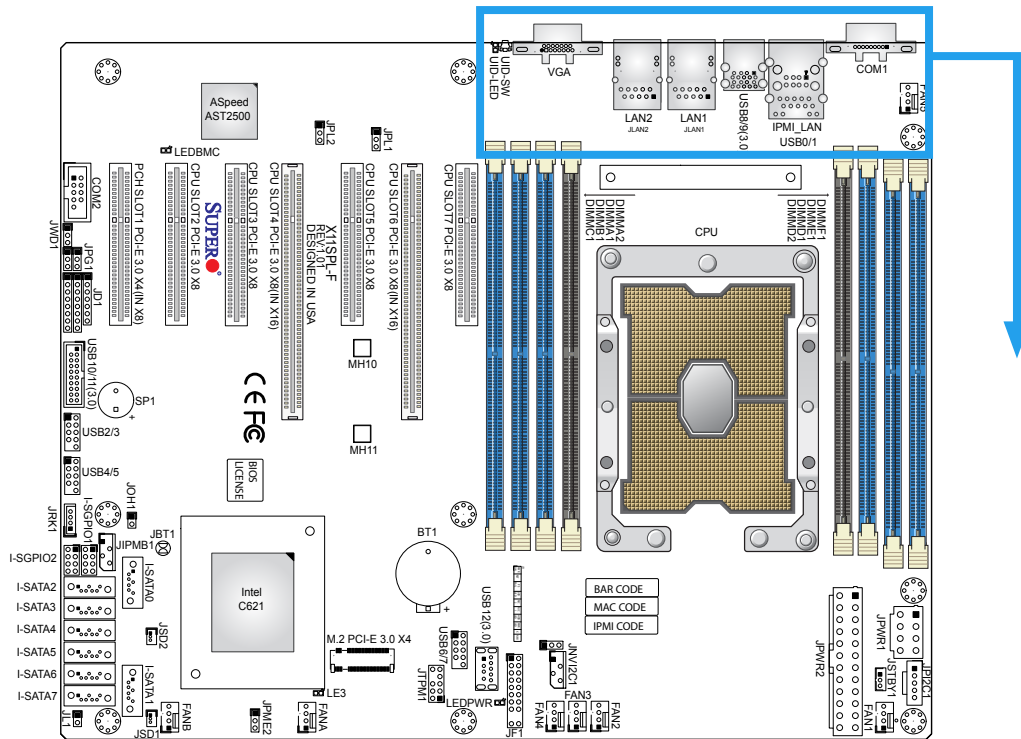
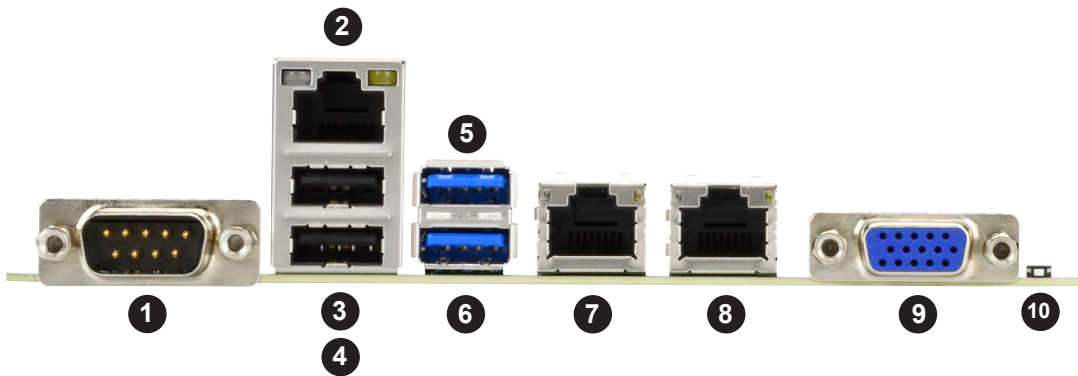

Figure 2-1. I/O Port Locations and Definitions



#	Description	#	Description
1	COM Port 1	6	USB8 (3.0)
2	Dedicated IPMI LAN	7	LAN1
3	USB1	8	LAN2
4	USB0	9	VGA Port
5	USB9 (3.0)	10	UID Switch

### COM Ports

Two COM connections (COM1, COM2) are located on the motherboard. COM1 is located on the I/O back panel. COM2 is located next to PCI-E Slot 1.

COM Port Pin Definitions			
Pin#	Definition	Pin#	Definition
1	DCD	6	DSR
2	RXD	7	RTS
3	TXD	8	CTS
4	DTR	9	RI
5	Ground	10	N/A

### VGA Port

A video (VGA) port is located next to LAN2 on the I/O back panel. Refer to the board layout below for the location.

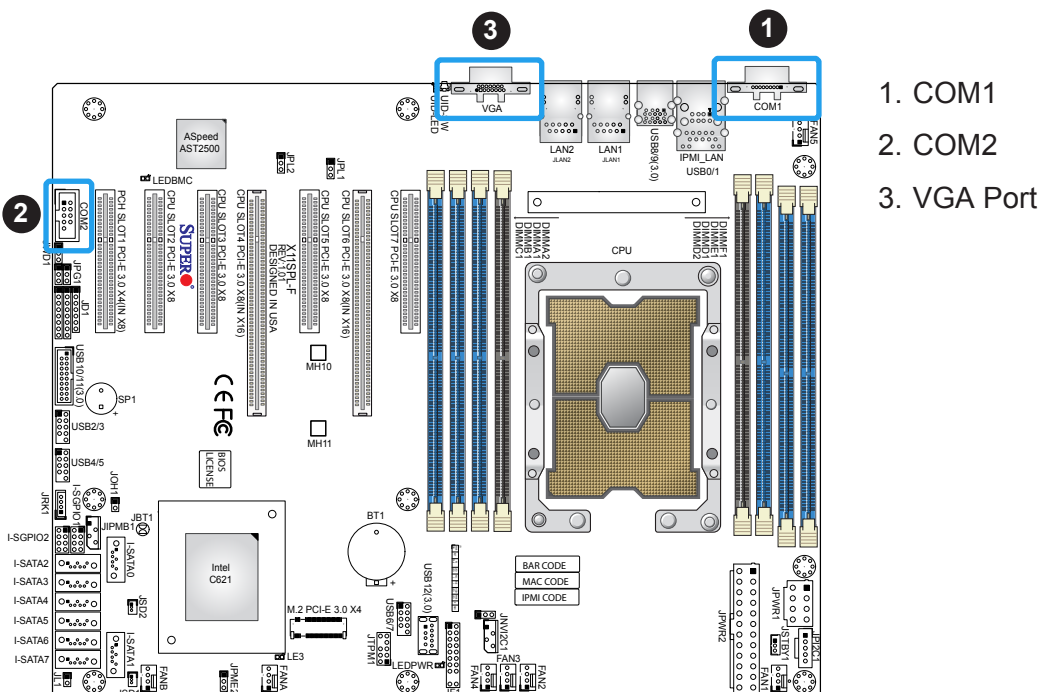

## LAN Ports

Two Gigabit Ethernet ports (LAN1, LAN2) are located on the I/O back panel. In addition, a dedicated IPMI LAN is located above the USB0/1 ports on the back panel. All of these ports accept RJ45 cables. Please refer to the LED Indicator section for LAN LED information.

LAN Port Pin Definition			
Pin#	Definition	Pin#	Definition
9	TD1+	13	YEL+
10	TD1-	14	YEL-
7	TD2+		
8	TD2-		
5	TD3+	11	GRN+/ORG-
6	TD3-	12	GRN-/ORG+
3	TD4+	15	CG1
4	TD4-	16	CG2
2	VCC	1	GND

IPMI LAN Pin Definition			
Pin#	Definition	Pin#	Definition
11	TX1-	20	YEL+
10	TX1+	19	YEL-
13	TX2-		
12	TX2+	22	ORG-/GRN+
15	TX3-	21	ORG+/GRN-
14	TX3+		
17	TX4-	23	SGND
16	TX4+	24	SGND
9	VCC	25	SGND
18	GND	26	SGND

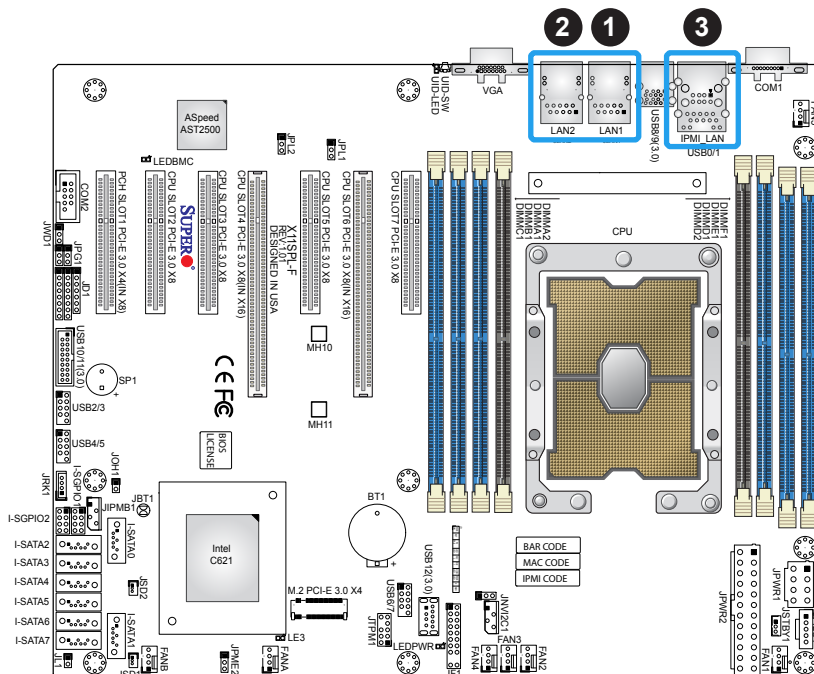

1. LAN1
2. LAN2
3. IPMI LAN

## Universal Serial Bus (USB) Ports

There are two USB 2.0 ports (USB0/1) and two USB 3.0 ports (USB8/9) located on the I/O back panel. The motherboard also has three front accessible USB 2.0 headers (USB2/3, USB4/5, and USB6/7) and one front accessible USB 3.0 header (USB10/11). The USB12 header is USB 3.0 Type-A. The onboard headers can be used to provide front side USB access with a cable (not included).

Back Panel USB 0/1 (2.0) Pin Definitions			
Pin#	Definition	Pin#	Definition
1	+5V	5	+5V
2	USB_N	6	USB_N
3	USB_P	7	USB_P
4	Ground	8	Ground

Front Panel USB 2/3, 4/5, and 6/7 (2.0) Pin Definitions			
Pin#	Definition	Pin#	Definition
1	+5V	2	+5V
3	USB_N	4	USB_N
5	USB_P	6	USB_P
7	Ground	8	Ground
9	Key	10	NC

Back Panel USB 8/9 (3.0) Pin Definitions			
Pin#	Definition	Pin#	Definition
A1	VBUS	B1	Power
A2	D-	B2	USB_N
A3	D+	B3	USB_P
A4	GND	B4	GND
A5	Stda_SSRX-	B5	USB3_RN
A6	Stda_SSRX+	B6	USB3_RP
A7	GND	B7	GND
A8	Stda_SSTX-	B8	USB3_TN
A9	Stda_SSTX+	B9	USB3_TP

Front Panel USB 10/11 (3.0) Pin Definitions			
Pin#	Definition	Pin#	Definition
1	VBUS	19	Power
2	Stda_SSRX-	18	USB3_RN
3	Stda_SSRX+	17	USB3_RP
4	GND	16	GND
5	Stda_SSTX-	15	USB3_TN
6	Stda_SSTX+	14	USB3_TP
7	GND	13	GND
8	D-	12	USB_N
9	D+	11	USB_P
10	GND	X	

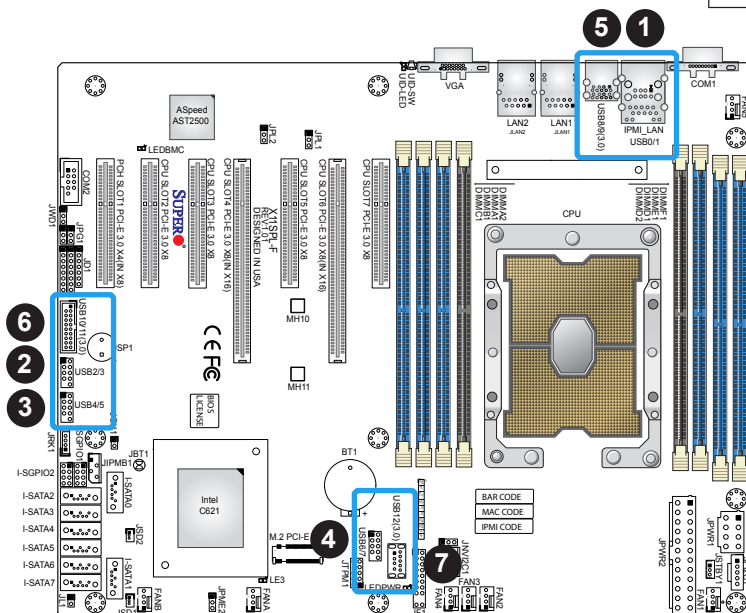

Type A USB 12 (3.0) Pin Definitions			
Pin#	Definition	Pin#	Definition
1	VBUS	5	SSRX-
2	USB_N	6	SSRX+
3	USB_P	7	GND
4	Ground	8	SSTX-
		9	SSTX+

1. USB0/1
2. USB2/3
3. USB4/5
4. USB6/7
5. USB8/9
6. USB10/11
7. USB12

## Unit Identifier Switch/Rear LED Indicator

A Unit Identifier (UID) Switch (UID-SW) and a rear LED Indicator (UID-LED) are located on the I/O back panel. When the user presses the UID switch, the UID LED indicator will be turned on. Press the UID switch again to turn off the UID LED. The UID indicator provides easy identification of a system unit that may be in need of service.

 **Note:** UID can also be triggered via IPMI on the motherboard. For more information on IPMI, please refer to the IPMI User's Guide posted on our website at <http://www.supermicro.com>.

UID Switch Pin Definitions	
Pin#	Definitions
1	Button In
2	Ground
3	Ground
4	Ground
5	Ground

UID LED Status	
Color/State	Status
Blue: On	Unit Identified

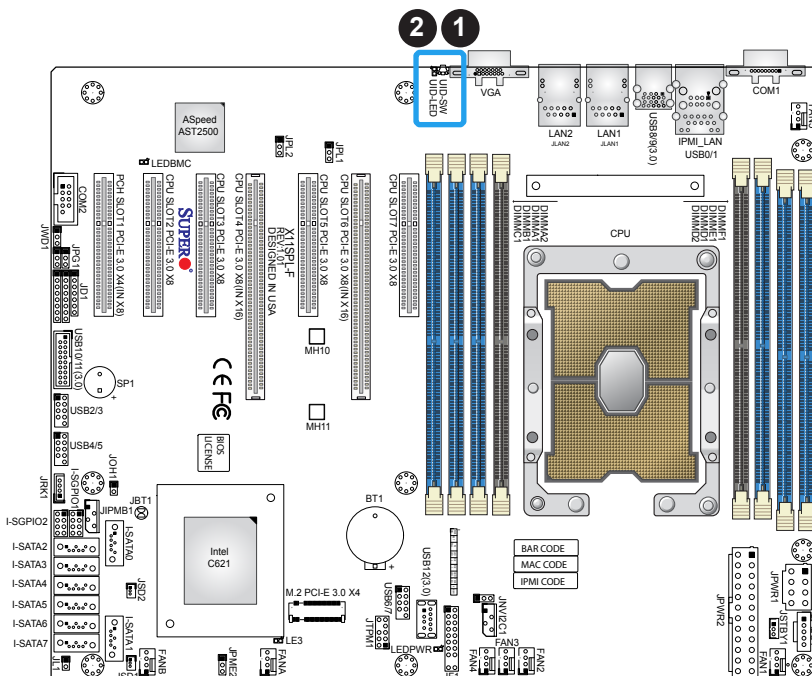

1. UID Switch
2. UID LED

## 2.6 Front Control Panel

JF1 contains header pins for various buttons and indicators that are normally located on a control panel at the front of the chassis. These connectors are designed specifically for use with Supermicro chassis. See the figure below for the descriptions of the front control panel buttons and LED indicators.

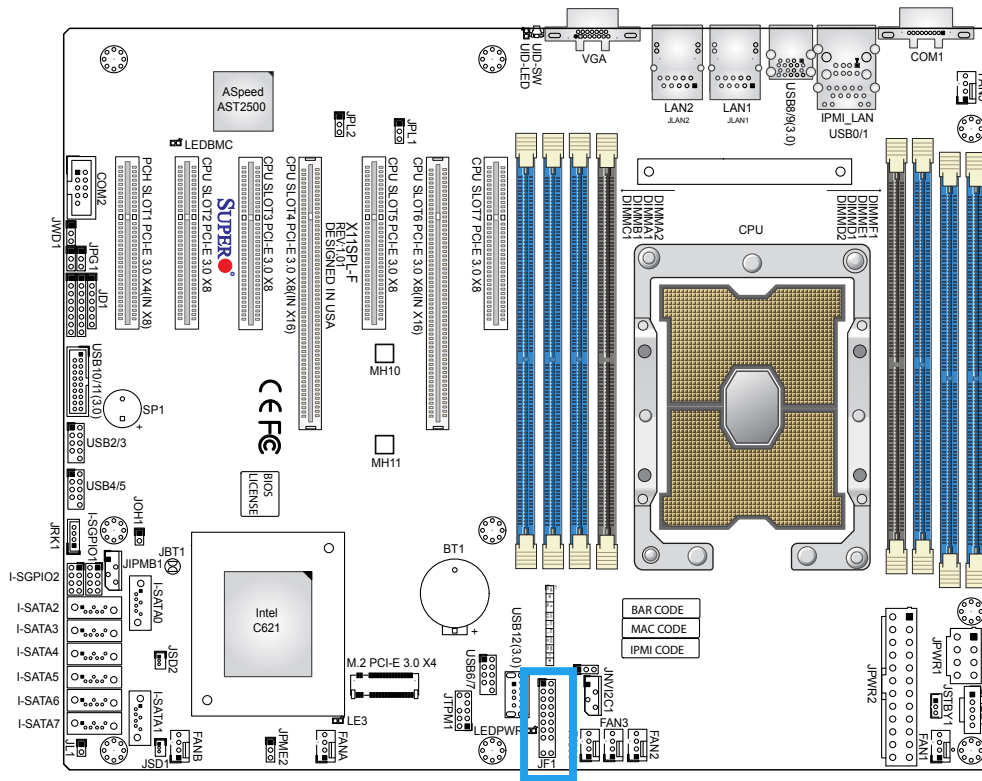
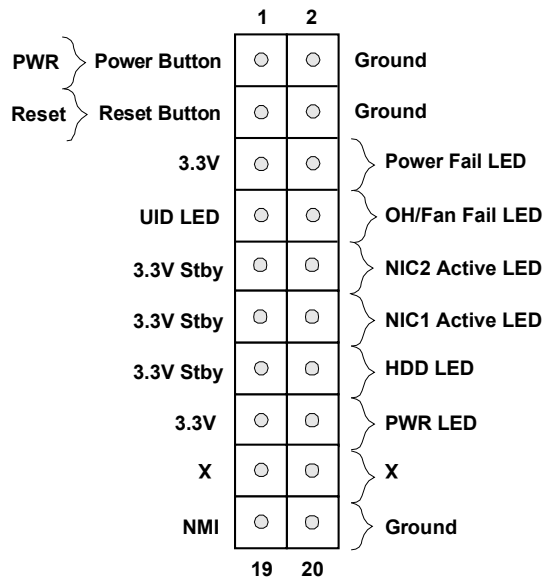

Figure 2-2. JF1 Header Pins



## Power Button

The Power Button connection is located on pins 1 and 2 of JF1. Momentarily contacting both pins will power on/off the system. This button can also be configured to function as a suspend button (with a setting in the BIOS - see Chapter 4). To turn off the power when the system is in suspend mode, press the button for 4 seconds or longer. Refer to the table below for pin definitions.

Power Button Pin Definitions (JF1)	
Pins	Definition
1	Signal
2	Ground

## Reset Button

The Reset Button connection is located on pins 3 and 4 of JF1. Attach it to a hardware reset switch on the computer case to reset the system. Refer to the table below for pin definitions.

Reset Button Pin Definitions (JF1)	
Pins	Definition
3	Reset
4	Ground

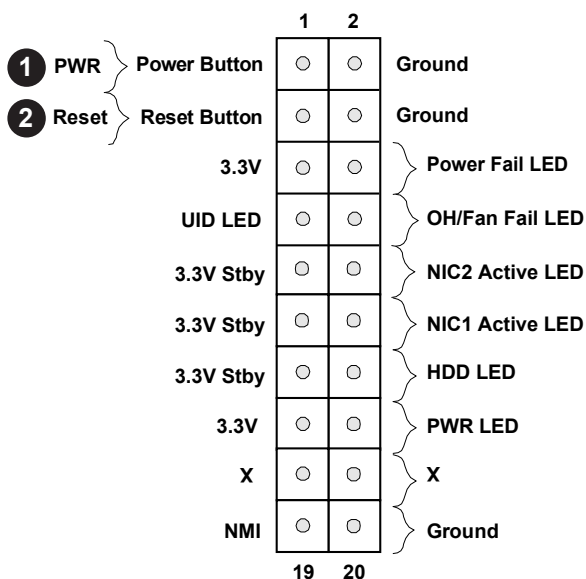

1. PWR Button
2. Reset Button

### Power Fail LED

The Power Fail LED connection is located on pins 5 and 6 of JF1. Refer to the table below for pin definitions.

Power Fail LED Pin Definitions (JF1)	
Pin#	Definition
5	3.3V
6	PWR Supply Fail

### Overheat (OH)/Fan Fail

Connect an LED cable to pins 7 and 8 of the Front Control Panel to use the Overheat/Fan Fail LED connections. The LED on pin 8 provides warnings of overheat or fan failure. Refer to the tables below for pin definitions.

OH/Fan Fail Indicator Status	
State	Definition
Off	Normal
On	Overheat
Flashing	Fan Fail

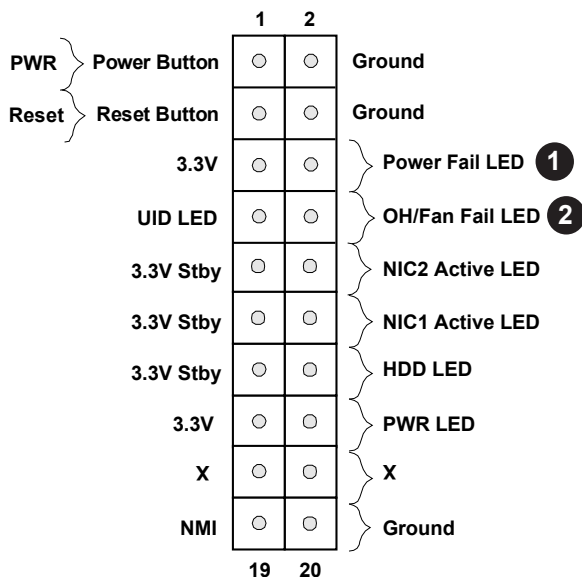

- 1. Power Fail LED
- 2. OH/Fan Fail LED

## NIC1/NIC2 (LAN1/LAN2)

The Network Interface Controller (NIC) LED connection for LAN port 1 is located on pins 11 and 12 of JF1, and LAN port 2 is on pins 9 and 10. Attach the NIC LED cables here to display network activity. Refer to the table below for pin definitions.

LAN1/LAN2 LED Pin Definitions (JF1)	
Pin#	Definition
9	3.3V Stby
10	NIC 2 Activity LED
11	3.3V Stby
12	NIC 1 Activity LED

## HDD LED

The HDD LED connection is located on pins 13 and 14 of JF1. Attach a cable to pin 14 to show hard drive activity status. Refer to the table below for pin definitions.

HDD LED Pin Definitions (JF1)	
Pins	Definition
13	3.3V Stbby
14	HDD Active

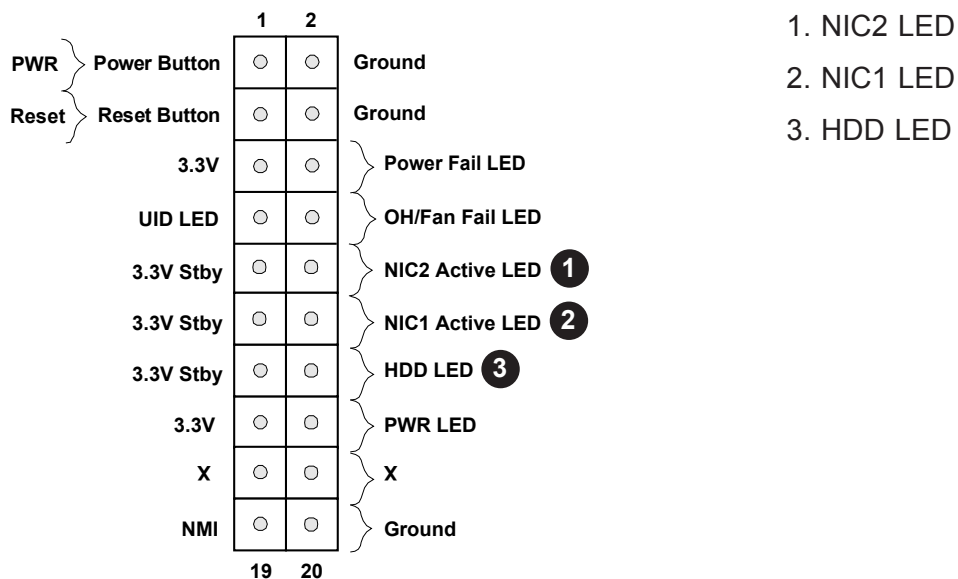

### Power LED

The Power LED connection is located on pins 15 and 16 of JF1. Refer to the table below for pin definitions.

Power LED Pin Definitions (JF1)	
Pins	Definition
15	3.3V
16	PWR LED

### NMI Button

The non-maskable interrupt (NMI) button header is located on pins 19 and 20 of JF1. Refer to the table below for pin definitions.

NMI Button Pin Definitions (JF1)	
Pins	Definition
19	Control
20	Ground

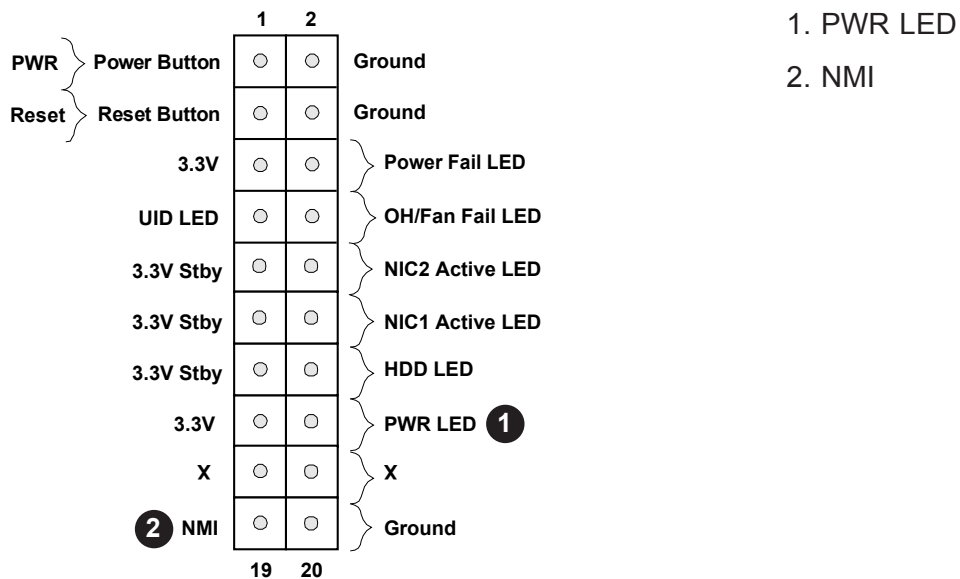

1. PWR LED
2. NMI

## 2.7 Connectors

### Power Connections

#### ATX Power Supply Connector

The 24-pin power supply connector (JPWR2) meets the ATX SSI EPS 12V specification. You must also connect the 8-pin (JPWR1) processor power connector to the power supply.

ATX Power 24-pin Connector Pin Definitions			
Pin#	Definition	Pin#	Definition
13	+3.3V	1	+3.3V
14	-12V	2	+3.3V
15	Ground	3	Ground
16	PS_ON	4	+5V
17	Ground	5	Ground
18	Ground	6	+5V
19	Ground	7	Ground
20	Res (NC)	8	PWR_OK
21	+5V	9	5VSB
22	+5V	10	+12V
23	+5V	11	+12V
24	Ground	12	+3.3V

#### Required Connection

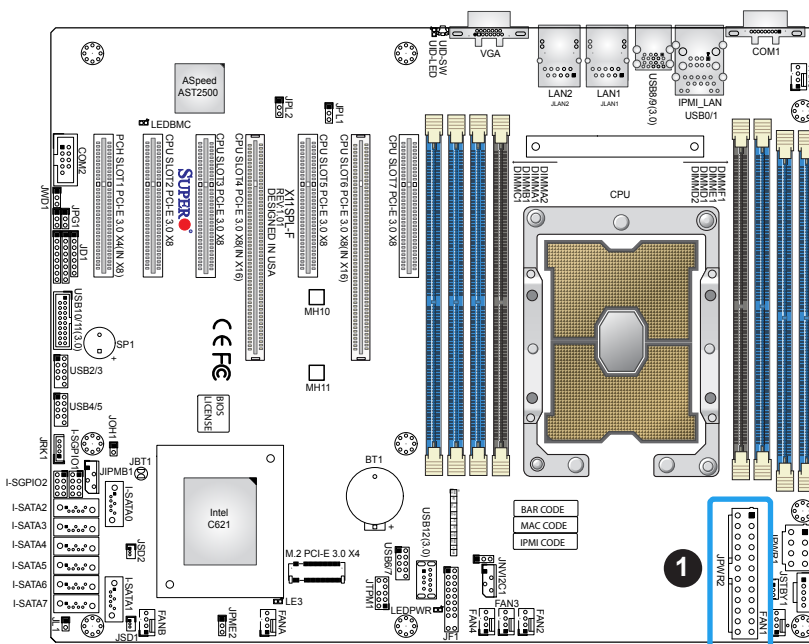

#### 1. 24-Pin ATX PWR

### 8-Pin Power Connector

JPWR1 is an 8-pin 12V DC power input for the CPU that must be connected to the power supply. Refer to the table below for pin definitions..

8-pin Power Pin Definitions	
Pin#	Definition
1 - 4	Ground
5 - 8	P12V (12V Power)

Required Connection



**Important:** To provide adequate power supply to the motherboard, be sure to connect the 24-pin ATX PWR and the 8-pin PWR connectors to the power supply. Failure to do so may void the manufacturer warranty on your power supply and motherboard.

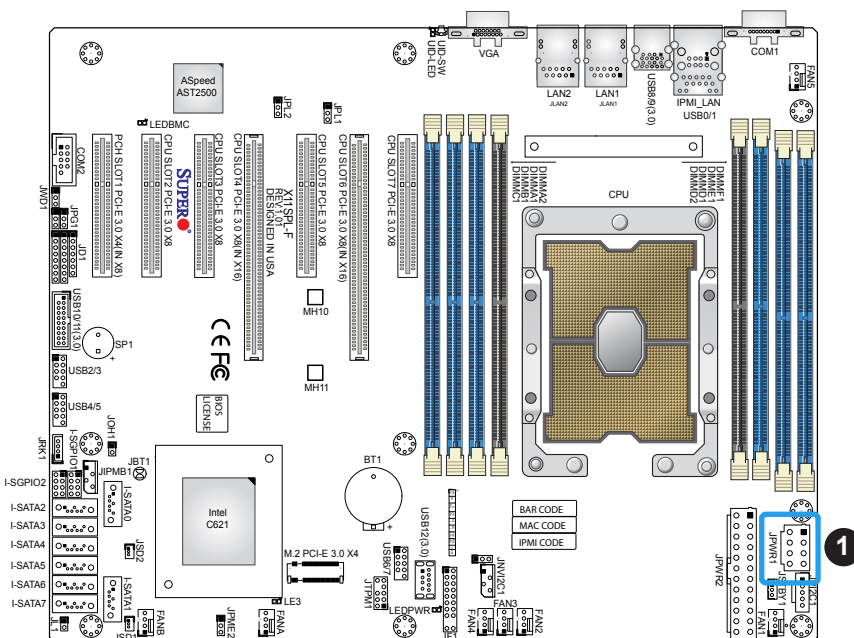

1. 8-Pin PWR

## Headers

### Fan Headers

There are seven 4-pin fan headers (FAN1~FAN5, FANA/FANB) on the motherboard. All these 4-pin fan headers are backwards compatible with the traditional 3-pin fans. However, fan speed control is available for 4-pin fans only by Thermal Management via the IPMI 2.0 interface. Refer to the table below for pin definitions.

Fan Header Pin Definitions	
Pin#	Definition
1	Ground (Black)
2	2.5A/+12V (Red)
3	Tachometer
4	PWM_Control

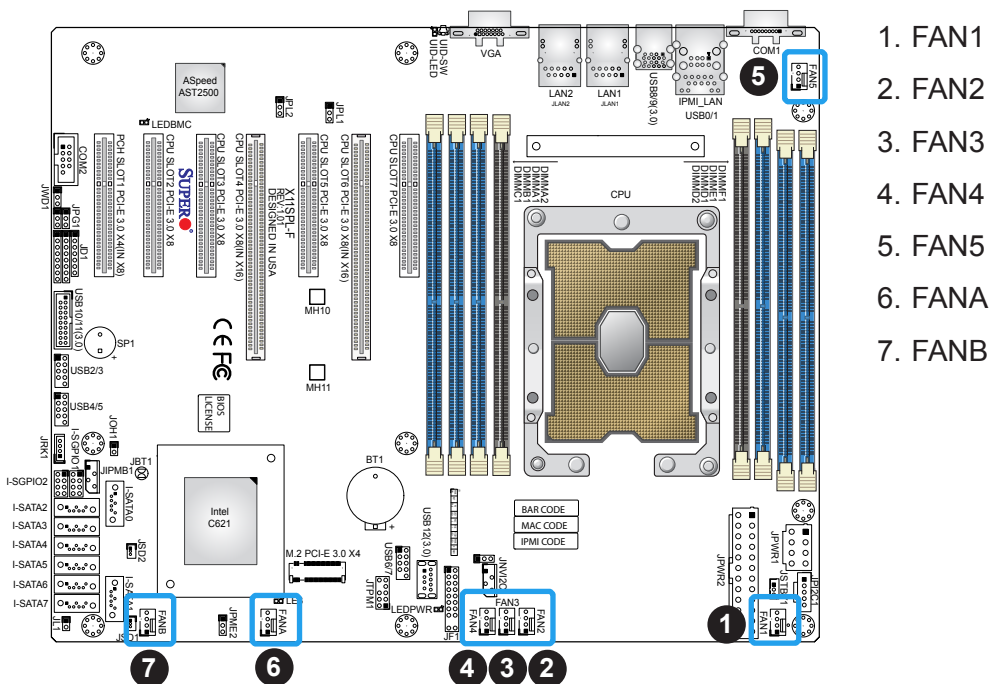

### SGPIO Headers

There are two Serial Link General Purpose Input/Output (I-SGPIO1, I-SGPIO2) headers located on the motherboard. I-SGPIO is for SATA use. Refer to the table below for pin definitions.

SGPIO Header Pin Definitions			
Pin#	Definition	Pin#	Definition
1	NC	2	NC
3	Ground	4	Data
5	Load	6	Ground
7	Clock	8	NC

NC = No Connection

### Disk-On-Module Power Connectors

Two power connectors for SATA DOM (Disk-On-Module) devices are located at JSD1/JSD2. Connect appropriate cables here to provide power support for your Serial Link DOM devices.

DOM Power Pin Definitions	
Pin#	Definition
1	5V
2	Ground
3	Ground

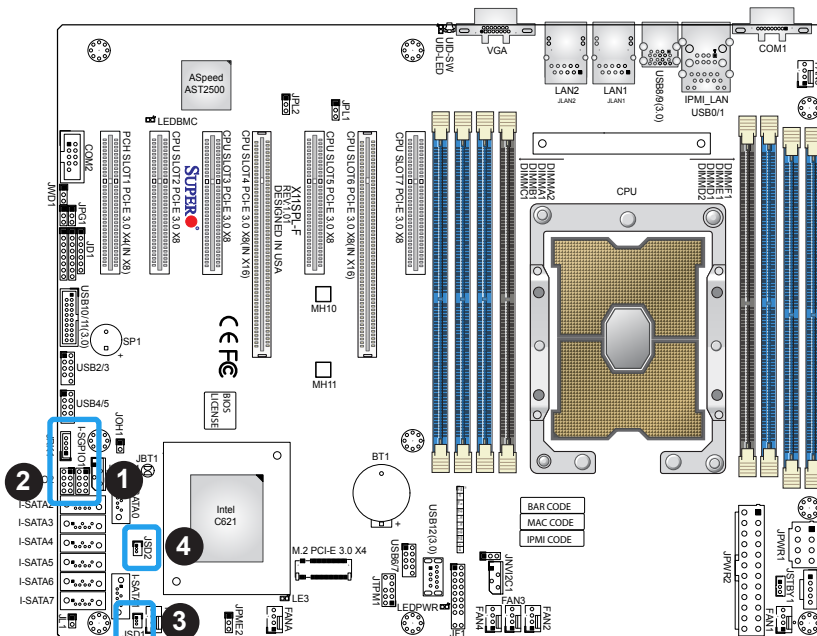

1. I-SGPIO1
2. I-SGPIO2
3. JSD1 (DOM PWR)
4. JSD2 (DOM PWR)

## TPM/Port 80 Header

A Trusted Platform Module (TPM)/Port 80 header is located at JTPM1 to provide TPM support and Port 80 connection. Use this header to enhance system performance and data security. Refer to the table below for pin definitions. Please go to the following link for more information on the TPM: <http://www.supermicro.com/manuals/other/TPM.pdf>.

Trusted Platform Module Header Pin Definitions			
Pin#	Definition	Pin#	Definition
1	+3.3V	2	SPI_CS#
3	RESET#	4	SPI_MISO
5	SPI_CLK	6	GND
7	SPI_MOSI	8	NC
9	+3.3V Stdbby	10	SPI_IRQ#

## M.2 Slot

M.2 is formerly known as Next Generation Form Factor (NGFF). The M.2 slot is designed for internal mounting devices. The X11SPL-F motherboard deploys an M key dedicated for SSD devices with the ultimate performance capability in a PCI-Express 3.0 x4 interface for native PCI-E SSD support. It can also support SATA devices.

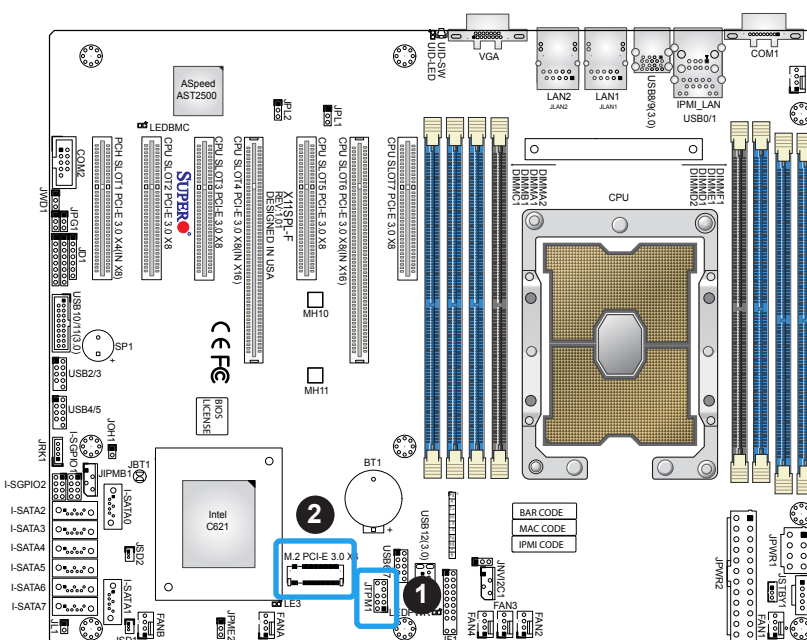

1. TPM Header
2. M.2 Slot

### Standby Power

The Standby Power header is located at JSTBY1 on the motherboard. You must have a card with a Standby Power connector and a cable to use this feature. Refer to the table below for pin definitions.

Standby Power Pin Definitions	
Pin#	Definition
1	+5V Standby
2	Ground
3	No Connection

### Internal Speaker/Buzzer

The Internal Speaker/Buzzer (SP1) is used to provide audible indications for various beep codes. Refer to the table below for pin definitions.

Internal Buzzer Pin Definitions		
Pin#	Definition	
1	Pos (+)	Beep In
2	Neg (-)	Alarm Speaker

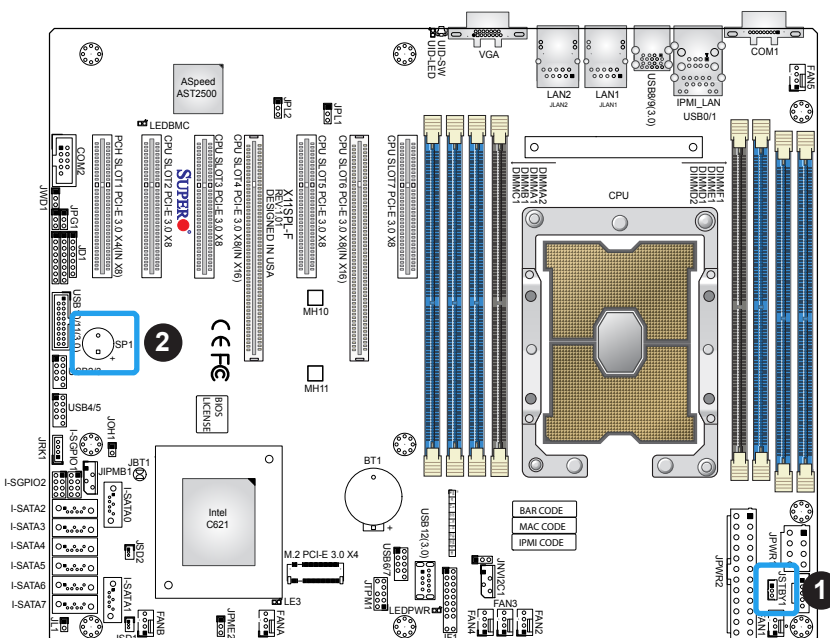

1. Standby Power
2. Internal Speaker

## Power SMB (I<sup>2</sup>C) Header

The Power System Management Bus (I<sup>2</sup>C) connector (JPI<sup>2</sup>C1) monitors the power supply, fan, and system temperatures. Refer to the table below for pin definitions.

Power SMB Header Pin Definitions	
Pin#	Definition
1	Clock
2	Data
3	PMBUS_Alert
4	Ground
5	+3.3V

## 4-pin BMC External I<sup>2</sup>C Header

A System Management Bus header for IPMI 2.0 is located at JIPMB1. Connect the appropriate cable here to use the IPMB I<sup>2</sup>C connection on your system. Refer to the table below for pin definitions.

External I <sup>2</sup> C Header Pin Definitions	
Pin#	Definition
1	Data
2	Ground
3	Clock
4	No Connection

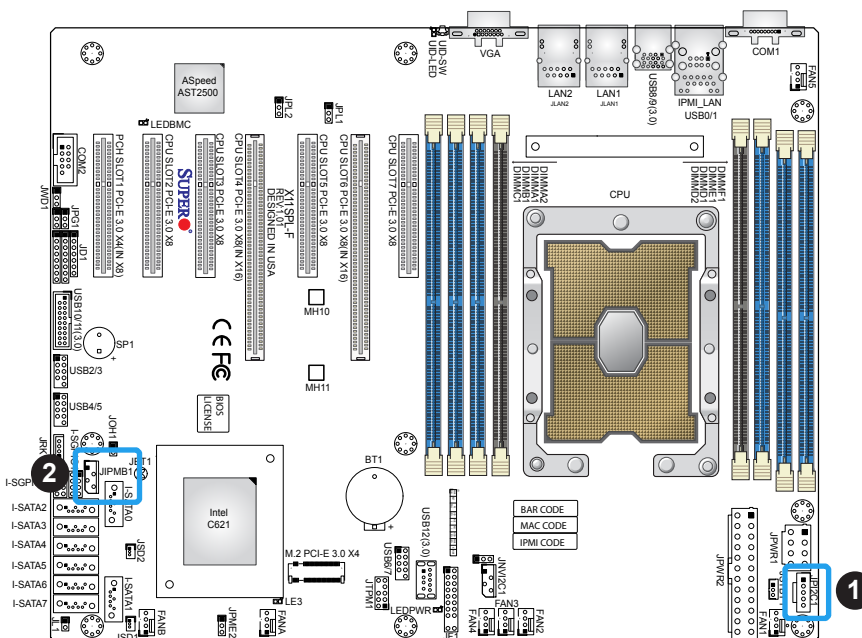

1. Power SMB Header
2. BMC External Header

### Chassis Intrusion

A Chassis Intrusion header is located at JL1 on the motherboard. Attach the appropriate cable from the chassis to inform you of a chassis intrusion when the chassis is opened. Refer to the table below for pin definitions.

Chassis Intrusion Pin Definitions	
Pin#	Definition
1	Intrusion Input
2	Ground

### NVMe I<sup>2</sup>C Header

Connector JNV1<sup>2</sup>C1 is a management header for the Supermicro AOC NVMe PCI-E peripheral cards. Please connect the I<sup>2</sup>C cable to this connector.

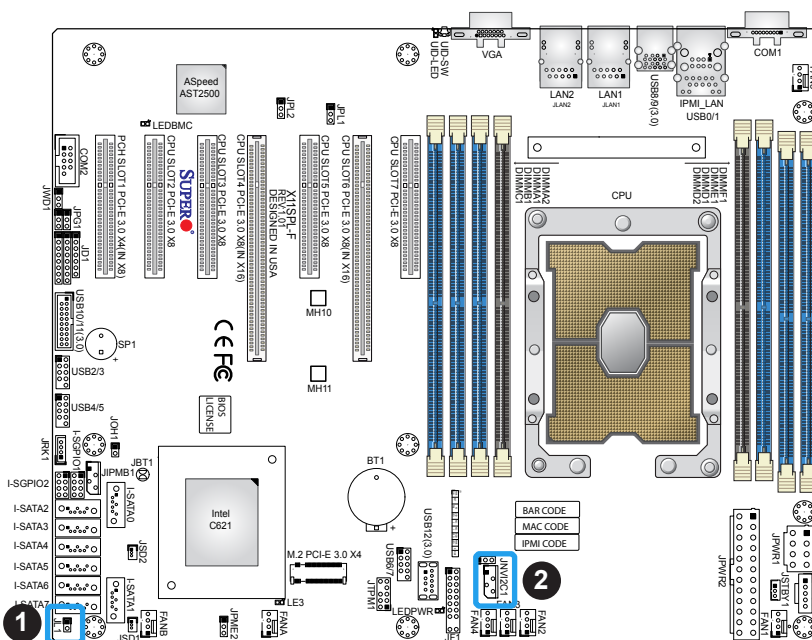

1. Chassis Intrusion
2. NVMe I<sup>2</sup>C Header

## Power LED/Speaker

Pins 1-3 of JD1 are used for power LED indication, and pins 4-7 are for the speaker. Please note that the speaker connector pins (4-7) are used with an external speaker. If you wish to use the onboard speaker, you should close pins 6-7 with a cap. Refer to the tables below for pin definitions.

PWR LED Connector Pin Definitions	
Pin#	Signal
1	JD1_PIN1
2	FP_PWR_LED
3	FP_PWR_LED

Speaker Connector Pin Definitions	
Pin#	Signal
4	P5V
5	Key
6	R_SPKPIN_N
7	R_SPKPIN

## Overheat/Fan Fail LED Header

The JOH1 header is used to connect an LED indicator to provide warnings of chassis overheating and fan failure. This LED will blink when a fan failure occurs. Refer to the tables below for pin definitions.

Overheat LED header Status	
State	Definition
Solid	Overheat
Blinking	Fan Fail

Overheat LED Pin Definitions	
Pin#	Signal
1	Pull high to +3.3V power through 330-ohm resistor
2	OH Active

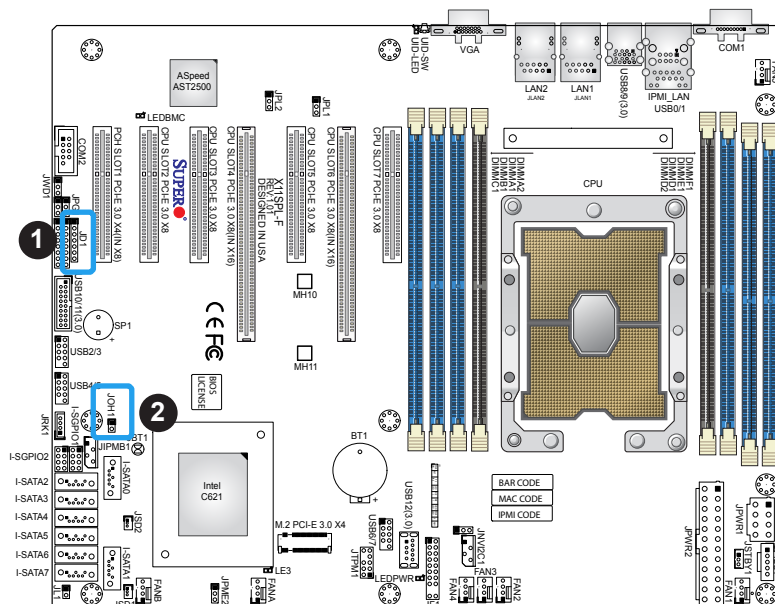

1. Power LED/Speaker Header
2. Overheat/Fan Fail LED Header

## SATA Ports

The X11SPL-F has eight SATA 3.0 ports (I-SATA0 ~ I-SATA7) supported by the Intel PCH C621 chipset. These SATA ports support RAID 0, 1, 5, and 10. SATA ports provide serial-link signal connections, which are faster than the connections of Parallel ATA. Refer to the table below for pin definitions.

**Note:** Supermicro SuperDOMs are yellow SATADOM connectors with power pins built in and do not require separate external power cables. These connectors are backwards compatible with non-Supermicro SATADOMs that require an external power supply.

SATA 3.0 Port Pin Definitions	
Pin#	Signal
1	Ground
2	SATA_TXP
3	SATA_TXN
4	Ground
5	SATA_RXN
6	SATA_RXP
7	Ground

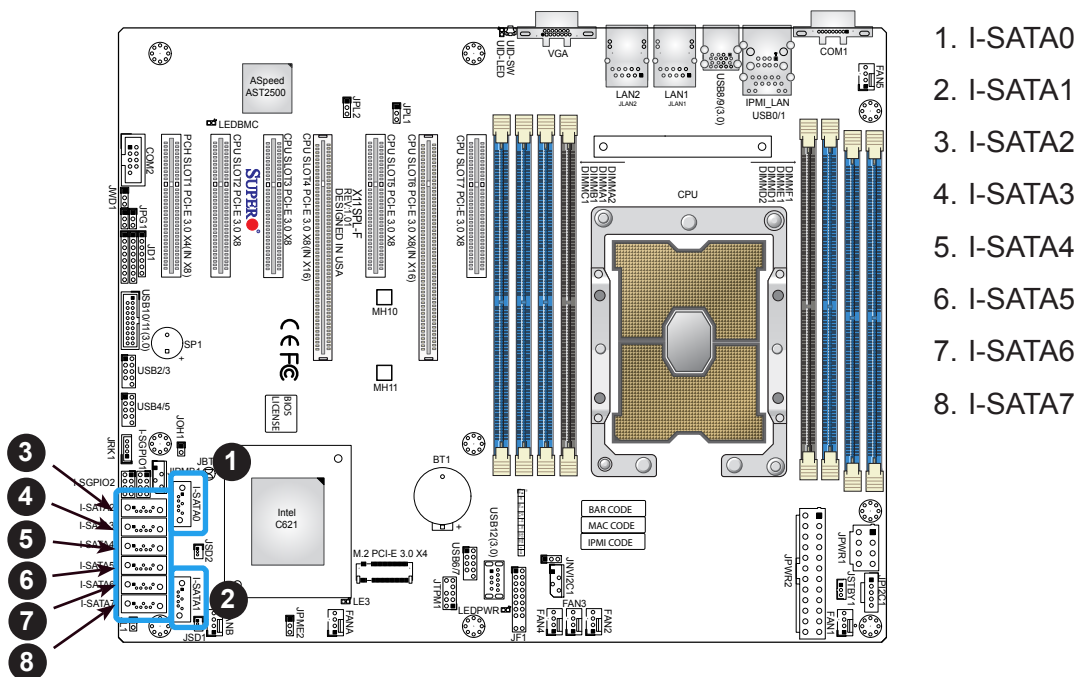

1. I-SATA0
2. I-SATA1
3. I-SATA2
4. I-SATA3
5. I-SATA4
6. I-SATA5
7. I-SATA6
8. I-SATA7



## 2.8 Jumper Settings

### How Jumpers Work

To modify the operation of the motherboard, jumpers can be used to choose between optional settings. Jumpers create shorts between two pins to change the function of the connector. Pin 1 is identified with a square solder pad on the printed circuit board. See the diagram below for an example of jumping pins 1 and 2. Refer to the motherboard layout page for jumper locations.

 **Note:** On two-pin jumpers, "Closed" means the jumper is on and "Open" means the jumper is off the pins.

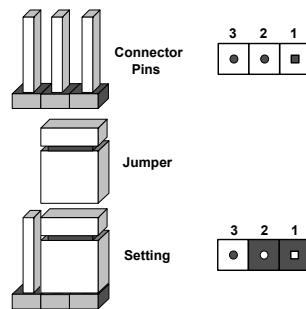

### CMOS Clear

JBT1 is used to clear CMOS, which will also clear any passwords. Instead of pins, this jumper consists of contact pads to prevent accidentally clearing the contents of CMOS.

#### **To Clear CMOS**

1. First power down the system and unplug the power cord(s).
2. Remove the cover of the chassis to access the motherboard.
3. Remove the onboard battery from the motherboard.
4. Short the CMOS pads with a metal object such as a small screwdriver for at least four seconds.
5. Remove the screwdriver (or shorting device).
6. Replace the cover, reconnect the power cord(s), and power on the system.

 **Note:** Clearing CMOS will also clear all passwords.

Do not use the PW\_ON connector to clear CMOS.



JBT1 contact pads

## Watchdog

Watchdog (JWD1) is a system monitor that can reboot the system when a software application hangs. Close pins 1-2 to reset the system if an application hangs. Close pins 2-3 to generate a non-maskable interrupt (NMI) signal for the application that hangs. Refer to the table below for jumper settings. The Watchdog must also be enabled in the BIOS.

Watchdog Jumper Settings	
Jumper Setting	Definition
Pins 1-2	Reset
Pins 2-3	NMI
Open	Disabled

## VGA Enable/Disable

Jumper JPG1 allows the user to enable the onboard VGA connector. The default setting is pins 1-2 to enable the connection. Refer to the table below for jumper settings.

VGA Enable/Disable Jumper Settings	
Jumper Setting	Definition
Pins 1-2	Enabled
Pins 2-3	Disabled

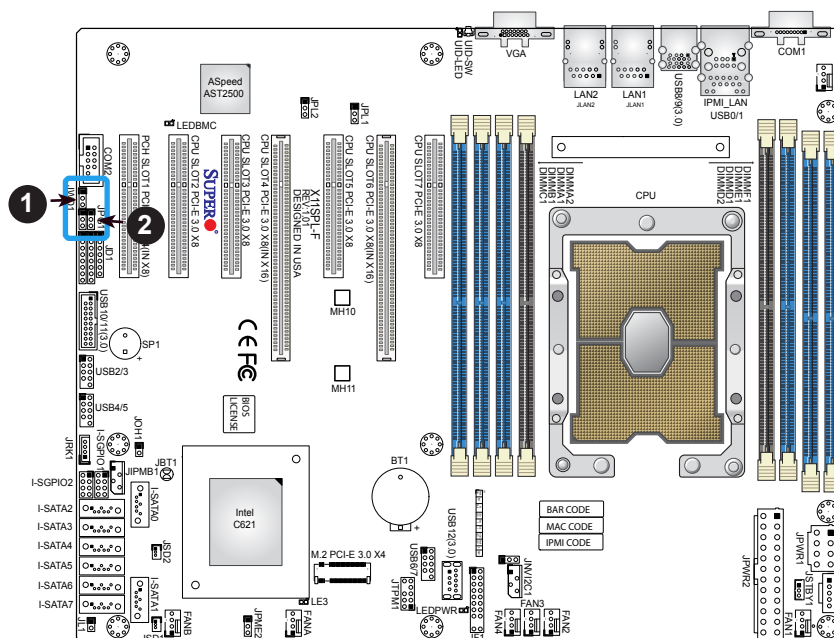

1. Watchdog
2. VGA Enable/Disable

### ME Manufacturing Mode

Close pins 2-3 of jumper JPME2 to bypass SPI flash security and force the system to operate in the manufacturing mode, which will allow the user to flash the system firmware from a host server for system setting modifications. Refer to the table below for jumper settings. The default setting is Normal.

Manufacturing Mode Jumper Settings	
Jumper Setting	Definition
Pins 1-2	Normal
Pins 2-3	Manufacturing Mode

### LAN1/LAN2 Enable/Disable

Jumpers JPL1 and JPL2 enables or disables LAN ports 1 and 2 on the motherboard. See the table below for jumper settings. The default setting is enabled.

LAN Enable Jumper Settings	
Jumper Setting	Definition
Pins 1-2	Enabled (default)
Pins 2-3	Disabled

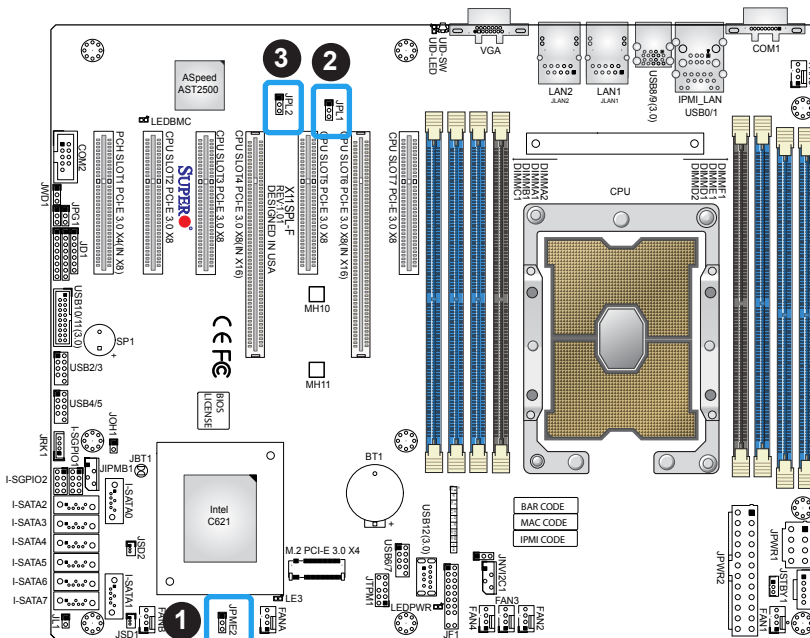

1. Manufacturing Mode
2. LAN1 Enable
3. LAN2 Enable

## 2.9 LED Indicators

### LAN LEDs

Two LAN ports (LAN1, LAN2) are located on the I/O back panel of the motherboard. Each Ethernet LAN port has two LEDs. The green LED indicates activity, while the other Link LED may be green, amber, or off to indicate the speed of the connection. Refer to the tables below for more information.

LAN1/2 Activity LED (Right) LED State		
Color	Status	Definition
Green	Flashing	Active

LAN1/2 Link LED (Left) LED State	
LED Color	Definition
Green	100 Mbps
Yellow/Amber	1 Gbps

### M.2 LED

An M.2 LED is located at LE3 on the motherboard. When LE3 is blinking, M.2 functions normally. Refer to the table below for more information.

M.2 LED State	
LED Color	Definition
Green: Blinking	Device Working

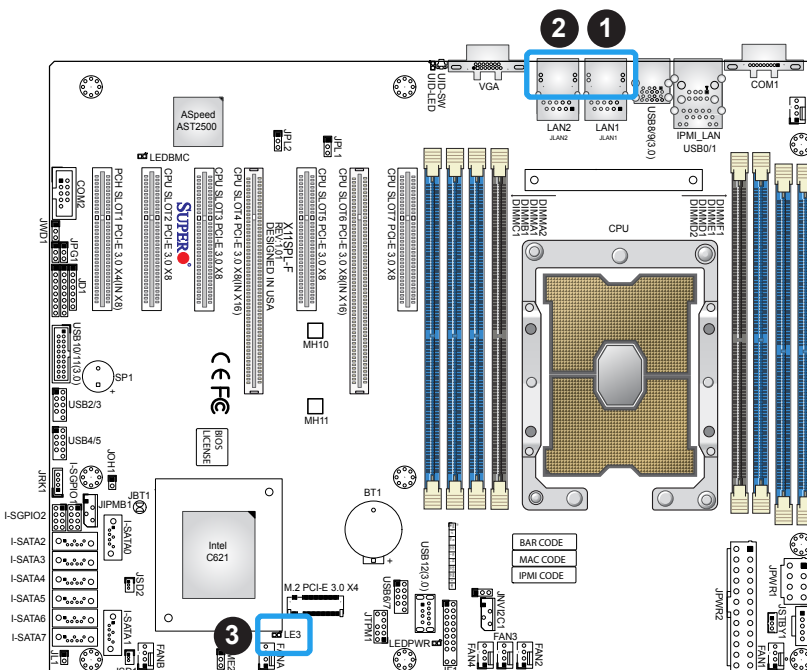

1. LAN1 LED
2. LAN2 LED
3. M.2 LED

### IPMI LAN LEDs

In addition to LAN1 and LAN2, an IPMI LAN is also located on the I/O back panel. The amber LED on the right indicates activity, while the green LED on the left indicates the speed of the connection. Refer to the table below for more information.

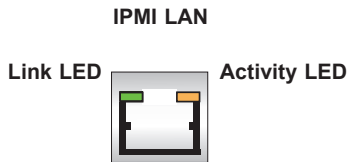

IPMI LAN LEDs		
	Color/State	Definition
Link (left)	Green: Solid	100 Mbps
	Amber: Solid	1Gbps
Activity (Right)	Amber: Blinking	Active

### BMC Heartbeat LED

A BMC Heartbeat LED is located at LEDBMC on the motherboard. When LEDBMC is blinking, the BMC is functioning normally. Refer to the table below for more information.

BMC Heartbeat LED Indicator	
LED Color	Definition
Green: Blinking	BMC Normal

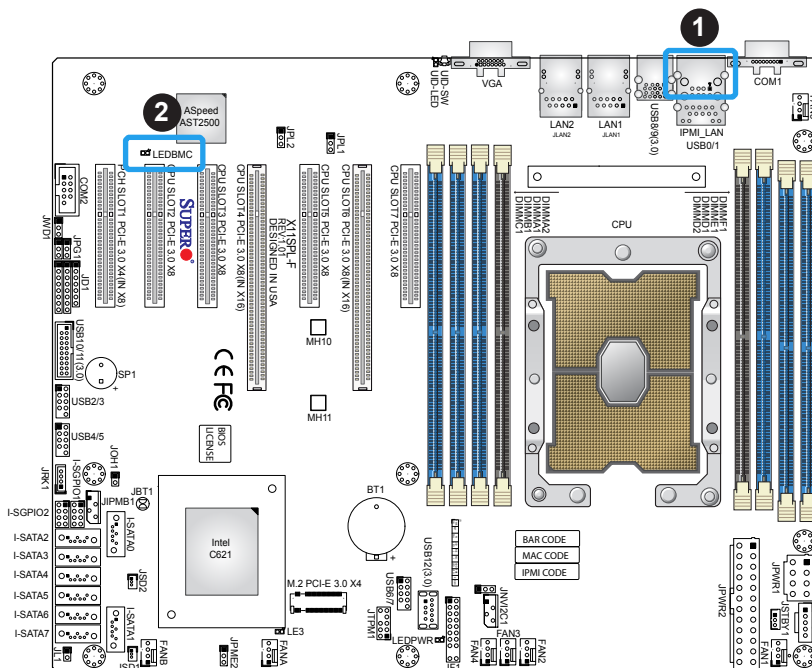

1. Dedicated IPMI LAN LED
2. BMC Heartbeat LED

## Onboard Power LED

The Onboard Power LED is located at LEDPWR on the motherboard. When this LED is on, the system is on. Be sure to turn off the system and unplug the power cord before removing or installing components. Refer to the table below for more information.

Onboard Power LED Indicator	
LED Color	Definition
Off	System Off (power cable not connected)
Green	System On

## Unit ID LED

A rear UID LED indicator (UID-LED) is located near the UID switch on the I/O back panel. This UID indicator provides easy identification of a system unit that may need service.

UID LED LED Indicator	
LED Color	Definition
Blue: On	Unit Identified

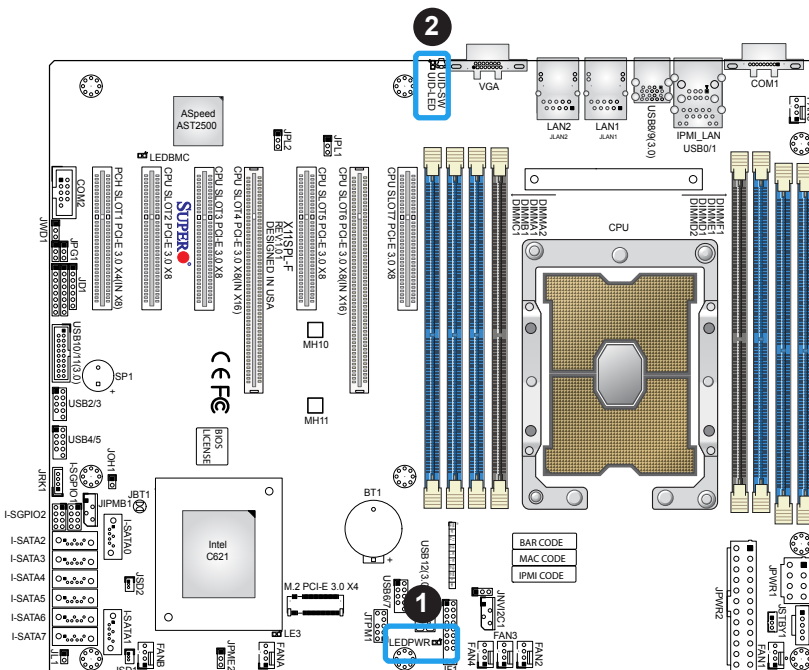

1. Onboard Power LED
2. UID LED

## Chapter 3

# Troubleshooting

### 3.1 Troubleshooting Procedures

Use the following procedures to troubleshoot your system. If you have followed all of the procedures below and still need assistance, refer to the 'Technical Support Procedures' and/or 'Returning Merchandise for Service' section(s) in this chapter. Always disconnect the AC power cord before adding, changing or installing any non hot-swap hardware components.

#### **Before Power On**

1. Make sure that there are no short circuits between the motherboard and chassis.
2. Disconnect all ribbon/wire cables from the motherboard, including those for the keyboard and mouse.
3. Remove all add-on cards.
4. Install the CPU (making sure it is fully seated) and connect the front panel connectors to the motherboard.

#### **No Power**

1. Make sure that there are no short circuits between the motherboard and the chassis.
2. Make sure that the ATX power connectors are properly connected.
3. Check that the 115V/230V switch, if available, on the power supply is properly set.
4. Turn the power switch on and off to test the system, if applicable.
5. The battery on your motherboard may be old. Check to verify that it still supplies ~3VDC. If it does not, replace it with a new one.

## No Video

1. If the power is on, but you have no video, remove all add-on cards and cables.
2. Use the speaker to determine if any beep codes are present. Refer to Appendix A for details on beep codes.
3. Remove all memory modules and turn on the system (if the alarm is on, check the specs of memory modules, reset the memory or try a different one).

## System Boot Failure

If the system does not display POST (Power-On-Self-Test) or does not respond after the power is turned on, check the following:

1. Check for any error beep from the motherboard speaker.
  - If there is no error beep, try to turn on the system without DIMM modules installed. If there is still no error beep, replace the motherboard.
  - If there are error beeps, clear the CMOS settings by unplugging the power cord and contacting both pads on the CMOS clear jumper (JBT1). Refer to Section 2-8 in Chapter 2.
2. Remove all components from the motherboard, especially the DIMM modules. Make sure that system power is on and that memory error beeps are activated.
3. Turn on the system with only one DIMM module installed. If the system boots, check for bad DIMM modules or slots by following the Memory Errors Troubleshooting procedure in this chapter.

## Memory Errors

When a no-memory beep code is issued by the system, check the following:

1. Make sure that the memory modules are compatible with the system and are properly installed. See Chapter 2 for installation instructions. (For memory compatibility, refer to the "Tested Memory List" link on the motherboard's product page to see a list of supported memory.)
2. Check if different speeds of DIMMs have been installed. It is strongly recommended that you use the same RAM type and speed for all DIMMs in the system.
3. Make sure that you are using the correct type of ECC DDR4 modules recommended by the manufacturer.
4. Check for bad DIMM modules or slots by swapping a single module among all memory slots and check the results.

## Losing the System's Setup Configuration

1. Make sure that you are using a high-quality power supply. A poor-quality power supply may cause the system to lose the CMOS setup information. Refer to Chapter 2 for details on recommended power supplies.
2. The battery on your motherboard may be old. Check to verify that it still supplies ~3VDC. If it does not, replace it with a new one.
3. If the above steps do not fix the setup configuration problem, contact your vendor for repairs.

## When the System Becomes Unstable

### ***A. If the system becomes unstable during or after OS installation, check the following:***

1. CPU/BIOS support: Make sure that your CPU is supported and that you have the latest BIOS installed in your system.
2. Memory support: Make sure that the memory modules are supported by testing the modules using memtest86 or a similar utility.



**Note:** Click on the "Tested Memory List" link on the motherboard's product page to see a list of supported memory.

3. HDD support: Make sure that all hard disk drives (HDDs) work properly. Replace the bad HDDs with good ones.
4. System cooling: Check the system cooling to make sure that all heatsink fans and CPU/system fans, etc., work properly. Check the hardware monitoring settings in the IPMI to make sure that the CPU and system temperatures are within the normal range. Also check the front panel Overheat LED and make sure that it is not on.
5. Adequate power supply: Make sure that the power supply provides adequate power to the system. Make sure that all power connectors are connected. Please refer to our website for more information on the minimum power requirements.
6. Proper software support: Make sure that the correct drivers are used.

### ***B. If the system becomes unstable before or during OS installation, check the following:***

1. Source of installation: Make sure that the devices used for installation are working properly, including boot devices such as CD/DVD and CD/DVD-ROM.
2. Cable connection: Check to make sure that all cables are connected and working properly.

3. Using the minimum configuration for troubleshooting: Remove all unnecessary components (starting with add-on cards first), and use the minimum configuration (but with the CPU and a memory module installed) to identify the trouble areas. Refer to the steps listed in Section A above for proper troubleshooting procedures.
4. Identifying bad components by isolating them: If necessary, remove a component in question from the chassis, and test it in isolation to make sure that it works properly. Replace a bad component with a good one.
5. Check and change one component at a time instead of changing several items at the same time. This will help isolate and identify the problem.
6. To find out if a component is good, swap this component with a new one to see if the system will work properly. If so, then the old component is bad. You can also install the component in question in another system. If the new system works, the component is good and the old system has problems.

## 3.2 Technical Support Procedures

Before contacting Technical Support, please take the following steps. Also, please note that as a motherboard manufacturer, Supermicro also sells motherboards through its channels, so it is best to first check with your distributor or reseller for troubleshooting services. They should know of any possible problems with the specific system configuration that was sold to you.

1. Please go through the Troubleshooting Procedures and Frequently Asked Questions (FAQ) sections in this chapter or see the FAQs on our website (<http://www.supermicro.com/FAQ/index.php>) before contacting Technical Support.
2. BIOS upgrades can be downloaded from our website ([http://www.supermicro.com/ResourceApps/BIOS\\_IPMI\\_Intel.html](http://www.supermicro.com/ResourceApps/BIOS_IPMI_Intel.html)).
3. If you still cannot resolve the problem, include the following information when contacting Supermicro for technical support:
  - Motherboard model and PCB revision number
  - BIOS release date/version (This can be seen on the initial display when your system first boots up.)
  - System configuration
4. An example of a Technical Support form is on our website at <http://www.supermicro.com/RmaForm/>.
  - Distributors: For immediate assistance, please have your account number ready when placing a call to our Technical Support department. We can be reached by email at [support@supermicro.com](mailto:support@supermicro.com).

### 3.3 Frequently Asked Questions

**Question: What type of memory does my motherboard support?**

**Answer:** The motherboard supports DDR4 ECC RDIMM, LRDIMM, or 3DS LRDIMM modules. To enhance memory performance, do not mix memory modules of different speeds and sizes. Please follow all memory installation instructions given on Section 2-4 in Chapter 2.

**Question: How do I update my BIOS?**

**Answer:** It is recommended that you do not upgrade your BIOS if you are not experiencing any problems with your system. Updated BIOS files are located on our website at [http://www.supermicro.com/ResourceApps/BIOS\\_IPMI\\_Intel.html](http://www.supermicro.com/ResourceApps/BIOS_IPMI_Intel.html). Please check our BIOS warning message and the information on how to update your BIOS on our website. Select your motherboard model and download the BIOS file to your computer. Also, check the current BIOS revision to make sure that it is newer than your BIOS before downloading. Please unzip the BIOS file onto a bootable USB device. Run the batch file using the format FLASH.BAT filename.rom from your bootable USB device to flash the BIOS. Then, your system will automatically reboot.

**Warning:** Do not shut down or reset the system while updating the BIOS to prevent possible system boot failure!



**Note:** The SPI BIOS chip used on this motherboard cannot be removed. Send your motherboard back to our RMA Department at Supermicro for repair. For BIOS Recovery instructions, please refer to the AMI BIOS Recovery Instructions posted at <http://www.supermicro.com/support/manuals/>.

## 3.4 Battery Removal and Installation

### Battery Removal

To remove the onboard battery, follow the steps below:

1. Power off your system and unplug your power cable.
2. Using a tool such as a pen or a small screwdriver, push the battery lock outwards to unlock it. Once unlocked, the battery will pop out from the holder.
3. Remove the battery.

### Proper Battery Disposal

**Warning:** Please handle used batteries carefully. Do not damage the battery in any way; a damaged battery may release hazardous materials into the environment. Do not discard a used battery in the garbage or a public landfill. Please comply with the regulations set up by your local hazardous waste management agency to dispose of your used battery properly.

### Battery Installation

1. To install an onboard battery, follow steps 1 and 2 above and continue below:
2. Identify the battery's polarity. The positive (+) side should be facing up.
3. Insert the battery into the battery holder and push it down until you hear a click to ensure that the battery is securely locked.

**Warning:** When replacing a battery, be sure to only replace it with the same type.

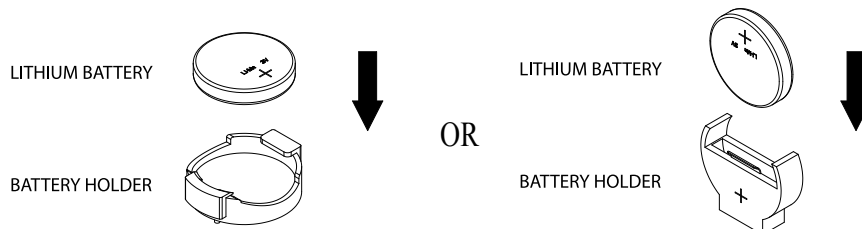

### 3.5 Returning Merchandise for Service

A receipt or copy of your invoice marked with the date of purchase is required before any warranty service will be rendered. You can obtain service by calling your vendor for a Returned Merchandise Authorization (RMA) number. When returning the motherboard to the manufacturer, the RMA number should be prominently displayed on the outside of the shipping carton, and the shipping package is mailed prepaid or hand-carried. Shipping and handling charges will be applied for all orders that must be mailed when service is complete. For faster service, you can also request a RMA authorization online (<http://www.supermicro.com/RmaForm/>).

This warranty only covers normal consumer use and does not cover damages incurred in shipping or from failure due to the alternation, misuse, abuse or improper maintenance of products.

During the warranty period, contact your distributor first for any product problems.

## Chapter 4

### BIOS

#### 4.1 Introduction

This chapter describes the AMIBIOS™ Setup utility for the motherboard. The BIOS is stored on a chip and can be easily upgraded using a flash program.



**Note:** Due to periodic changes to the BIOS, some settings may have been added or deleted and might not yet be recorded in this manual. Please refer to the Manual Download area of our website for any changes to the BIOS that may not be reflected in this manual.

#### Starting the Setup Utility

To enter the BIOS Setup Utility, hit the <Delete> key while the system is booting-up. (In most cases, the <Delete> key is used to invoke the BIOS setup screen. There are a few cases when other keys are used, such as <F1>, <F2>, etc.) Each main BIOS menu option is described in this manual.

The Main BIOS screen has two main frames. The left frame displays all the options that can be configured. "Grayed-out" options cannot be configured. The right frame displays the key legend. Above the key legend is an area reserved for a text message. When an option is selected in the left frame, it is highlighted in white. Often a text message will accompany it. (Note that the BIOS has default text messages built in. We retain the option to include, omit, or change any of these text messages.) Settings printed in **Bold** are the default values.

A " ►" indicates a submenu. Highlighting such an item and pressing the <Enter> key will open the list of settings within that submenu.

The BIOS setup utility uses a key-based navigation system called hot keys. Most of these hot keys (<F1>, <F2>, <F3>, <Enter>, <ESC>, <Arrow> keys, etc.) can be used at any time during the setup navigation process.

## 4.2 Main Setup

When you first enter the AMI BIOS setup utility, you will enter the Main setup screen. You can always return to the Main setup screen by selecting the Main tab on the top of the screen. The Main BIOS setup screen is shown below and the following items will be displayed:

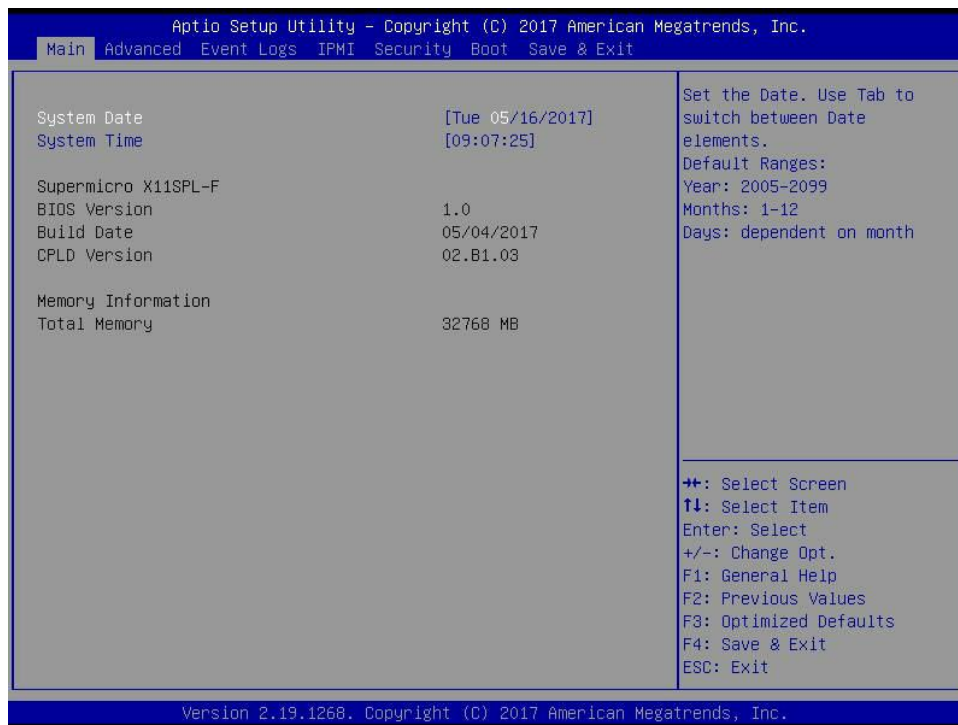

### System Date/System Time

Use this option to change the system date and time. Highlight *System Date* or *System Time* using the arrow keys. Enter new values using the keyboard. Press the <Tab> key or the arrow keys to move between fields. The date must be entered in MM/DD/YYYY format. The time is entered in HH:MM:SS format.

 **Note:** The time is in the 24-hour format. For example, 5:30 P.M. appears as 17:30:00. The date's default value is the BIOS build date after RTC reset.

### Supermicro X11SPL-F

#### BIOS Version

This item displays the version of the BIOS ROM used in the system.

#### Build Date

This item displays the date when the version of the BIOS ROM used in the system was built.

**CPLD Version**

This item displays the Complex Programmable Logic Device version.

**Memory Information**

**Total Memory**

This item displays the total size of memory available in the system.

## 4.3 Advanced Setup Configurations

Use the arrow keys to select the Advanced menu and press <Enter> to access the submenu items:

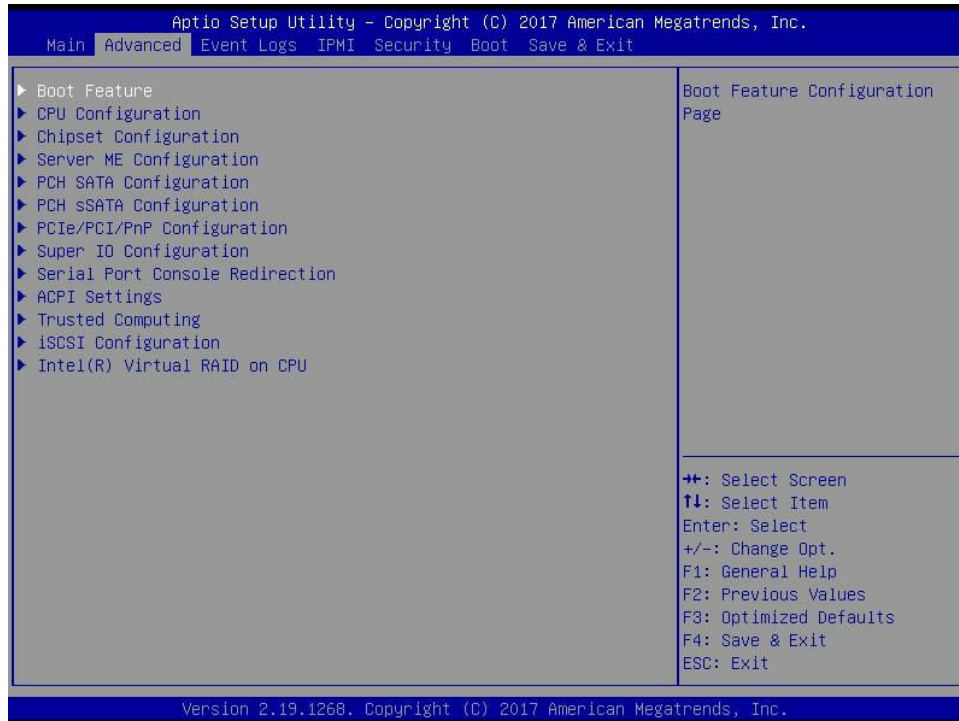

**Warning:** Take caution when changing the Advanced settings. An incorrect value, a very high DRAM frequency, or an incorrect DRAM timing setting may make the system unstable. When this occurs, revert to default manufacturer settings.

### ► Boot Feature

#### Quiet Boot

Use this feature to select the screen display between the POST messages and the OEM logo upon bootup. Select Disabled to display the POST messages. Select Enabled to display the OEM logo instead of the normal POST messages. The options are Disabled and **Enabled**.

#### Option ROM Messages

Use this feature to set the display mode for the Option ROM. Select Keep Current to display the current AddOn ROM setting. Select Force BIOS to use the Option ROM display set by the system BIOS. The options are **Force BIOS** and Keep Current.

#### Startup NumLock State

Use this feature to set the Power-on state for the <Numlock> key. The options are **On** and Off.

### **Wait For "F1" If Error**

Use this feature to force the system to wait until the "F1" key is pressed if an error occurs. The options are Disabled and **Enabled**.

### **INT19 (Interrupt 19) Trap Response**

Interrupt 19 is the software interrupt that handles the boot disk function. When this item is set to Immediate, the ROM BIOS of the host adaptors will "capture" Interrupt 19 at bootup immediately and allow the drives that are attached to these host adaptors to function as bootable disks. If this item is set to Postponed, the ROM BIOS of the host adaptors will not capture Interrupt 19 immediately and allow the drives attached to these adaptors to function as bootable devices at bootup. The options are **Immediate** and Postponed.

### **Re-try Boot**

If this item is enabled, the BIOS will automatically reboot the system from a specified boot device after its initial boot failure. The options are **Disabled**, Legacy Boot, and EFI Boot.

### **Install Windows 7 USB Support**

Enable this feature to use the USB keyboard and mouse during the Windows 7 installation since the native XHCI driver support is unavailable. Use a SATA optical drive as a USB drive, and USB CD/DVD drives are not supported. Disable this feature after the XHCI driver has been installed in Windows. The options are **Disabled** and Enabled.

### **Port 61h Bit-4 Emulation**

Select Enabled to enable the emulation of Port 61h bit-4 toggling in SMM (System Management Mode). The options are **Disabled** and Enabled.

### **Power Configuration**

#### **Watch Dog Function**

If enabled, the Watch Dog Timer will allow the system to reset or generate NMI based on jumper settings when it is expired for more than five minutes. The options are **Disabled** and Enabled.

#### **Restore on AC Power Loss**

Use this feature to set the power state after a power outage. Select Stay Off for the system power to remain off after a power loss. Select Power On for the system power to be turned on after a power loss. Select Last State to allow the system to resume its last power state before a power loss. The options are Stay Off, Power On, and **Last State**.

### **Power Button Function**

This feature controls how the system shuts down when the power button is pressed. Select 4 Seconds Override for the user to power off the system after pressing and holding the power button for 4 seconds or longer. Select Instant Off to instantly power off the system as soon as the user presses the power button. The options are **Instant Off** and 4 Seconds Override.

### **Throttle on Power Fail**

Use this feature to decrease system power by throttling CPU frequency when one power supply has failed. The options are **Disabled** and Enabled.

## **►CPU Configuration**

The following CPU information will display:

- Processor BSP Revision
- Processor Socket
- Processor ID
- Processor Frequency
- Processor Max Ratio
- Processor Min Ratio
- Microcode Revision
- L1 Cache RAM
- L2 Cache RAM
- L3 Cache RAM
- Processor 0 Version

### **Hyper-Threading (ALL) (Available when supported by the CPU)**

Select Enable to support Intel Hyper-threading Technology to enhance CPU performance. The options are Disable and **Enable**.

### **Execute Disable Bit (Available if supported by the OS & the CPU)**

Select Enable to enable the Execute-Disable Bit, which will allow the processor to designate areas in the system memory where an application code can execute and where it cannot, thus preventing a worm or a virus from flooding illegal codes to overwhelm the processor or damage the system during an attack. The options are Disable and **Enable**. (Refer to the Intel® and Microsoft® websites for more information.)

### **Intel Virtualization Technology**

Use feature to enable the Vanderpool Technology. This technology allows the system to run several operating systems simultaneously. The options are Disable and **Enable**.

### **PPIN Control**

Select Unlock/Enable to use the Protected Processor Inventory Number (PPIN) in the system. The options are Unlock/Disable and **Unlock/Enable**.

### **Hardware Prefetcher (Available when supported by the CPU)**

If set to Enable, the hardware prefetcher will prefetch streams of data and instructions from the main memory to the L2 cache to improve CPU performance. The options are Disable and **Enable**.

### **Adjacent Cache Prefetch (Available when supported by the CPU)**

The CPU prefetches the cache line for 64 bytes if this feature is set to Disabled. The CPU prefetches both cache lines for 128 bytes as comprised if this feature is set to Enable. The options are **Enable** and Disable.

### **DCU Streamer Prefetcher (Available when supported by the CPU)**

Select Enable to enable the DCU (Data Cache Unit) Streamer Prefetcher which will stream and prefetch data and send it to the Level 1 data cache to improve data processing and system performance. The options are Disable and **Enable**.

### **DCU IP Prefetcher (Available when supported by the CPU)**

Select Enable for DCU (Data Cache Unit) IP Prefetcher support, which will prefetch IP addresses to improve network connectivity and system performance. The options are **Enable** and Disable.

### **LLC Prefetch**

If set to Enable, the hardware prefetcher will prefetch streams of data and instructions from the main memory to the L3 cache to improve CPU performance. The options are **Disable** and Enable.

### **Extended APIC**

Select Enable to activate APIC (Advanced Programmable Interrupt Controller) support. The options are **Disable** and Enable.

## AES-NI

Select Enable to use the Intel Advanced Encryption Standard (AES) New Instructions (NI) to ensure data security. The options are Disable and **Enable**.

## ► Advanced Power Management Configuration

### ► CPU P State Control

This feature allows the user to configure the following CPU power settings:

#### SpeedStep (Pstates)

Intel SpeedStep Technology allows the system to automatically adjust processor voltage and core frequency to reduce power consumption and heat dissipation. The options are Disable and **Enable**.

#### EIST PSD Funtion

This feature allows the user to choose between Hardware and Software to control the processor's frequency and performance (P-state). In HW\_ALL mode, the processor hardware is responsible for coordinating the P-state, and the OS is responsible for keeping the P-state request up to date on all Logical Processors. In SW\_ALL mode, the OS Power Manager is responsible for coordinating the P-state, and must initiate the transition on all Logical Processors. In SW\_ANY mode, the OS Power Manager is responsible for coordinating the P-state and may initiate the transition on any Logical Processors. The options are **HW\_ALL**, SW\_ALL, and SW\_ANY.

#### Turbo Mode

This feature will enable dynamic control of the processor, allowing it to run above stock frequency. The options are Disable and **Enable**.

## ► Hardware PM State Control

### Hardware P-States

This setting allows the user to select between OS and hardware-controlled P-states. Selecting Native Mode allows the OS to choose a P-state. Selecting Out of Band Mode allows the hardware to autonomously choose a P-state without OS guidance. Selecting Native Mode with No Legacy Support functions as Native Mode with no support for older hardware. The options are **Disable**, Native Mode, Out of Band Mode, and Native Mode with No Legacy Support.

## ▶ CPU C State Control

### Autonomous Core C-State

Enabling this setting allows the hardware to autonomously choose to enter a C-state based on power consumption and clock speed. The options are **Disable** and **Enable**.

### CPU C6 Report

Select **Enable** to allow the BIOS to report the CPU C6 State (ACPI C3) to the operating system. During the CPU C6 State, the power to all cache is turned off. The options are **Disable**, **Enable**, and **Auto**.

### Enhanced Halt State (C1E)

Select **Enable** to use Enhanced Halt State technology, which will significantly reduce the CPU's power consumption by reducing its clock cycle and voltage during a Halt-state. The options are **Disable** and **Enable**.

## ▶ Package C State Control

### Package C State

This feature allows the user to set the limit on the C State package register. The options are **C0/C1 State**, **C2 State**, **C6 (Non Retention) State**, **C6 (Retention) State**, **No Limit**, and **Auto**.

## ▶ CPU T State Control

### Software Controlled T-States

Use this feature to enable Software Controlled T-States. The options are **Disable** and **Enable**.

## ▶ Chipset Configuration

**Warning:** Setting the wrong values in the following features may cause the system to malfunction.

### ▶ North Bridge

This feature allows the user to configure the following North Bridge settings.

### ► UPI Configuration

The following UPI information will display:

- Number of CPU
- Number of IIO
- Current UPI Link Speed
- Current UPI Link Frequency
- UPI Global MMIO Low Base / Limit
- UPI Global MMIO High Base / Limit
- UPI Pci-e Configuration Base / Size

### Degrade Precedence

Use this feature to set degrade precedence when system settings are in conflict. Select Topology Precedence to degrade Features. Select Feature Precedence to degrade Topology. The options are **Topology Precedence** and Feature Precedence.

### Link L0p Enable

Select Enable for the QPI to enter the L0p state for power saving. The options are Disable, Enable, and **Auto**.

### Link L1 Enable

Select Enable for the QPI to enter the L1 state for power saving. The options are Disable, Enable, and **Auto**.

### IO Directory Cache (IODC)

IO Directory Cache is an 8-entry cache that stores the directory state of remote IIO writes and memory lookups, and saves directory updates. Use this feature to lower cache to cache (C2C) transfer latencies. The options are Disable, **Auto**, Enable for Remote InvltoM Hybrid Push, InvltoM AllocFlow, Enable for Remote InvltoM Hybrid AllocNonAlloc, and Enable for Remote InvltoM and Remote WViLF.

### Isoc Mode

Isochronous (Isoc) mode allows time-sensitive processes to be given priority. The options are Disable, Enable, and **Auto**.

## ► Memory Configuration

### Enforce POR

Select POR (Plan of Record) to enforce POR restrictions on DDR4 frequency and voltage programming. The options are **POR** and Disable.

### Memory Frequency

Use this feature to set the maximum memory frequency for onboard memory modules. The options are **Auto**, 1866, 2000, 2133, 2200, 2400, 2600, and 2666.

### Data Scrambling for NVDIMM

Use this feature to enable or disable data scrambling for non-volatile DIMM (NVDIMM) memory. The options are **Auto**, Disable, and Enable.

### Data Scrambling for DDR4

Use this feature to enable or disable data scrambling for DDR4 memory. The options are **Auto**, Disable, and Enable.

### tCCD\_L Relaxation

Select Enable to get TCDD settings from SPD (Serial Presence Detect) and implement into memory RC code to improve system reliability. Select Disable for TCCD to follow Intel POR. The options are **Disable** and Enable.

### Enable ADR

Select Enable for ADR (Automatic Diagnostic Repository) support to enhance memory performance. The options are **Disable** and Enable.

### 2X REFRESH

Use this feature to select the memory controller refresh rate to 2x refresh mode. The options are **Auto** and Enable.

## ► Memory Topology

This item displays the information of onboard memory modules as detected by the BIOS.

## ► Memory RAS Configuration

### Static Virtual Lockstep Mode

Select Enable to run the system's memory channels in lockstep mode to minimize memory access latency. The options are **Disable** and Enable.

**Mirror Mode**

This feature allows memory to be mirrored between two channels, providing 100% redundancy. The options are **Disable**, Mirror Mode 1LM, and Mirror Mode 2LM.

**UEFI ARM Mirror**

Select Enable to support the UEFI-based address range mirroring with setup option. The options are **Disable** and Enable.

**Memory Rank Sparing**

Select Enable to enable memory-sparing support for memory ranks to improve memory performance. The options are **Disable** and Enable.

**Correctable Error Threshold**

Use this item to specify the threshold value for correctable memory-error logging, which sets a limit on the maximum number of events that can be logged in the memory error log at a given time. The default setting is **100**.

**SDDC Plus One**

Single device data correction +1 (SDDC Plus One) organizes data in a single bundle (x4/x8 DRAM). If any or all the bits become corrupted, corrections occur. The x4 condition is corrected on all cases. The x8 condition is corrected only if the system is in Lockstep Mode. The options are **Disable** and Enable.

**ADDDC Sparing**

Adaptive Double Device Data Correction (ADDDC) Sparing detects when the predetermined threshold for correctable errors is reached, copying the contents of the failing DIMM to spare memory. The failing DIMM or memory rank will then be disabled. The options are **Disable** and Enable.

**Patrol Scrub**

Patrol Scrubbing is a process that allows the CPU to correct correctable memory errors detected on a memory module and send the correction to the requestor (the original source). When this item is set to Enable, the IO hub will read and write back one cache line every 16K cycles if there is no delay caused by internal processing. By using this method, roughly 64 GB of memory behind the IO hub will be scrubbed every day. The options are Disable and **Enable**.

**Patrol Scrub Interval**

This feature allows you to decide how many hours the system should wait before the next complete patrol scrub is performed. Use the keyboard to enter a value from 0-24. The default setting is **24**.

## ► I/O Configuration

### EV DFX Features

When this feature is set to Enable, the EV\_DFX Lock Bits that are located on a processor will always remain clear during electric tuning. The options are **Disable** and **Enable**.

### ► CPU1 Configuration

#### IOU0 (I/O PCIe Br1)

This item configures the PCI-E port Bifurcation setting for a PCI-E port specified by the user. The options are x4x4x4x4, x4x4x8, x8x4x4, x8x8, x16, and **Auto**.

#### IOU1 (I/O PCIe Br2)

This item configures the PCI-E port Bifurcation setting for a PCI-E port specified by the user. The options are x4x4x4x4, x4x4x8, x8x4x4, x8x8, x16, and **Auto**.

#### IOU2 (I/O PCIe Br3)

This item configures the PCI-E port Bifurcation setting for a PCI-E port specified by the user. The options are x4x4x4x4, x4x4x8, x8x4x4, x8x8, x16, and **Auto**.

### ► CPU SLOT5 PCI-E 3.0 X8 / CPU SLOT4 PCI-E 3.0 X8 (IN X16) / CPU SLOT6 PCI-E 3.0 X8 (IN X16) / CPU SLOT7 PCI-E 3.0 X8 / CPU SLOT2 PCI-E 3.0 X8 / CPU SLOT3 PCI-E 3.0 X8

#### Link Speed

Use this item to select the link speed for the PCI-E port specified by the user. The options are **Auto**, Gen 1 (2.5 GT/s), Gen 2 (5 GT/s), and Gen 3 (8 GT/s).

The following information will also be displayed:

- PCI-E Port Link Status
- PCI-E Port Link Max
- PCI-E Port Link Speed

#### PCI-E Port Max Payload Size

Selecting **Auto** for this feature will enable the motherboard to automatically detect the maximum Transaction Layer Packet (TLP) size for the connected PCI-E device, allowing for maximum I/O efficiency. Selecting 128B or 256B will designate maximum packet size of 128 or 256. The options are 128B, 256B, and **Auto**.

## ► IOAT Configuration

### Disable TPH

Transparent Huge Pages (TPH) is a Linux memory management system that enables communication in larger blocks (pages). Enabling this feature will increase performance. The options are **No** and **Yes**.

### Prioritize TPH

Use this feature to enable Prioritize TPH support. The options are **Enable** and **Disable**.

### Relaxed Ordering

Select **Enable** to enable Relaxed Ordering support, which will allow certain transactions to violate the strict-ordering rules of PCI bus for a transaction to be completed prior to other transactions that have already been enqueued. The options are **Disable** and **Enable**.

## ► Intel® VT for Directed I/O (VT-d)

### Intel® VT for Directed I/O (VT-d)

Select **Enable** to use Intel Virtualization Technology for Direct I/O VT-d support by reporting the I/O device assignments to the VMM (Virtual Machine Monitor) through the DMAR ACPI tables. This feature offers fully-protected I/O resource sharing across Intel platforms, providing greater reliability, security and availability in networking and data-sharing. The options are **Enable** and **Disable**.

### Interrupt Remapping

Use this feature to enable Interrupt Remapping support, which detects and controls external interrupt requests. The options are **Enable** and **Disable**.

### PassThrough DMA

Use this feature to allow devices such as network cards to access the system memory without using a processor. Select **Enable** to use the Non-Isoch VT\_D Engine Pass Through Direct Memory Access (DMA) support. The options are **Enable** and **Disable**.

### ATS

Use this feature to enable Non-Isoch VT-d Engine Address Translation Services (ATS) support. ATS translates virtual addresses to physical addresses. The options are **Enable** and **Disable**.

### **Posted Interrupt**

Use this feature to enable VT\_D Posted Interrupt. The options are **Enable** and Disable.

### **Coherency Support (Non-Isoch)**

Use this feature to maintain setting coherency between processors or other devices. Select Enable for the Non-Isoch VT-d engine to pass through DMA to enhance system performance. The options are **Enable** and Disable.

## **► Intel® VMD Technology**

### **► Intel® VMD for Volume Management Device on CPU1**

#### **VMD Config for PStack0**

##### **Intel® VMD for Volume Management Device**

Select Enable to use the Intel Volume Management Device Technology for this stack. The options are **Disable** and Enable.

*\*If the item above is set to Enable, the following items will be displayed:*

##### **CPU SLOT5 PCI-E 3.0 X8 VMD / CPU SLOT4 PCI-E 3.0 X8 (IN X16) VMD (Available when the device is detected by the system)**

Select Enable to use the Intel Volume Management Device Technology for this specific root port. The options are **Disable** and Enable.

##### **Hot Plug Capable (Available when the device is detected by the system)**

Use this feature to enable hot plug support for PCIe root ports 1A~1D. The options are **Disable** and Enable.

#### **VMD Config for PStack1**

##### **Intel® VMD for Volume Management Device**

Select Enable to use the Intel Volume Management Device Technology for this stack. The options are **Disable** and Enable.

*\*If the item above is set to Enable, the following items will be displayed:*

##### **CPU SLOT6 PCI-E 3.0 X8 (IN X16) VMD / CPU SLOT7 PCI-E 3.0 X8 VMD (Available when the device is detected by the system)**

Select Enable to use the Intel Volume Management Device Technology for this specific root port. The options are **Disable** and Enable.

**Hot Plug Capable (Available when the device is detected by the system)**

Use this feature to enable hot plug support for PCIe root ports 2A~2D. The options are **Disable** and Enable.

**VMD Config for PStack2****Intel® VMD for Volume Management Device**

Select Enable to use the Intel Volume Management Device Technology for this stack. The options are **Disable** and Enable.

*\*If the item above is set to Enable, the following items will be displayed:*

**CPU SLOT2 PCI-E 3.0 X8 VMD / CPU SLOT3 PCI-E 3.0 X8 VMD (Available when the device is detected by the system)**

Select Enable to use the Intel Volume Management Device Technology for this specific root port. The options are **Disable** and Enable.

**Hot Plug Capable (Available when the device is detected by the system)**

Use this feature to enable hot plug support for PCIe root ports 3A~3D. The options are **Disable** and Enable.

**PCI-E Completion Timeout Disable**

Use this feature to enable PCI-E Completion Timeout support for electric tuning. The options are Yes, **No**, and Per-Port.

**► South Bridge**

The following USB information will display:

- USB Module Version
- USB Devices

**Legacy USB Support**

This feature enables support for USB 2.0 and older. The options are **Enabled**, Disabled, and Auto.

**XHCI Hand-off**

When this feature is disabled, the motherboard will not support USB 3.0. The options are Enabled and **Disabled**.

### **Port 60/64 Emulation**

This feature allows legacy I/O support for USB devices like mice and keyboards. The options are **Enabled** and Disabled.

## **► Server ME Configuration**

The following General ME Configuration will display:

- Oper. Firmware Version
- Backup Firmware Version
- Recovery Firmware Version
- ME Firmware Status #1
- ME Firmware Status #2
- Current State
- Error Code

## **► PCH SATA Configuration**

When this submenu is selected, the AMI BIOS automatically detects the presence of the SATA devices that are supported by the Intel PCH chip and displays the following items:

### **SATA Controller**

This item enables or disables the onboard SATA controller supported by the Intel PCH chip. The options are Disable and **Enable**.

### **Configure SATA as**

Select AHCI to configure a SATA drive specified by the user as an AHCI drive. Select RAID to configure a SATA drive specified by the user as a RAID drive. The options are **AHCI** and RAID.

### **SATA HDD Unlock**

This feature allows the user to remove any password-protected SATA disk drives. The options are **Enable** and Disable.

### **Aggressive Link Power Management**

When this item is set to Enable, the SATA AHCI controller manages the power usage of the SATA link. The controller will put the link in a low power mode during extended periods of I/O inactivity, and will return the link to an active state when I/O activity resumes. The options are **Disable** and Enable.

*\*If the item "Configure SATA as" above is set to RAID, the following items will display:*

#### **SATA RSTe Boot Info**

Select Enable to provide full int13h support for the devices attached to SATA controller. The options are Disable and **Enable**.

#### **SATA RAID Option ROM/UEFI Driver**

Select UEFI to load the EFI driver for system boot. Select Legacy to load a legacy driver for system boot. The options are Disable, EFI, and **Legacy**.

#### **SATA Port 0 ~ Port 7**

This item displays the information detected on the installed SATA drive on the particular SATA port.

- Model number of drive and capacity
- Software Preserve Support

#### **Port 0 ~ Port 7 Hot Plug**

Set this item to Enable for hot plug support, which will allow the user to replace a SATA drive without shutting down the system. The options are Disable and **Enable**.

#### **Port 0 ~ Port 7 Spin Up Device**

On an edge detect from 0 to 1, set this item to allow the PCH to initialize the device. The options are **Disable** and Enable.

#### **Port 0 ~ Port 7 SATA Device Type**

Use this item to specify if the SATA port specified by the user should be connected to a Solid State drive or a Hard Disk Drive. The options are **Hard Disk Drive** and Solid State Drive.

### **►PCH sSATA Configuration**

When this submenu is selected, the AMI BIOS automatically detects the presence of the SATA devices that are supported by the Intel PCH chip and displays the following items:

#### **sSATA Controller**

This item enables or disables the onboard sSATA controller supported by the Intel PCH chip. The options are **Enable** and Disable.

#### **Configure sSATA as**

Select AHCI to configure an sSATA drive specified by the user as an AHCI drive. Select RAID to configure an sSATA drive specified by the user as a RAID drive. The options are **AHCI** and RAID.

### **SATA HDD Unlock**

This feature allows the user to remove any password-protected SATA disk drives. The options are **Disable** and **Enable**.

### **Aggressive Link Power Management**

When this item is set to **Enable**, the SATA AHCI controller manages the power usage of the SATA link. The controller will put the link in a low power mode during extended periods of I/O inactivity, and will return the link to an active state when I/O activity resumes. The options are **Disable** and **Enable**.

***\*If the item "Configure sSATA as" above is set to RAID, the following items will display:***

#### **sSATA RSTe Boot Info**

Select **Enable** to provide full int13h support for the devices attached to sSATA controller. The options are **Disable** and **Enable**.

#### **sSATA RAID Option ROM/UEFI Driver**

Select **UEFI** to load the EFI driver for system boot. Select **Legacy** to load a legacy driver for system boot. The options are **Disable**, **EFI**, and **Legacy**.

#### **sSATA Port 2**

This item displays the information detected on the installed sSATA drive on the particular sSATA port.

- Model number of drive and capacity
- Software Preserve Support

### **Hot Plug**

Set this item to **Enable** for hot plug support, which will allow the user to replace a SATA drive without shutting down the system. The options are **Disable** and **Enable**.

### **Spin Up Device**

On an edge detect from 0 to 1, set this item to allow the PCH to initialize the device. The options are **Disable** and **Enable**.

### **sSATA Device Type**

Use this item to specify if the SATA port specified by the user should be connected to a Solid State drive or a Hard Disk Drive. The options are **Hard Disk Drive** and **Solid State Drive**.

## ► PCIe/PCI/PnP Configuration

The following information will display:

- PCI Bus Driver Version
- PCI Devices Common Settings:

### **Above 4G Decoding (Available if the system supports 64-bit PCI decoding)**

Select Enabled to decode a PCI device that supports 64-bit in the space above 4G Address. The options are Disabled and **Enabled**.

### **SR-IOV Support**

Use this feature to enable or disable Single Root IO Virtualization Support. The options are **Disabled** and Enabled.

### **MMIO High Base**

Use this item to select the base memory size according to memory-address mapping for the IO hub. The options are **56T**, 40T, 24T, 16T, 4T, and 1T.

### **MMIO High Granularity Size**

Use this item to select the high memory size according to memory-address mapping for the IO hub. The options are 1G, 4G, 16G, 64G, **256G**, and 1024G.

### **PCI PERR/SERR Support**

Select Enabled to allow a PCI device to generate a PERR/SERR number for a PCI Bus Signal Error Event. The options are Disabled and **Enabled**.

### **Maximum Read Request**

Use this item to select the Maximum Read Request size of the PCI-Express device, or select Auto to allow the System BIOS to determine the value. The options are **Auto**, 128 Bytes, 256 Bytes, 512 Bytes, 1024 Bytes, 2048 Bytes, and 4096 Bytes.

### **MMCFG Base**

Use this item to select the low base address for PCIE adapters to increase base memory. The options are 1G, 1.5G, 1.75G, **2G**, 2.25G. and 3G.

### **NVMe Firmware Source**

Use this item to select the NVMe firmware to support booting. The options are **Vendor Defined Firmware** and AMI Native Support. The default option, Vendor Defined Firmware, is pre-installed on the drive and may resolve errata or enable innovative functions for the drive. The other option, AMI Native Support, is offered by the BIOS with a generic method.

### **VGA Priority**

Use this feature to select VGA priority when multiple VGA devices are detected. Select Onboard to give priority to your onboard video device. Select Offboard to give priority to your graphics card. The options are **Onboard** and Offboard.

### **PCH SLOT1 PCI-E 3.0 X4 (IN X8) OPROM**

Use this feature to select which firmware type to be loaded for the add-on card in this slot. The options are Disabled, **Legacy**, and EFI.

### **CPU SLOT2 PCI-E 3.0 X8 OPROM**

Use this feature to select which firmware type to be loaded for the add-on card in this slot. The options are Disabled, **Legacy**, and EFI.

### **CPU SLOT3 PCI-E 3.0 X8 OPROM**

Use this feature to select which firmware type to be loaded for the add-on card in this slot. The options are Disabled, **Legacy**, and EFI.

### **CPU SLOT4 PCI-E 3.0 X8 (IN X16) OPROM**

Use this feature to select which firmware type to be loaded for the add-on card in this slot. The options are Disabled, **Legacy**, and EFI.

### **CPU SLOT5 PCI-E 3.0 X8 OPROM**

Use this feature to select which firmware type to be loaded for the add-on card in this slot. The options are Disabled, **Legacy**, and EFI.

### **CPU SLOT6 PCI-E 3.0 X8 (IN X16) OPROM**

Use this feature to select which firmware type to be loaded for the add-on card in this slot. The options are Disabled, **Legacy**, and EFI.

### **CPU SLOT7 PCI-E 3.0 X8 OPROM**

Use this feature to select which firmware type to be loaded for the add-on card in this slot. The options are Disabled, **Legacy**, and EFI.

### **M.2 PCI-E 3.0 X4 OPROM**

Use this feature to select which firmware type to be loaded for the add-on card in this slot. The options are Disabled, **Legacy**, and EFI.

### **Onboard LAN Option ROM Type**

Use to feature to enable Option ROM support to boot the computer using a network device specified by the user. The options are **Legacy** and EFI.

### **Onboard LAN1 Option ROM**

Use this feature to select which firmware function to be loaded for LAN Port1 used for system boot. The options are Disabled, **PXE**, and iSCSI.

### **Onboard LAN2 Option ROM**

Use this feature to select which firmware function to be loaded for LAN Port2 used for system boot. The options are **Disabled** and PXE.

### **Onboard Video Option ROM**

Use this item to select the Onboard Video Option ROM type. The options are Disabled, **Legacy**, and EFI.

## **► Network Stack Configuration**

### **Network Stack**

Select Enabled to enable PXE (Preboot Execution Environment) or UEFI (Unified Extensible Firmware Interface) for network stack support. The options are **Enabled** and Disabled.

### **Ipv4 PXE Support**

Select Enabled to enable IPv4 PXE boot support. The options are Disabled and **Enabled**.

### **Ipv4 HTTP Support**

Select Enabled to enable IPv4 HTTP boot support. The options are **Disabled** and Enabled.

### **Ipv6 PXE Support**

Select Enabled to enable IPv6 PXE boot support. The options are Disabled and **Enabled**.

### **Ipv6 HTTP Support**

Select Enabled to enable IPv6 HTTP boot support. The options are **Disabled** and Enabled.

### **PXE Boot Wait Time**

Use this option to specify the wait time to press the ESC key to abort the PXE boot. Press "+" or "-" on your keyboard to change the value. The default setting is **0**.

### **Media Detect Count**

Use this option to specify the number of times media will be checked. Press "+" or "-" on your keyboard to change the value. The default setting is **1**.

## **► Super IO Configuration**

The following Super IO information will display:

- Super IO Chip AST2500

## ► Serial Port 1 Configuration

This submenu allows the user to configure the settings of Serial Port 1.

### Serial Port 1

Select Enabled to enable the selected onboard serial port. The options are Disabled and Enabled.

### Device Settings

This item displays the status of a serial part specified by the user.

### Change Settings

This feature specifies the base I/O port address and the Interrupt Request address of a serial port specified by the user. Select Auto to allow the BIOS to automatically assign the base I/O and IRQ address.

The options for Serial Port 1 are **Auto**, (IO=3F8h; IRQ=4;), (IO=3F8h; IRQ=3, 4, 5, 6, 7, 9, 10, 11, 12;), (IO=2F8h; IRQ=3, 4, 5, 6, 7, 9, 10, 11, 12;), (IO=3E8h; IRQ=3, 4, 5, 6, 7, 9, 10, 11, 12;), and (IO=2E8h; IRQ=3, 4, 5, 6, 7, 9, 10, 11, 12;).

## ► Serial Port 2 Configuration

This submenu allows the user to configure the settings of Serial Port 2.

### Serial Port 2

Select Enabled to enable the selected onboard serial port. The options are Disabled and Enabled.

### Device Settings

This item displays the status of a serial part specified by the user.

### Change Settings

This feature specifies the base I/O port address and the Interrupt Request address of a serial port specified by the user. Select Auto to allow the BIOS to automatically assign the base I/O and IRQ address.

The options for Serial Port 2 are **Auto**, (IO=2F8h; IRQ=3;), (IO=3F8h; IRQ=3, 4, 5, 6, 7, 9, 10, 11, 12;), (IO=2F8h; IRQ=3, 4, 5, 6, 7, 9, 10, 11, 12;), (IO=3E8h; IRQ=3, 4, 5, 6, 7, 9, 10, 11, 12;), and (IO=2E8h; IRQ=3, 4, 5, 6, 7, 9, 10, 11, 12;).

### Serial Port 2 Attribute (Available for Serial Port 2 only)

Select SOL to use COM Port 2 as a Serial Over LAN (SOL) port for console redirection. The options are **SOL** and COM.

## ► Serial Port Console Redirection

### COM1 Console Redirection

Select Enabled to enable console redirection support for a serial port specified by the user. The options are Enabled and **Disabled**.

*\*If the item above is set to Enabled, the following items will become available for configuration:*

### ► COM1 Console Redirection Settings

Use this feature to specify how the host computer will exchange data with the client computer, which is the remote computer used by the user.

#### COM1 Terminal Type

This feature allows the user to select the target terminal emulation type for Console Redirection. Select VT100 to use the ASCII Character set. Select VT100+ to add color and function key support. Select ANSI to use the Extended ASCII Character Set. Select VT-UTF8 to use UTF8 encoding to map Unicode characters into one or more bytes. The options are VT100, **VT100+**, VT-UTF8, and ANSI.

#### COM1 Bits Per Second

Use this feature to set the transmission speed for a serial port used in Console Redirection. Make sure that the same speed is used in the host computer and the client computer. A lower transmission speed may be required for long and busy lines. The options are 9600, 19200, 38400, 57600 and **115200** (bits per second).

#### COM1 Data Bits

Use this feature to set the data transmission size for Console Redirection. The options are 7 Bits and **8 Bits**.

#### COM1 Parity

A parity bit can be sent along with regular data bits to detect data transmission errors. Select Even if the parity bit is set to 0, and the number of 1's in data bits is even. Select Odd if the parity bit is set to 0, and the number of 1's in data bits is odd. Select None if you do not want to send a parity bit with your data bits in transmission. Select Mark to add a mark as a parity bit to be sent along with the data bits. Select Space to add a Space as a parity bit to be sent with your data bits. The options are **None**, Even, Odd, Mark, and Space.

#### COM1 Stop Bits

A stop bit indicates the end of a serial data packet. Select 1 Stop Bit for standard serial data communication. Select 2 Stop Bits if slower devices are used. The options are **1** and 2.

### **COM1 Flow Control**

Use this feature to set the flow control for Console Redirection to prevent data loss caused by buffer overflow. Send a "Stop" signal to stop sending data when the receiving buffer is full. Send a "Start" signal to start sending data when the receiving buffer is empty. The options are **None** and Hardware RTS/CTS.

### **COM1 VT-UTF8 Combo Key Support**

Select Enabled to enable VT-UTF8 Combination Key support for ANSI/VT100 terminals. The options are Disabled and **Enabled**.

### **COM1 Recorder Mode**

Select Enabled to capture the data displayed on a terminal and send it as text messages to a remote server. The options are **Disabled** and Enabled.

### **COM1 Resolution 100x31**

Select Enabled for extended-terminal resolution support. The options are Disabled and **Enabled**.

### **COM1 Legacy OS Redirection Resolution**

Use this feature to select the number of rows and columns used in Console Redirection for legacy OS support. The options are **80x24** and 80x25.

### **COM1 Putty KeyPad**

This feature selects the settings for Function Keys and KeyPad used for Putty, which is a terminal emulator designed for the Windows OS. The options are **VT100**, LINUX, XTERMR6, SC0, ESCN, and VT400.

### **COM1 Redirection After BIOS POST**

Use this feature to enable or disable legacy console redirection after BIOS POST. When set to Bootloader, legacy console redirection is disabled before booting the OS. When set to Always Enable, legacy console redirection remains enabled when booting the OS. The options are **Always Enable** and Bootloader.

### **SOL/COM2 Console Redirection**

Select Enabled to use the SOL port for Console Redirection. The options are Disabled and **Enabled**.

***\*If the item above is set to Enabled, the following items will become available for configuration:***

## ► SOL/COM2 Console Redirection Settings

Use this feature to specify how the host computer will exchange data with the client computer, which is the remote computer used by the user.

### COM2 Terminal Type

Use this feature to select the target terminal emulation type for Console Redirection. Select VT100 to use the ASCII Character set. Select VT100+ to add color and function key support. Select ANSI to use the Extended ASCII Character Set. Select VT-UTF8 to use UTF8 encoding to map Unicode characters into one or more bytes. The options are ANSI, VT100, **VT100+**, and VT-UTF8.

### COM2 Bits Per Second

Use this feature to set the transmission speed for a serial port used in Console Redirection. Make sure that the same speed is used in the host computer and the client computer. A lower transmission speed may be required for long and busy lines. The options are 9600, 19200, 38400, 57600 and **115200** (bits per second).

### COM2 Data Bits

Use this feature to set the data transmission size for Console Redirection. The options are 7 Bits and **8 Bits**.

### COM2 Parity

A parity bit can be sent along with regular data bits to detect data transmission errors. Select Even if the parity bit is set to 0, and the number of 1's in data bits is even. Select Odd if the parity bit is set to 0, and the number of 1's in data bits is odd. Select None if you do not want to send a parity bit with your data bits in transmission. Select Mark to add a mark as a parity bit to be sent along with the data bits. Select Space to add a Space as a parity bit to be sent with your data bits. The options are **None**, Even, Odd, Mark and Space.

### COM2 Stop Bits

A stop bit indicates the end of a serial data packet. Select 1 Stop Bit for standard serial data communication. Select 2 Stop Bits if slower devices are used. The options are **1** and 2.

### COM2 Flow Control

Use this feature to set the flow control for Console Redirection to prevent data loss caused by buffer overflow. Send a "Stop" signal to stop sending data when the receiving buffer is full. Send a "Start" signal to start sending data when the receiving buffer is empty. The options are **None** and Hardware RTS/CTS.

### COM2 VT-UTF8 Combo Key Support

Select Enabled to enable VT-UTF8 Combination Key support for ANSI/VT100 terminals. The options are Disabled and **Enabled**.

### **COM2 Recorder Mode**

Select Enabled to capture the data displayed on a terminal and send it as text messages to a remote server. The options are **Disabled** and Enabled.

### **COM2 Resolution 100x31**

Select Enabled for extended-terminal resolution support. The options are Disabled and **Enabled**.

### **COM2 Legacy OS Redirection Resolution**

Use this feature to select the number of rows and columns used in Console Redirection for legacy OS support. The options are **80x24** and 80x25.

### **COM2 Putty KeyPad**

This feature selects Function Keys and KeyPad settings for Putty, which is a terminal emulator designed for the Windows OS. The options are **VT100**, LINUX, XTERMR6, SCO, ESCN, and VT400.

### **COM2 Redirection After BIOS POST**

Use this feature to enable or disable legacy Console Redirection after BIOS POST. When set to Bootloader, legacy Console Redirection is disabled before booting the OS. When set to Always Enable, legacy Console Redirection remains enabled when booting the OS. The options are **Always Enable** and Bootloader.

## **Legacy Console Redirection**

### **Legacy Serial Redirection Port**

Use this feature to select a COM port to display redirection of Legacy OS and Legacy OPROM messages. The options are **COM1** and SOL/COM2.

### **EMS (Emergency Management Services) Console Redirection**

Select Enabled to use a COM port selected by the user for EMS Console Redirection. The options are Enabled and **Disabled**.

***\*If the item above is set to Enabled, the following items will become available for configuration:***

### **► EMS Console Redirection Settings**

This feature allows the user to specify how the host computer will exchange data with the client computer, which is the remote computer used by the user.

### **Out-of-Band Mgmt Port**

The feature selects a serial port in a client server to be used by the Microsoft Windows Emergency Management Services (EMS) to communicate with a remote host server. The options are **COM1** and SOL/COM2.

### **Terminal Type**

Use this feature to select the target terminal emulation type for Console Redirection. Select VT100 to use the ASCII character set. Select VT100+ to add color and function key support. Select ANSI to use the extended ASCII character set. Select VT-UTF8 to use UTF8 encoding to map Unicode characters into one or more bytes. The options are VT100, VT100+, **VT-UTF8**, and ANSI.

### **Bits Per Second**

This item sets the transmission speed for a serial port used in Console Redirection. Make sure that the same speed is used in the host computer and the client computer. A lower transmission speed may be required for long and busy lines. The options are 9600, 19200, 57600, and **115200** (bits per second).

### **Flow Control**

Use this item to set the flow control for Console Redirection to prevent data loss caused by buffer overflow. Send a "Stop" signal to stop sending data when the receiving buffer is full. Send a "Start" signal to start sending data when the receiving buffer is empty. The options are **None**, Hardware RTS/CTS, and Software Xon/Xoff.

### **Data Bits, Parity, Stop Bits**

## **►ACPI Settings**

### **WHEA Support**

Select Enabled to support the Windows Hardware Error Architecture (WHEA) platform and provide a common infrastructure for the system to handle hardware errors within the Windows OS environment to reduce system crashes and to enhance system recovery and health monitoring. The options are Disabled and **Enabled**.

### **High Precision Event Timer**

Select Enabled to activate the High Precision Event Timer (HPET) that produces periodic interrupts at a much higher frequency than a Real-time Clock (RTC) does in synchronizing multimedia streams, providing smooth playback and reducing the dependency on other timestamp calculation devices, such as an x86 RDTSC Instruction embedded in the CPU. The High Performance Event Timer is used to replace the 8254 Programmable Interval Timer. The options are Disabled and **Enabled**.

## ► Trusted Computing

The X11SPL-F supports TPM 1.2 and 2.0. The following Trusted Platform Module (TPM) information will display if a TPM 2.0 module is detected:

- Vendor Name
- Firmware Version

### Security Device Support

If this feature and the TPM jumper on the motherboard are both set to Enabled, onboard security devices will be enabled for TPM (Trusted Platform Module) support to enhance data integrity and network security. Please reboot the system for a change on this setting to take effect. The options are Disable and **Enable**.

- Active PCR Bank
- SHA256 PCR Bank

***\*If the item above is set to Enable, "SHA-1 PCR Bank" and "SHA256 PCR Bank" will become available for configuration:***

#### SHA-1 PCR Bank

Use this item to disable or enable the SHA-1 Platform Configuration Register (PCR) bank for the installed TPM device. The options are Disabled and **Enabled**.

#### SHA256 PCR Bank

Use this item to disable or enable the SHA256 Platform Configuration Register (PCR) bank for the installed TPM device. The options are Disabled and **Enabled**.

#### Pending Operation

Use this item to schedule a TPM-related operation to be performed by a security device for system data integrity. Your system will reboot to carry out a pending TPM operation. The options are **None** and TPM Clear.

#### Platform Hierarchy

Use this item to disable or enable platform hierarchy for platform protection. The options are Disabled and **Enabled**.

#### Storage Hierarchy

Use this item to disable or enable storage hierarchy for cryptographic protection. The options are Disabled and **Enabled**.

### **Endorsement Hierarchy**

Use this item to disable or enable endorsement hierarchy for privacy control. The options are Disabled and **Enabled**.

### **PH Randomization**

Use this item to disable or enable Platform Hierarchy (PH) Randomization. The options are **Disabled** and Enabled.

### **TXT Support**

Intel Trusted Execution Technology (TXT) helps protect against software-based attacks and ensures protection, confidentiality, and integrity of data stored or created on the system. Use this feature to enable or disable TXT Support. The options are **Disable** and Enable.

## **► iSCSI Configuration**

### **iSCSI Initiator Name**

This feature allows the user to enter the unique name of the iSCSI Initiator in IQN format. Once the name of the iSCSI Initiator is entered into the system, configure the proper settings for the following items.

► **Add an Attempt**

► **Delete Attempts**

► **Change Attempt Order**

## **► Intel(R) Virtual RAID on CPU**

Intel(R) VROC with VMD Technology 5.1.0.1007

RAID volumes and Intel VMD Controllers information will be displayed if they are detected by the system.

## 4.4 Event Logs

Use this feature to configure Event Log settings.

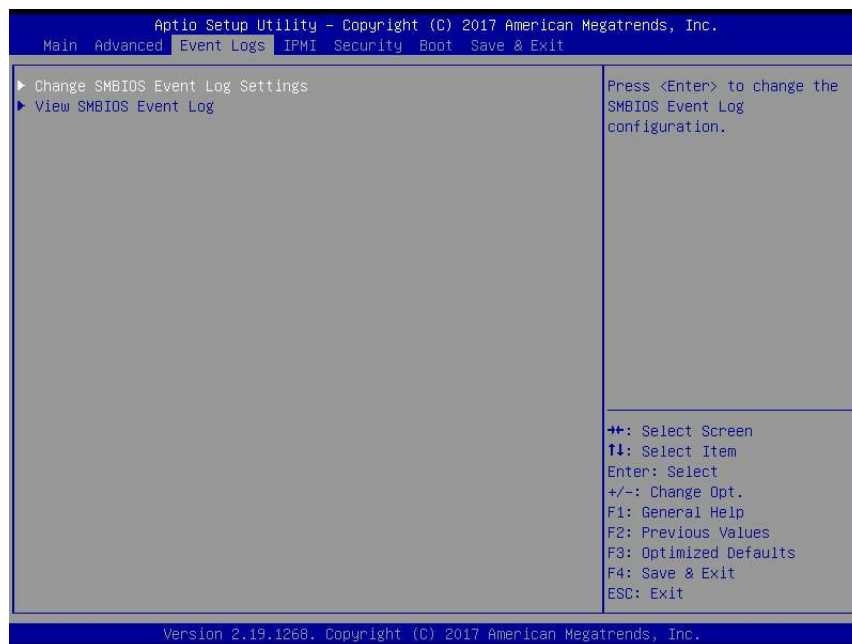

### ► Change SMBIOS Event Log Settings

#### Enabling/Disabling Options

#### SMBIOS Event Log

Change this item to enable or disable all features of the SMBIOS Event Logging during system boot. The options are **Enabled** and Disabled.

#### Erasing Settings

#### Erase Event Log

If No is selected, data stored in the event log will not be erased. Select Yes, Next Reset, data in the event log will be erased upon next system reboot. Select Yes, Every Reset, data in the event log will be erased upon every system reboot. The options are **No**, Yes, Next reset, and Yes, Every reset.

#### When Log is Full

Select Erase Immediately for all messages to be automatically erased from the event log when the event log memory is full. The options are **Do Nothing** and Erase Immediately.

## **SMBIOS Event Log Standard Settings**

### **Log System Boot Event**

This option toggles the System Boot Event logging to enabled or disabled. The options are **Disabled** and **Enabled**.

### **MECI**

The Multiple Event Count Increment (MECI) counter counts the number of occurrences that a duplicate event must happen before the MECI counter is incremented. This is a numeric value. The default value is **1**.

### **METW**

The Multiple Event Time Window (METW) defines the number of minutes that must pass between duplicate log events before MECI is incremented. This is in minutes, from 0 to 99. The default value is **60**.



**Note:** After making changes on a setting, be sure to reboot the system for the changes to take effect.

### **►View SMBIOS Event Log**

Select this submenu and press enter to see the contents of the SMBIOS event log. The following categories will be displayed: Date/Time/Error Codes/Severity.

## 4.5 IPMI

Use this feature to configure Intelligent Platform Management Interface (IPMI) settings.



### BMC Firmware Revision

This item indicates the IPMI firmware revision used in your system.

### IPMI Status (Baseboard Management Controller)

This item indicates the status of the IPMI firmware installed in your system.

### ▶ System Event Log

#### Enabling/Disabling Options

#### SEL Components

Select Enabled for all system event logging at bootup. The options are **Enabled** and Disabled.

#### Erasing Settings

#### Erase SEL

Select Yes, On next reset to erase all system event logs upon next system reboot. Select Yes, On every reset to erase all system event logs upon each system reboot. Select No to keep all system event logs after each system reboot. The options are **No**, Yes, On next reset, and Yes, On every reset.

### When SEL is Full

This feature allows the user to decide what the BIOS should do when the system event log is full. Select Erase Immediately to erase all events in the log when the system event log is full. The options are **Do Nothing** and Erase Immediately.



**Note:** After making changes on a setting, be sure to reboot the system for the changes to take effect.

## ► BMC Network Configuration

### BMC Network Configuration

#### Configure IPV4 Support

This section displays configuration features for IPV4 support.

#### IPMI LAN Selection

This item displays the IPMI LAN setting. The default setting is **Failover**.

#### IPMI Network Link Status

This item displays the IPMI Network Link status. The default setting is **Shared LAN**.

#### Update IPMI LAN Configuration

Select Yes for the BIOS to implement all IP/MAC address changes at the next system boot. The options are **No** and Yes.

***\*If the item above is set to Yes, the following item will become available for configuration:***

#### Configuration Address Source

This feature allows the user to select the source of the IP address for this computer. If Static is selected, you will need to know the IP address of this computer and enter it to the system manually in the field. If DHCP is selected, the BIOS will search for a DHCP (Dynamic Host Configuration Protocol) server in the network that is attached to and request the next available IP address for this computer. The options are **DHCP** and Static.

***\*If the item above is set to Static, the following items will become available for configuration:***

#### Station IP Address

This item displays the Station IP address for this computer. This should be in decimal and in dotted quad form (i.e., 192.168.10.253).

#### Subnet Mask

This item displays the sub-network that this computer belongs to. The value of each three-digit number separated by dots should not exceed 255.

### **Station MAC Address**

This item displays the Station MAC address for this computer. Mac addresses are 6 two-digit hexadecimal numbers.

### **Gateway IP Address**

This item displays the Gateway IP address for this computer. This should be in decimal and in dotted quad form (i.e., 172.31.0.1).

### **VLAN**

This item displays the virtual LAN settings. The options are **Disable** and **Enable**.

### **Configure IPV6 Support**

This section displays configuration features for IPV6 support.

#### **LAN Channel 1**

#### **IPV6 Support**

Use this feature to enable IPV6 support. The options are **Enabled** and **Disabled**.

#### **Configuration Address Source**

This feature allows the user to select the source of the IP address for this computer. If **Static** is selected, you will need to know the IP address of this computer and enter it to the system manually in the field. If **DHCP** is selected, the BIOS will search for a DHCP (Dynamic Host Configuration Protocol) server in the network that is attached to and request the next available IP address for this computer. The options are **Unspecified**, **Static**, and **DHCP**.

***\*If the item above is set to Static, the following items will become available for configuration:***

- Station IPV6 Address
- Prefix Length
- IPV6 Router1 IP Address

## 4.6 Security

This menu allows the user to configure the following security settings for the system.

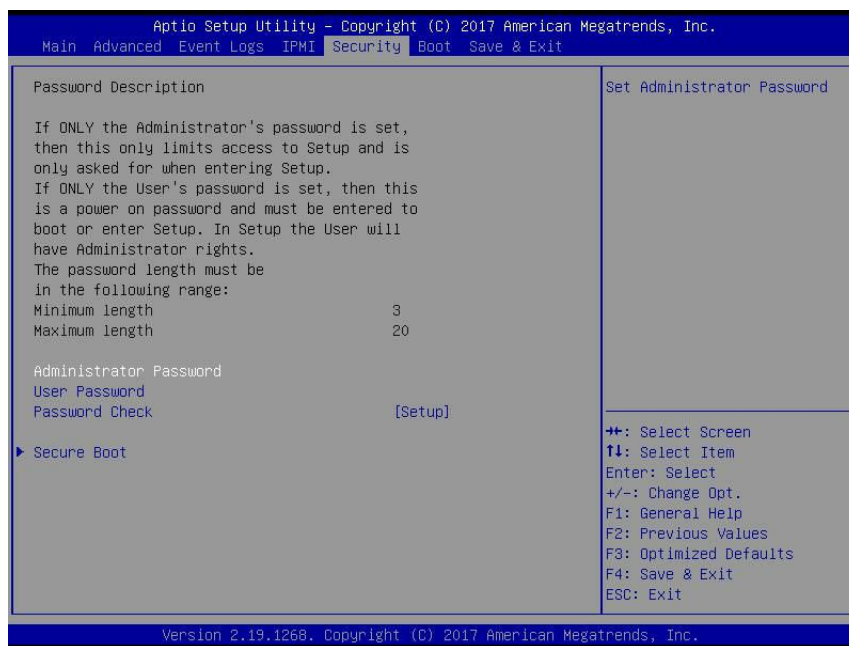

### Administrator Password

Press Enter to create a new, or change an existing, Administrator password.

### User Password

Press Enter to create a new, or change an existing, User password.

### Password Check

Select Setup for the system to check for a password at Setup. Select Always for the system to check for a password at bootup or upon entering the BIOS Setup utility. The options are **Setup** and **Always**.

### ► Secure Boot

This section displays the contents of the following secure boot features:

- System Mode
- Secure Boot
- Vendor Keys

### Secure Boot

Use this item to enable secure boot. The options are **Disabled** and **Enabled**.

### **Secure Boot Mode**

Use this item to configure Secure Boot variables without authentication. The options are Standard and **Custom**.

### **CSM Support**

Select Enabled to support the EFI Compatibility Support Module (CSM), which provides compatibility support for traditional legacy BIOS for system boot. The options are **Enabled** and Disabled.

### **▶ Key Management**

This submenu allows the user to configure the following Key Management settings.

#### **Provision Factory Default Keys**

Select Enabled to install the default Secure Boot keys set by the manufacturer. The options are **Disabled** and Enabled.

#### **▶ Enroll All Factory Default Keys**

Select Yes to install all default secure keys set by the manufacturer. The options are **Yes** and No.

#### **▶ Enroll EFI Image**

This feature allows the image to run in Secure Boot Mode. Enroll SHA256 Hash Certificate of the image into the Authorized Signature Database.

#### **▶ Save All Secure Boot Variables**

This feature allows the user to decide if all secure boot variables should be saved.

#### **▶ Platform Key (PK)**

This feature allows the user to configure the settings of the platform keys.

### **Set New**

Select Yes to load the new platform keys (PK) from the manufacturer's defaults. Select No to load the platform keys from a file. The options are **Yes** and No.

## ▶ Key Exchange Keys

### Set New

Select Yes to load the KEK from the manufacturer's defaults. Select No to load the KEK from a file. The options are Yes and No.

### Append

Select Yes to add the KEK from the manufacturer's defaults list to the existing KEK. Select No to load the KEK from a file. The options are Yes and No.

## ▶ Authorized Signatures

### Set New

Select Yes to load the database from the manufacturer's defaults. Select No to load the DB from a file. The options are Yes and No.

### Append

Select Yes to add the database from the manufacturer's defaults to the existing DB. Select No to load the DB from a file. The options are Yes and No.

## ▶ Forbidden Signatures

### Set New

Select Yes to load the DBX from the manufacturer's defaults. Select No to load the DBX from a file. The options are Yes and No.

### Append

Select Yes to add the DBX from the manufacturer's defaults to the existing DBX. Select No to load the DBX from a file. The options are Yes and No.

## ▶ Authorized TimeStamps

### Set New

Select Yes to load the DBT from the manufacturer's defaults. Select No to load the DBT from a file. The options are Yes and No.

### Append

Select Yes to add the DBT from the manufacturer's defaults list to the existing DBT. Select No to load the DBT from a file. The options are Yes and No.

## ► OsRecovery Signature

This item uploads and installs an OSRecovery Signature. You may insert a factory default key or load from a file. The file formats accepted are:

- 1) Public Key Certificate
  - a. EFI Signature List
  - b. EFI CERT X509 (DER Encoded)
  - c. EFI CERT RSA2048 (bin)
  - d. EFI SERT SHA256 (bin)
- 2) EFI Time Based Authenticated Variable

When prompted, select "Yes" to load Factory Defaults or "No" to load from a file.

### **Set New**

Select Yes to load the DBR from the manufacturer's defaults. Select No to load the DBR from a file. The options are Yes and No.

### **Append**

This item uploads and adds an OSRecovery Signature into the Key Management. You may insert a factory default key or load from a file. When prompted, select "Yes" to load Factory Defaults or "No" to load from a file.

## 4.7 Boot

Use this feature to configure Boot settings.

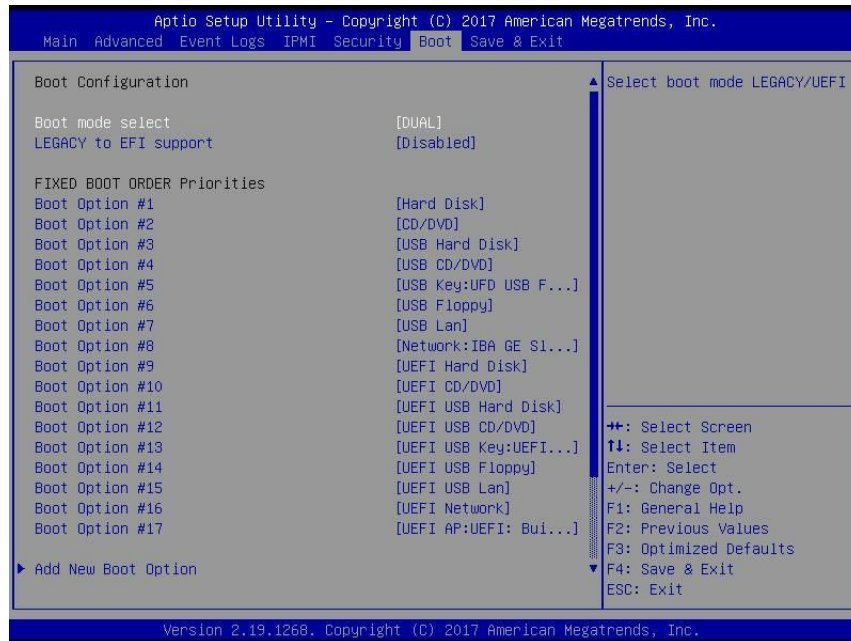

### Boot Mode Select

Use this item to select the type of device that the system is going to boot from. The options are Legacy, UEFI, and **Dual**.

### Legacy to EFI Support

Select Enabled to boot EFI OS support after Legacy boot order has failed. The options are **Disabled** and Enabled.

### Fixed Boot Order Priorities

This option prioritizes the order of bootable devices that the system boots from. Press <Enter> on each entry from top to bottom to select devices.

***\*If the item "Boot Mode Select" above is set to Legacy, UEFI, or Dual, the following items will be displayed:***

- Legacy/UEFI/Dual Boot Option #1
- Legacy/UEFI/Dual Boot Option #2
- Legacy/UEFI/Dual Boot Option #3
- Legacy/UEFI/Dual Boot Option #4
- Legacy/UEFI/Dual Boot Option #5

- Legacy/UEFI/Dual Boot Option #6
- Legacy/UEFI/Dual Boot Option #7
- Legacy/UEFI/Dual Boot Option #8
- UEFI/Dual Boot Option #9
- Dual Boot Option #10
- Dual Boot Option #11
- Dual Boot Option #12
- Dual Boot Option #13
- Dual Boot Option #14
- Dual Boot Option #15
- Dual Boot Option #16
- Dual Boot Option #17

### ► **Delete Boot Option**

This feature allows the user to select a boot device to delete from the boot priority list.

#### **Delete Boot Option**

Use this item to remove an EFI boot option from the boot priority list.

### ► **NETWORK Drive BBS Priorities**

This feature sets the system boot order of detected devices.

- Boot Option #1

### ► **UEFI Application Boot Priorities**

This feature allows the user to specify which UEFI devices are boot devices.

- UEFI Boot Option #1

*\*If any storage media is detected, the following items will become available for configuration:*

### ► Add New Boot Option

This feature allows the user to add a new boot option to the boot priority features for your system.

#### **Add Boot Option**

Use this item to specify the name for the new boot option.

#### **Path for Boot Option**

Use this item to enter the path for the new boot option in the format fsx:\path\filename.efi.

#### **Boot Option File Path**

Use this item to specify the file path for the new boot option.

#### **Create**

Use this item to set the name and the file path of the new boot option.

### ► UEFI Hard Disk Drive BBS Priorities

This feature sets the system boot order of detected devices.

- Boot Option #1

### ► Hard Disk Drive BBS Priorities

This feature sets the system boot order of detected devices.

- Boot Option #1

## 4.8 Save & Exit

Select the Save & Exit tab from the BIOS setup screen to configure the settings below:

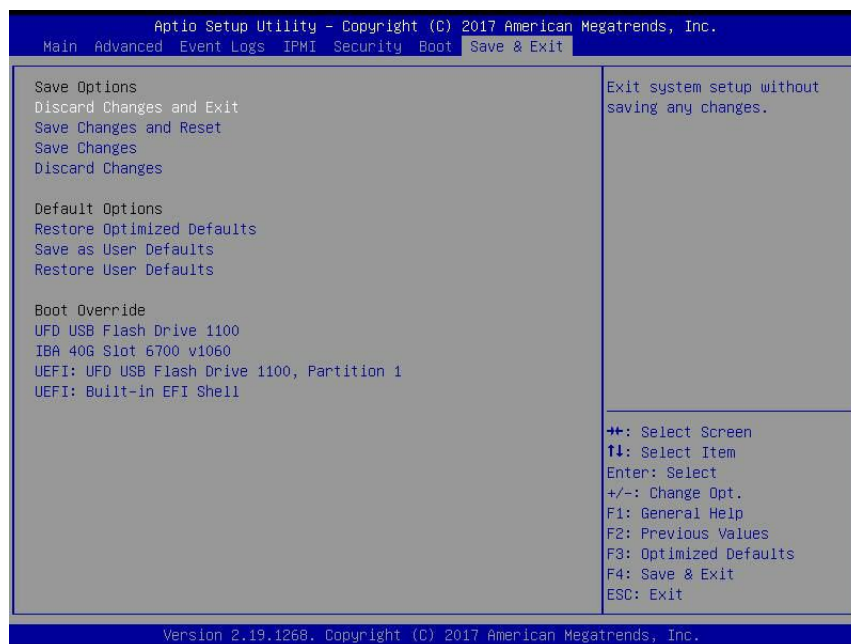

### Save Options

#### Discard Changes and Exit

Select this option to quit the BIOS Setup without making any permanent changes to the system configuration and reboot the computer. Select Discard Changes and Exit from the Save & Exit menu and press <Enter>.

#### Save Changes and Reset

After completing the system configuration changes, select this option to save the changes you have made. This will not reset (reboot) the system.

#### Save Changes

When you have completed the system configuration changes, select this option to leave the BIOS setup utility and reboot the computer for the new system configuration parameters to take effect. Select Save Changes from the Save & Exit menu and press <Enter>.

#### Discard Changes

Select this option and press <Enter> to discard all the changes and return to the AMI BIOS utility program.

## **Default Options**

### **Restore Optimized Defaults**

To set this feature, select Restore Defaults from the Save & Exit menu and press <Enter>. These are factory settings designed for maximum system stability, but not for maximum performance.

### **Save As User Defaults**

To set this feature, select Save as User Defaults from the Save & Exit menu and press <Enter>. This enables the user to save any changes to the BIOS setup for future use.

### **Restore User Defaults**

To set this feature, select Restore User Defaults from the Save & Exit menu and press <Enter>. Use this feature to retrieve user-defined settings that were saved previously.

### **Boot Override**

Listed in this section are other boot options for the system (i.e., Built-in EFI shell). Select an option and press <Enter>. Your system will boot to the selected boot option.

## Appendix A

### BIOS Codes

#### A.1 BIOS Error POST (Beep) Codes

During the POST (Power-On Self-Test) routines, which are performed each time the system is powered on, errors may occur.

**Non-fatal errors** are those which, in most cases, allow the system to continue the boot-up process. The error messages normally appear on the screen.

**Fatal errors** are those which will not allow the system to continue the boot-up procedure. If a fatal error occurs, you should consult with your system manufacturer for possible repairs.

These fatal errors are usually communicated through a series of audible beeps. The table shown below lists some common errors and their corresponding beep codes encountered by users.

BIOS Beep (POST) Codes		
Beep Code	Error Message	Description
1 beep	Refresh	Circuits have been reset (Ready to power up)
5 short, 1 long	Memory error	No memory detected in system
5 long, 2 short	Display memory read/write error	Video adapter missing or with faulty memory
1 long continuous	System OH	System overheat condition

## A.2 Additional BIOS POST Codes

The AMI BIOS supplies additional checkpoint codes, which are documented online at <http://www.supermicro.com/support/manuals/> ("AMI BIOS POST Codes User's Guide").

When BIOS performs the Power On Self Test, it writes checkpoint codes to I/O port 0080h. If the computer cannot complete the boot process, a diagnostic card can be attached to the computer to read I/O port 0080h (Supermicro p/n AOC-LPC80-20).

For information on AMI updates, please refer to <http://www.ami.com/products/>.

## Appendix B

### Software Installation

#### B.1 Installing Software Programs

The Supermicro FTP site contains drivers and utilities for your system at <ftp://ftp.supermicro.com>. Some of these must be installed, such as the chipset driver.

After accessing the FTP site, go into the CDR\_Images directory and locate the ISO file for your motherboard. Download this file to create a CD/DVD of the drivers and utilities it contains. (You may also use a utility to extract the ISO file if preferred.)

After creating a CD/DVD with the ISO files, insert the disk into the CD/DVD drive on your system and the display shown in Figure B-1 should appear.

Another option is to go to the Supermicro website at <http://www.supermicro.com/products/>. Find the product page for your motherboard here, where you may download individual drivers and utilities to your hard drive or a USB flash drive and install from there.

 **Note:** To install the Windows OS, please refer to the instructions posted on our website at <http://www.supermicro.com/support/manuals/>.

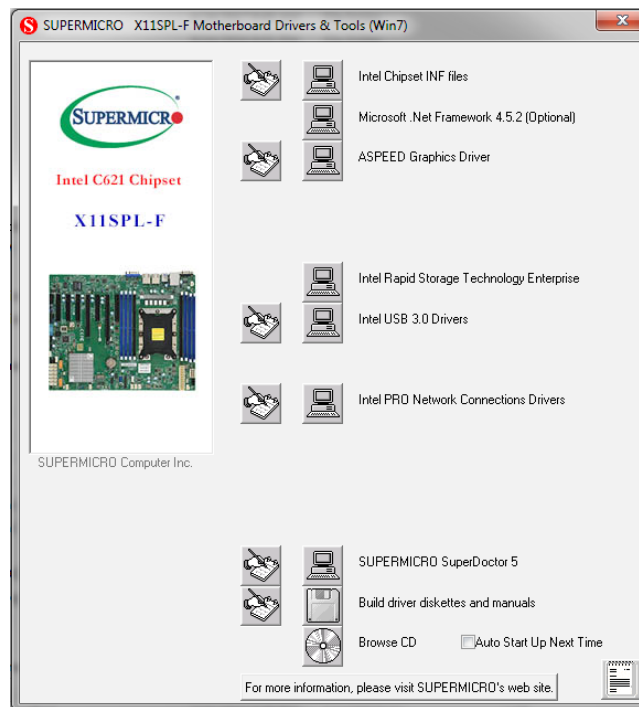

Figure B-1. Driver/Tool Installation Display Screen

Click the icons showing a hand writing on the paper to view the readme files for each item. Click a computer icon to the right of an item to install an item (from top to bottom) one at a time. After installing each item, you must reboot the system before proceeding with the next item on the list. The bottom icon with a CD on it allows you to view the entire contents of the CD.

When making a storage driver diskette by booting into a driver CD, please set the SATA Configuration to "Compatible Mode" and configure SATA as IDE in the BIOS Setup. After making the driver diskette, be sure to change the SATA settings back to your original settings.

## B.2 SuperDoctor® 5

The Supermicro SuperDoctor 5 is a hardware monitoring program that functions in a command-line or web-based interface in Windows and Linux operating systems. The program monitors system health information such as CPU temperature, system voltages, system power consumption, fan speed, and provides alerts via email or Simple Network Management Protocol (SNMP).

SuperDoctor 5 comes in local and remote management versions and can be used with Nagios to maximize your system monitoring needs. With SuperDoctor 5 Management Server (SSM Server), you can remotely control power on/off and reset chassis intrusion for multiple systems with SuperDoctor 5 or IPMI. SD5 Management Server monitors HTTP, FTP, and SMTP services to optimize the efficiency of your operation.



**Note:** The default Username and Password for SuperDoctor 5 is admin / admin.

**Figure B-2. SuperDoctor 5 Interface Display Screen (Health Information)**

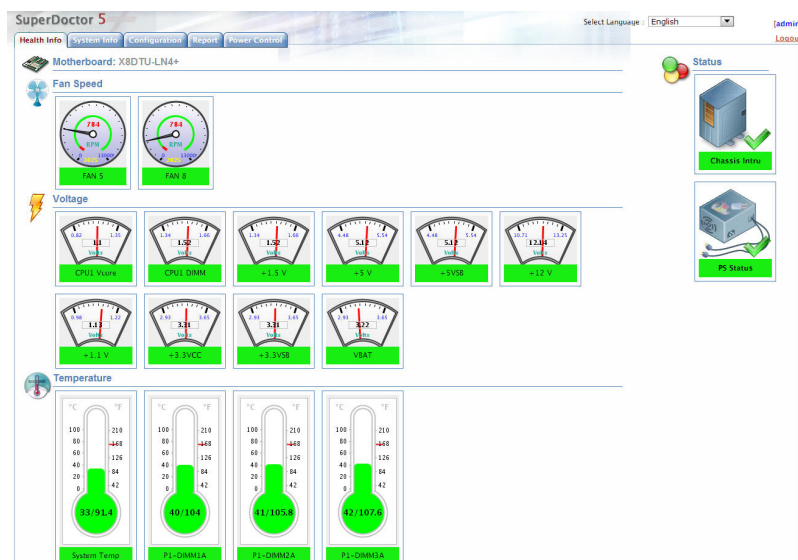

**Note:** The SuperDoctor 5 program and user's manual can be downloaded from the Supermicro website at [http://www.supermicro.com/products/info/sms\\_sd5.cfm](http://www.supermicro.com/products/info/sms_sd5.cfm).

## Appendix C

### Standardized Warning Statements

The following statements are industry standard warnings, provided to warn the user of situations which have the potential for bodily injury. Should you have questions or experience difficulty, contact Supermicro's Technical Support department for assistance. Only certified technicians should attempt to install or configure components.

Read this section in its entirety before installing or configuring components.

These warnings may also be found on our website at [http://www.supermicro.com/about/policies/safety\\_information.cfm](http://www.supermicro.com/about/policies/safety_information.cfm).

#### Battery Handling



**Warning!** There is the danger of explosion if the battery is replaced incorrectly. Replace the battery only with the same or equivalent type recommended by the manufacturer. Dispose of used batteries according to the manufacturer's instructions

#### 電池の取り扱い

電池交換が正しく行われなかった場合、破裂の危険性があります。交換する電池はメーカーが推奨する型、または同等のものを使用下さい。使用済電池は製造元の指示に従って処分して下さい。

#### 警告

電池更換不當會有爆炸危險。請只使用同類電池或制造商推薦的功能相當的電池更換原有電池。請按製造商的說明處理廢舊電池。

#### 警告

電池更換不當會有爆炸危險。請使用製造商建議之相同或功能相當的電池更換原有電池。請按照製造商的說明指示處理廢棄舊電池。

#### Warnung

Bei Einsetzen einer falschen Batterie besteht Explosionsgefahr. Ersetzen Sie die Batterie nur durch den gleichen oder vom Hersteller empfohlenen Batterietyp. Entsorgen Sie die benutzten Batterien nach den Anweisungen des Herstellers.

**Attention**

Danger d'explosion si la pile n'est pas remplacée correctement. Ne la remplacer que par une pile de type semblable ou équivalent, recommandée par le fabricant. Jeter les piles usagées conformément aux instructions du fabricant.

**¡Advertencia!**

Existe peligro de explosión si la batería se reemplaza de manera incorrecta. Reemplazar la batería exclusivamente con el mismo tipo o el equivalente recomendado por el fabricante. Desechar las baterías gastadas según las instrucciones del fabricante.

**אזהרה!**

קיימת סכנת פיצוץ של הסוללה במידה והוחלפה בדרך לא תקינה. יש להחליף את הסוללה בסוג התואם מחברת יצרן מומלצת. סילוק הסוללות המשומשות יש לבצע לפי הוראות היצרן.

هناك خطر من انفجار في حالة اسبدال البطارية بطريقة غير صحيحة فعلي  
اسبدال البطارية فقط بنفس النوع أو ما يعادلها مما أوصت به الشركة المصنعة  
جخلص من البطاريات المسحمة وفقا لعمليات الشركة الصانعة

**경고!**

배터리가 올바르게 교체되지 않으면 폭발의 위험이 있습니다. 기존 배터리와 동일하거나 제조사에서 권장하는 동등한 종류의 배터리로만 교체해야 합니다. 제조사의 안내에 따라 사용된 배터리를 처리하여 주십시오.

**Waarschuwing**

Er is ontploffingsgevaar indien de batterij verkeerd vervangen wordt. Vervang de batterij slechts met hetzelfde of een equivalent type die door de fabrikant aanbevolen wordt. Gebruikte batterijen dienen overeenkomstig fabrieksvoorschriften afgevoerd te worden.

## Product Disposal



**Warning!** Ultimate disposal of this product should be handled according to all national laws and regulations.

### 製品の廃棄

この製品を廃棄処分する場合、国の関係する全ての法律・条例に従い処理する必要があります。

### 警告

本产品的废弃处理应根据所有国家的法律和规章进行。

### 警告

本產品的廢棄處理應根據所有國家的法律和規章進行。

### Warnung

Die Entsorgung dieses Produkts sollte gemäß allen Bestimmungen und Gesetzen des Landes erfolgen.

### ¡Advertencia!

Al deshacerse por completo de este producto debe seguir todas las leyes y reglamentos nacionales.

### Attention

La mise au rebut ou le recyclage de ce produit sont généralement soumis à des lois et/ou directives de respect de l'environnement. Renseignez-vous auprès de l'organisme compétent.

סילוק המוצר

אזהרה!

סילוק סופי של מוצר זה חייב להיות בהתאם להנחיות וחוקי המדינה.

عند التخلص النهائي من هذا المنتج ينبغي التعامل معه وفقا لجميع القوانين واللوائح الوطنية

### 경고!

이 제품은 해당 국가의 관련 법규 및 규정에 따라 폐기되어야 합니다.

### Waarschuwing

De uiteindelijke verwijdering van dit product dient te geschieden in overeenstemming met alle nationale wetten en reglementen.

## Appendix D

### UEFI BIOS Recovery

**Warning:** Do not upgrade the BIOS unless your system has a BIOS-related issue. Flashing the wrong BIOS can cause irreparable damage to the system. In no event shall Supermicro be liable for direct, indirect, special, incidental, or consequential damages arising from a BIOS update. If you need to update the BIOS, do not shut down or reset the system while the BIOS is updating to avoid possible boot failure.

#### D.1 Overview

The Unified Extensible Firmware Interface (UEFI) provides a software-based interface between the operating system and the platform firmware in the pre-boot environment. The UEFI specification supports an architecture-independent mechanism that will allow the UEFI OS loader stored in an add-on card to boot the system. The UEFI offers clean, hands-off management to a computer during system boot.

#### D.2 Recovering the UEFI BIOS Image

A UEFI BIOS flash chip consists of a recovery BIOS block and a main BIOS block (a main BIOS image). The recovery block contains critical BIOS codes, including memory detection and recovery codes for the user to flash a healthy BIOS image if the original main BIOS image is corrupted. When the system power is first turned on, the boot block codes execute first. Once this process is completed, the main BIOS code will continue with system initialization and the remaining POST (Power-On Self-Test) routines.



**Note 1:** Follow the BIOS recovery instructions below for BIOS recovery when the main BIOS block crashes.

**Note 2:** When the BIOS recovery block crashes, you will need to follow the procedures to make a Returned Merchandise Authorization (RMA) request. (For a RMA request, please see section 3.5 for more information). Also, you may use the Supermicro Update Manager (SUM) Out-of-Band (OOB) ([https://www.supermicro.com.tw/products/nfo/SMS\\_SUM.cfm](https://www.supermicro.com.tw/products/nfo/SMS_SUM.cfm)) to reflash the BIOS.

#### D.3 Recovering the BIOS Block with a USB Device

This feature allows the user to recover the main BIOS image using a USB-attached device without additional utilities used. A USB flash device such as a USB Flash Drive, or a USB CD/DVD ROM/RW device can be used for this purpose. However, a USB Hard Disk drive cannot be used for BIOS recovery at this time.

The file system supported by the recovery block is FAT (including FAT12, FAT16, and FAT32), which is installed on a bootable or non-bootable USB-attached device. However, the BIOS might need several minutes to locate the SUPER.ROM file if the media size becomes too large due to the huge volumes of folders and files stored in the device.

To perform UEFI BIOS recovery using a USB-attached device, follow the instructions below:

1. Using a different machine, copy the "Super.ROM" binary image file into the disc Root "\\" directory of a USB device or a writable CD/DVD.

 **Note 1:** If you cannot locate the "Super.ROM" file in your driver disk, visit our website at [www.supermicro.com](http://www.supermicro.com) to download the BIOS package. Extract the BIOS binary image into a USB flash device and rename it "Super.ROM" for the BIOS recovery use.

**Note 2:** Before recovering the main BIOS image, confirm that the "Super.ROM" binary image file you download is the same version or a close version meant for your motherboard.

2. Insert the USB device that contains the new BIOS image ("Super.ROM") into your USB port and reset the system until the following screen appears:



3. After locating the new BIOS binary image, the system will enter the BIOS Recovery menu as shown below:

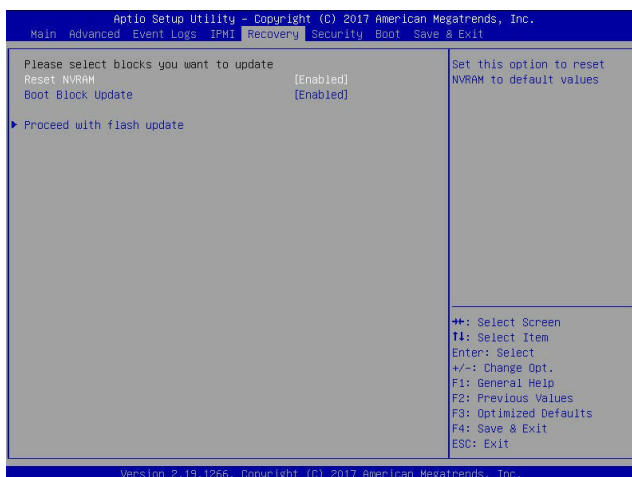

 **Note:** At this point, you may decide if you want to start the BIOS recovery. If you decide to proceed with BIOS recovery, follow the procedures below.

4. When the screen as shown above displays, use the arrow keys to select the item "Proceed with flash update" and press the <Enter> key. You will see the BIOS recovery progress as shown in the screen below:

 **Note:** Do not interrupt the BIOS flashing process until it has completed.

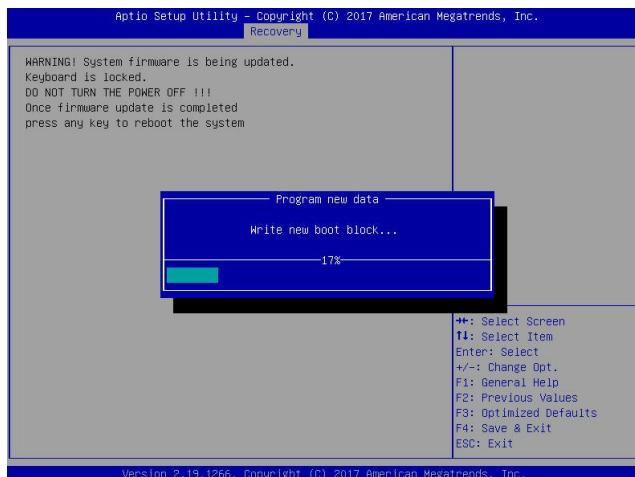

- After the BIOS recovery process is completed, press any key to reboot the system.

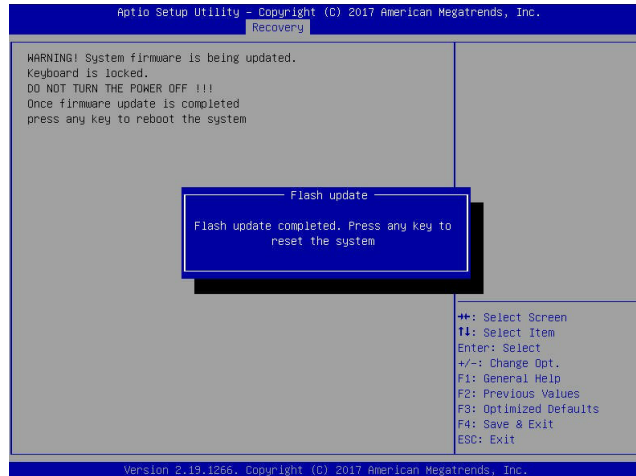

- Using a different system, extract the BIOS package into a USB flash drive.
- Press <Del> continuously during system boot to enter the BIOS Setup utility. From the top of the tool bar, select Boot to enter the submenu. From the submenu list, select Boot Option #1 as shown below. Then, set Boot Option #1 to [UEFI AP:UEFI: Built-in EFI Shell]. Press <F4> to save the settings and exit the BIOS Setup utility.

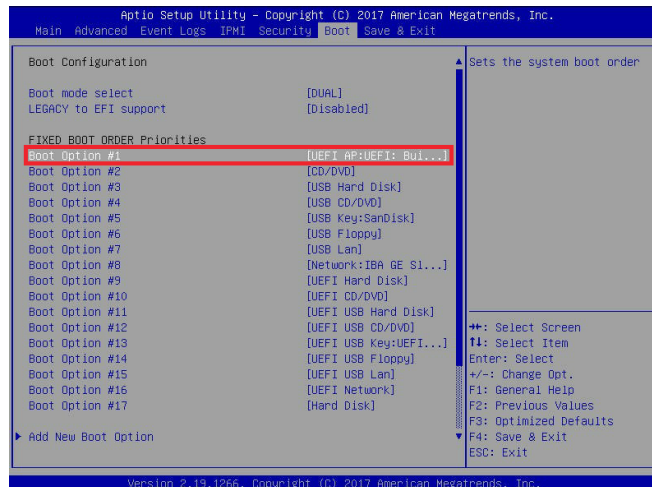

- When the UEFI Shell prompt appears, type `fs#` to change the device directory path. Go to the directory that contains the BIOS package you extracted earlier from Step 6. Enter `flash.nsh BIOSname.###` at the prompt to start the BIOS update process.

```

UEFI Interactive Shell v2.1
EDK II
UEFI v2.50 (American Megatrends, 0x0005000C)
Mapping Table
  FS0: Alias(s):HD(0):MB:BLK1:
        PciRoot(0x0)/Pci(0x14,0x0)/USB(0x11,0x0)/HD(1,MBR,0x3791072,0x800,0x1
DR9592)
  BLK0: Alias(s):
        PciRoot(0x0)/Pci(0x14,0x0)/USB(0x11,0x0)
Press F8 in 1 seconds to skip startup.nsh or any other key to continue.
Shell> fs#
FS0:\> cd AFUDOS
FS0:\AFUDOS> cd SNIPME2_03162017
FS0:\AFUDOS\SNIPME2_03162017> flash.nsh X110PU7_314

```



**Note:** Do not interrupt this process until the BIOS flashing is complete.

```

Done.
[ Access Cmos Port Ex ]
<Read>
Index 0x51: 0x10

Done.
*****
* Program BIOS and ME (including FDT) regions...
*****
| AMT Firmware Update Utility v5.09.01.1917
| Copyright (C)2017 American Megatrends Inc. All Rights Reserved.
|-----|
CPUID = 50652

Reading flash ..... done
- ME Data Size checking - ok
- FFS checksums ..... ok
- Check RomLayout ..... Ok
Erasing Boot Block ..... done
Updating Boot Block ..... done
Verifying Boot Block ..... done
_Erasing Main Block ..... 0x00132000 (0x)

```

- The screen above indicates that the BIOS update process is complete. When you see the screen above, unplug the AC power cable from the power supply, clear CMOS, and plug the AC power cable in the power supply again to power on the system.

```

Verifying MBR Block ..... done
- Update success for F8P
- Update success for IE -
- Successful Update Recovery Loader to OPRx11
- Successful Update MFSB11-
- Successful Update FTRx11-
- Successful Update MFS, IVB1 and IVB211
- Successful Update FLOG and UTOK11
- ME Entire Image update success !!
WARNING : system must power-off to have the changes take effect!
Moving FS0:\AFUDOS\SNIPME2_03162017\fdt\k64.efi -> FS0:\AFUDOS\SNIPME2_03162017\fdt\k64.efi
dt.smc
- [ok]
Moving FS0:\AFUDOS\SNIPME2_03162017\afuef1\k64.efi -> FS0:\AFUDOS\SNIPME2_03162017\afuef1.smc
- [ok]
*****
* Please ignore this 'Shell: Cannot read from file - Device Error'
* warning message due to it does not impact flashing process.
*****
Deleting .....
Delete successful.
FS0:\>

```

- Press `<Del>` continuously to enter the BIOS Setup utility.
- Press `<F3>` to load the default settings.
- After loading the default settings, press `<F4>` to save the settings and exit the BIOS Setup utility.