

Technics®

English
Français (Canada)
Español

EAH-AZ60M2 EAH-AZ40M2

Digital Wireless Stereo Earphones
Basic Owner's Manual

Écouteurs stéréo sans fil numériques
Manuel d'utilisation Fonctions de base
Auriculares estéreo inalámbricos digitales
Instrucciones básicas de funcionamiento

“Technics Audio Connect”

Android: Google Play



iOS: App Store



[EAH-AZ60M2]

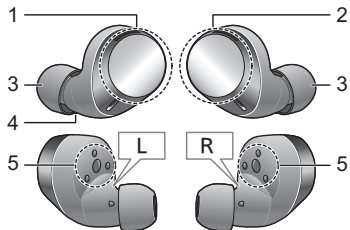

[EAH-AZ40M2]

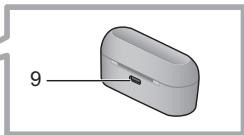
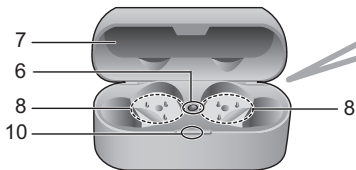
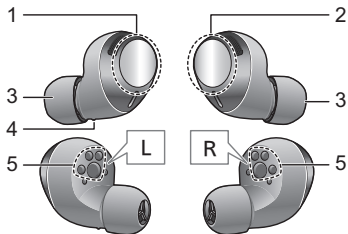

Part names

■ Main unit (earphones)

- 1 Touch sensor (L) (left)
- 2 Touch sensor (R) (right)
- 3 Earpieces
- 4 Raised dot indicating the L side
- 5 Charging terminals

■ Main unit (charging cradle)

- 6 Earphone charging LED
- 7 Certification information label
- 8 Terminal section
- 9 Charging terminal
- 10 Charging cradle LED

Behavior when charging with the USB charging cord with the earphones stored in the charging cradle

Charging cradle			Charging status
Outer LED	Inside LED	Lid	
—	Lights off	Open	Earphones batteries are full.
—	Red ^{*1}		Charging the earphones
Lights off	—	Close / Open	Charging cradle's batteries are full.
Green ^{*2}	—		Charging the charging cradle There is plenty of charge in the battery. 
Yellow ^{*2}	—		
Red ^{*2}	—		

*1 Blinking rapidly twice when the Earphone is set to charging cradle, and lights continuously during charging.

*2 Blinking rapidly when the lid is open / Blinking slowly when the lid is close.

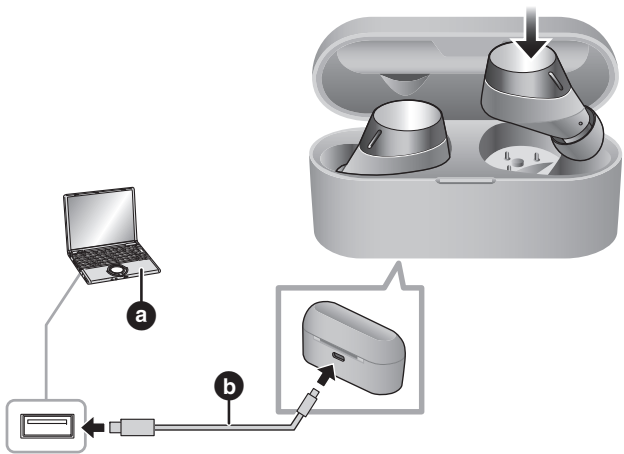

1 Charging

The rechargeable battery (installed in the unit) is not charged initially. Charge the battery before using the unit.

- Proper charging is not possible if there is dust or droplets of water on the charging terminal and the terminal sections of the earphones or charging cradle. Remove the dust or water droplets before charging.

1 Use the USB charging cord (supplied) (b) to connect the charging cradle to a 5.0 V power source (500 mA or higher) (a).

- The charging cradle outer LED lights (green, yellow or red) while the charging cradle is charging.

2 Put the earphones into the charging cradle.

- When the earphones are inserted, the charging cradle inside LED (red) flashes twice. If it is flashing, the earphones are not inserted correctly.

3 Confirm that the charging cradle inside LED (red) has flashed. (charging starts)

- While charging the cradle, the charging cradle outer LED (green, yellow or red) lights when the lid of the charging cradle is closed.
- Do not use any other USB charging cords except the supplied one. Doing so may cause malfunction.
- Qi charging is possible if using Qi charger (not included).

■ Charging time

Earphones	Approx. 2 hours
Charging cradle	Approx. 2.5 hours
Earphones with Charging cradle	[EAH-AZ60M2] Approx. 3.5 hours [EAH-AZ40M2] Approx. 3 hours

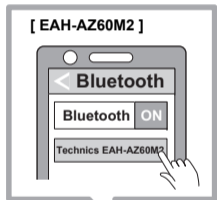

2 Pairing

Connecting by pairing (registering) your earphones with a Bluetooth® device

Using the “Technics Audio Connect” app (free of charge) makes connecting with Bluetooth® simple.

1 Take both earphones out of the charging cradle.

- When pairing your earphones for the first time:
The earphone will be stand-by for pairing.
- In the about 5 seconds from earphones take out from the charging cradle, touch and hold the sensor (L or R) for 7 seconds, the earphones will be entered the pairing mode.

2 Turn on the Bluetooth® device and enable the Bluetooth® function.

3 From the Bluetooth® menu of the Bluetooth® device, select device name “Technics EAH-AZ60M2” or “Technics EAH-AZ40M2”.

- When the earphone sounds signal of pairing, pairing has been completed and connection has been established.

4 Confirm by the Bluetooth® device that the earphones and the Bluetooth® device are connected.

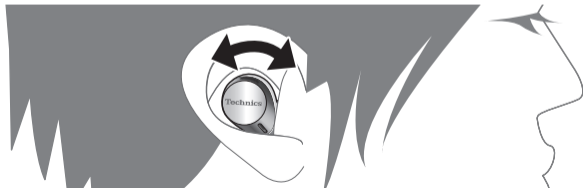
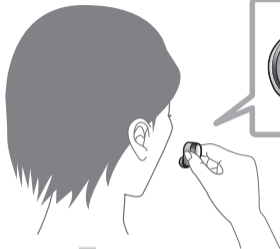

3 Fit the earphones

Fit the earphones correctly in order to get adequate noise cancelling effect and acoustics.

1 Check the orientation and L (left) and R (right) of the earphones.

2 Fit the earphones firmly as per the illustration.

- Confirm that the earphones will not fall from your ears after you have fitted them.
- The left earphone has a raised dot indicating the L side.
- If the earphones fall out easily, replace with earpieces (supplied) of a different size.

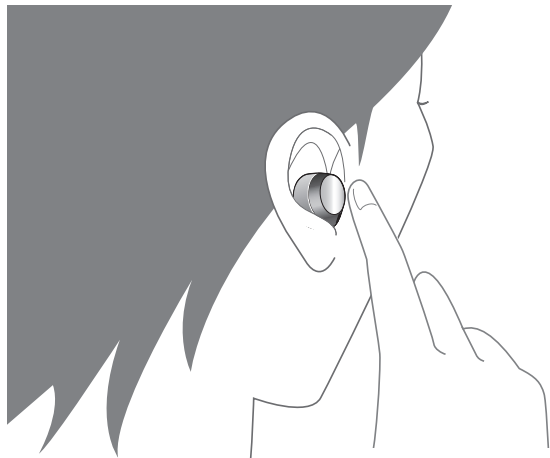

4 Operating with the Touch sensors

Operation	Touch sensor (L)	Touch sensor (R)
Touch once		▶/
Touch rapidly 2 times	Volume –	▶▶
Touch rapidly 3 times	Volume +	◀◀
Touch and hold for about 2 seconds	Start the voice assistant	Change control of external sounds* ¹

Operation	Touch sensor (L)	Touch sensor (R)
Touch once		Receive phone call
Touch rapidly 2 times	Volume –	Mute the voice of the call* ²
Touch rapidly 3 times	Volume +	Switch the level of noise from the other party
Touch and hold for about 2 seconds		Reject a phone call End a phone call

*¹ Noise cancelling ↔ Ambient sound

*² To cancel muting, touch the touch sensor (R) twice again while muting.

• You can customize the touch sensor operation in the app.

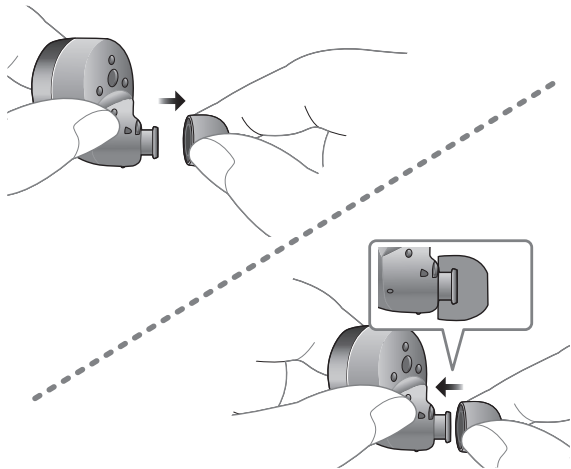

Tips for better sound quality (Changing earpieces)

The sound quality and the level of fit vary depending on the earpiece size. Choose earpieces with a size that snugly fits your left and right ears so they can be worn with comfort.

(The earpiece size that fits best may be different for the left and right ears.)

■ Remove the earpieces

Hold the earpiece with your fingertips and twist slightly to pull it out.

■ Attach the earpieces

Make sure the earpieces are fitted firmly into your ears and confirm that they are not at an angle.

Restoring to the factory settings

- 1 Put both earphones (L and R) into the charging cradle to charge the earphones fully.**
 - 2 Take the R side earphone out of the charging cradle.**
 - 3 While the earphone LED lights (blue) (about 5 seconds), touch and hold the touch sensor (R) for about 7 seconds.**
 - The earphone LED will light alternately in blue and red.
 - 4 Release your finger from the touch sensor (R).**
 - 5 Touch and hold the touch sensor (R) for about 10 seconds.**
 - The earphone LED (blue) blinks rapidly, and when the power turns off, the earphone returns to the factory settings.
 - 6 Do the same Steps 2 to 5 above for the L side earphone.**
- To re-pair the earphones with a Bluetooth® device, delete the registered information (device name: EAH-AZ60M2 or EAH-AZ40M2) on the device, then pair the earphones with the Bluetooth® device again.

Troubleshooting

Before requesting service, make the following checks. If you are in doubt about some of the check points, or if the remedies indicated in the chart do not solve the problem, refer to “Customer Services Directory” on the front page if you reside in the U.S.A., or refer to “CONTACT INFORMATION” on the front page if you reside in Canada, or consult your dealer for instructions.

Does not connect with the Bluetooth® device.

- Delete the registration information for this unit from the Bluetooth® menu, etc., of the Bluetooth® device, then pair again.

Cannot charge the unit.

- Make sure to charge in a room temperature between 10 °C and 35 °C (50 °F to 95 °F).
- Is the unit already fully charged? The charging cradle LEDs will turn off immediately if the unit is fully charged.
- Have the earphones been put into the charging cradle correctly?
- If the charging cradle LED (cyan) does not flash even after putting the earphones into the charging cradle, then there is no charge remaining in the charging cradle battery. First charge the charging cradle.
- Is the USB charging cord connected firmly to the USB terminal of the computer?

English

More detailed operating instructions are available in “Owner’s Manual (PDF format)”.

To read it, download it from the website. (→ below)

- Click the desired language.

Français

Un mode d’emploi plus détaillé est disponible dans “Manuel d’utilisation (format PDF)”.

Pour le lire, le télécharger depuis le site Web. (→ ci-dessous)

- Cliquer sur la langue souhaitée.

Español

Puede encontrar instrucciones de funcionamiento más detalladas en las “Instrucciones de funcionamiento (formato PDF)”.

Para leerlas, descárguelas del sitio web. (→ debajo)

- Haga clic en el idioma deseado.



https://www.technics.com/support/downloads/oi/EAH-AZ60M2_AZ40M2.html

[EAH-AZ60M2]

English

This unit complies with the “High Resolution Audio” standard of the Japan Audio Association.

- To enjoy wireless high-resolution quality (sound quality certified by the high-resolution wireless logo), use a playback device with the high-resolution wireless logo and set the Bluetooth® sound quality setting to sound quality priority mode / LDAC 990 kbps.
- In modes other than the above (connection priority mode, etc.), playback may not be possible with high resolution quality.

Français

Cet appareil est conforme avec la norme “High Resolution Audio” de Japan Audio Association.

- Pour bénéficier de la qualité haute résolution sans fil (qualité du son certifiée par le logo “high-resolution wireless”), utiliser un dispositif de lecture possédant le logo “high-resolution wireless” et régler le paramètre de la qualité du son Bluetooth® sur le mode priorité à la qualité du son / LDAC 990 kbps.
- Dans les modes autres que celui ci-dessus (mode priorité à la connectivité, etc.), la lecture pourrait être impossible en qualité haute résolution.

Español

Este aparato cumple con el estándar “High Resolution Audio” de la Japan Audio Association.

- Para disfrutar de calidad inalámbrica de alta resolución (calidad de sonido certificada por el logo inalámbrico de alta resolución), utilice un dispositivo de reproducción con el logo inalámbrico de alta resolución y establezca el ajuste de calidad de sonido Bluetooth® en el modo de prioridad de calidad de sonido / LDAC 990 kbps.
- En otros modos distintos al anterior (modo de prioridad de conexión, etc.), puede que no sea posible la reproducción con calidad de alta resolución.

Useful information (Only for Latin American countries)

Customer Service

Customer Service Directory

Obtain products information and operative assistant; localize the closer distributor or Service Center; buy spare parts and accessories by our Web Site to Latin America or calling our Contact Center:

COUNTRY	WEB SITE	CONTACT CENTER
Panama	www.panasonic.com/pa/soporte/	800-7262
Colombia	www.panasonic.com/co/soporte/	01-8000-947262
Ecuador	www.panasonic.com/pa/soporte/	1-800-726276
Costa Rica	www.panasonic.com/pa/soporte/	800-7262737
El Salvador	www.panasonic.com/pa/soporte/	800-7262
Guatemala	www.panasonic.com/pa/soporte/	1-801-811-7262
Uruguay	www.panasonic.com/pa/soporte/	0-800-7262
Paraguay	www.panasonic.com/pa/soporte/	Web Site
Chile	www.panasonic.com/cl/soporte/	800-390-602 022-797-5000
Peru	www.panasonic.com/pe/soporte/	0800-00726
Venezuela	www.panasonic.com/pa/soporte/	Web Site
Mexico	www.panasonic.com/mx/soporte/	800-847-7262 55-5000-1200
Argentina		0800-333-7262 0810-321-7262
Dominican Rep.	www.panasonic.com/pa/soporte/	809-200-8000

For Caribbean countries that speak English please enter this web site in order to find information of our products and operative assistant:
www.panasonic.com/caribbean

English

Expressions used in this document

- The product illustrations may differ from the actual product.
- Unless otherwise indicated, illustrations in these operating instructions are of EAH-AZ60M2.

Marks denoting model names

- Functionality differences between models are indicated with the model marks below.
EAH-AZ60M2: [EAH-AZ60M2] EAH-AZ40M2: [EAH-AZ40M2]

Français

Expressions utilisées dans ce document

- Les illustrations du produit peuvent différer du produit réel.
- Sauf indication contraire, les illustrations présentes dans ce manuel d'utilisation représentent le EAH-AZ60M2.

Symboles différenciant les noms de modèle

- Les différences de fonctionnalité entre les modèles sont indiquées par les symboles ci-dessous.
EAH-AZ60M2 : [EAH-AZ60M2] EAH-AZ40M2 : [EAH-AZ40M2]

Español

Expresiones utilizadas en este documento

- Las ilustraciones del producto pueden diferir del producto real.
- Salvo indicación contraria, las ilustraciones en estas instrucciones de funcionamiento corresponden al modelo EAH-AZ60M2.

Marcas que denotan nombres de modelos

- Las diferencias de funcionalidad entre los modelos se indican con las siguientes marcas de modelo.
EAH-AZ60M2 : [EAH-AZ60M2] EAH-AZ40M2 : [EAH-AZ40M2]



For US and Canada only
Pour les É.-U. et le Canada seulement

English

A lithium ion battery that is recyclable powers the product you have purchased. Please call 1-800-8-BATTERY for information on how to recycle this battery.

Français

L'appareil que vous vous êtes procuré est alimenté par une batterie au lithium-ion. Pour des renseignements sur le recyclage de la batterie, veuillez composer le 1-800-8-BATTERY.

Español

Una batería de litio reciclable alimenta el producto que ha comprado. Llame al número 1-800-8-BATTERY para más información sobre cómo reciclar esta batería.

English

Thank you for purchasing this product.

Please read these instructions carefully before using this product, and save this manual for future use.

Accessories

Please check and identify the supplied accessories.

To order accessories, contact the dealer from whom you have made your purchase.

1 x USB charging cord

[EAH-AZ60M2]

1 x Earpieces set (2 each of sizes XS1, XS2, S1, S2, M, L, and XL) (M size fitted to the earphones)

[EAH-AZ40M2]

1 x Earpieces set (2 each of sizes XS, S, M, and L) (M size fitted to the earphones)

Only for U.S.A.: To order accessories, refer to "Limited Warranty".

IMPORTANT SAFETY INSTRUCTIONS

Read these operating instructions carefully before using the unit. Follow the safety instructions on the unit and the applicable safety instructions listed below. Keep these operating instructions handy for future reference.

- 1 Do not use this apparatus near water.
- 2 Protect the power cord from being walked on or pinched particularly at plugs, convenience receptacles, and the point where they exit from the apparatus.
- 3 Unplug this apparatus during lightning storms or when unused for long periods of time.
- 4 Refer all servicing to qualified service personnel. Servicing is required when the apparatus has been damaged in any way, such as power-supply cord or plug is damaged, liquid has been spilled or objects have fallen into the apparatus, the apparatus has been exposed to rain or moisture, does not operate normally, or has been dropped.
- 5 Clean only with dry cloth.

Safety precautions**THE FOLLOWING APPLIES ONLY IN THE U.S.A. AND CANADA.**

This device complies with Part 15 of FCC Rules and Innovation, Science and Economic Development Canada's licence-exempt RSS(s). Operation is subject to the following two conditions:

- (1) this device may not cause interference, and
- (2) this device must accept any interference, including interference that may cause undesired operation.

[EAH-AZ60M2]

FCC ID: ACJ-EAH-AZ60M2

Model: EAH-AZ60M2

IC: 216A-EAH-AZ60M2

[EAH-AZ40M2]

FCC ID: ACJ-EAH-AZ40M2

Model: EAH-AZ40M2

IC: 216A-EAH-AZ40M2

This transmitter must not be co-located or operated in conjunction with any other antenna or transmitter.

(For the U.S.A. only)

This equipment complies with FCC radiation exposure limits set forth for an uncontrolled environment and meets the FCC radio frequency (RF) Exposure Guidelines as this equipment has very low levels of RF energy.

(For Canada only)

EAH-AZ60M2 and EAH-AZ40M2 have been tested and found to comply with ISED radiation exposure limits set forth for an uncontrolled environment and meet RSS-102 of the ISED radio frequency (RF) Exposure rules.

THE FOLLOWING APPLIES ONLY IN THE U.S.A.**FCC Note:**

This equipment has been tested and found to comply with the limits for a Class B digital device, pursuant to Part 15 of the FCC Rules. These limits are designed to provide reasonable protection against harmful interference in a residential installation. This equipment generates, uses, and can radiate radio frequency energy and, if not installed and used in accordance with the instructions, may cause harmful interference to radio communications.

However, there is no guarantee that interference will not occur in a particular installation. If this equipment does cause harmful interference to radio or television reception, which can be determined by turning the equipment off and on, the user is encouraged to try to correct the interference by one or more of the following measures:

- Reorient or relocate the receiving antenna.
- Increase the separation between the equipment and receiver.
- Connect the equipment into an outlet on a circuit different from that to which the receiver is connected.
- Consult the dealer or an experienced radio/TV technician for help.

FCC Caution:

Any unauthorized changes or modifications to this equipment would void the user's authority to operate this device.

This device complies with Part 15 of the FCC Rules. Operation is subject to the following two conditions:

- (1) This device may not cause harmful interference, and
- (2) this device must accept any interference received, including interference that may cause undesired operation.

Supplier's Declaration of Conformity

[EAH-AZ60M2]

Trade Name: Technics

Model No.: EAH-AZ60M2

Responsible Party: Panasonic Corporation of North America
Two Riverfront Plaza, Newark, NJ 07102-5490Support Contact: <http://shop.panasonic.com/support>

[EAH-AZ40M2]

Trade Name: Technics

Model No.: EAH-AZ40M2

THE FOLLOWING APPLIES ONLY IN CANADA.

CAN ICES-3(B)/NMB-3(B)

The serial number of this product can be found on the bottom of the charging cradle.

Please note them in the space provided below and keep for future reference.

MODEL NUMBER _____

SERIAL NUMBER _____

User memo:

DATE OF PURCHASE _____

DEALER NAME _____

DEALER ADDRESS _____

TELEPHONE NUMBER _____

■ Unit**WARNING:**

To reduce the risk of fire, electric shock or product damage,

- Do not expose this unit to rain, moisture, dripping or splashing.
- Use only manufacturer's recommended accessories.
- Do not remove covers.
- Do not repair this unit by yourself. Refer servicing to qualified service personnel.

Avoid the use in the following conditions

- High or low extreme temperatures during use, storage or transportation.
- Disposal of a battery into fire or a hot oven, or mechanically crushing or cutting of a battery, that can result in an explosion.
- Extremely high temperature and/or extremely low air pressure that can result in an explosion or the leakage of flammable liquid or gas.

- Do not place this unit near a heat source.
- Do not listen with this unit at high volume in places where you need to hear sounds from the surrounding environment for safety, such as at railroad crossings, and construction sites.
- Keep this unit away from something susceptible to the magnetism. Such devices as a clock may not operate correctly.
- Be aware that this unit (earphones) may get warm while charging or immediately after charging. Depending on your constitution and health status, putting the earphones on may trigger adverse reactions such as skin redness, itching, and rash if the earphones have just been taken out of the charging cradle and are still warm.

■ Built-in battery

- Do not heat or expose to flame.
- Do not leave the unit in a car exposed to direct sunlight for a long period of time with doors and windows closed.

■ Earphones/Earpieces

- Keep the earphones and the earpieces out of reach of children and pets to prevent swallowing. After use, put them in the charging cradle and close the lid for storage.
- Securely attach the earpieces. If they are left in the ears after coming off, injury or sickness may be caused.

■ Allergies

- Discontinue use if you experience discomfort with the earphones or any other parts that directly contact your skin.
- Continued use may cause rashes or other allergic reactions.

■ Precautions for listening with the Earphones

- Excessive sound pressure from earphones and headphones can cause hearing loss.
- Do not use your earphones at a high volume. Hearing experts advise against continuous extended play.
- If you experience a ringing in your ears, reduce volume or discontinue use.
- Do not use while operating a motorized vehicle. It may create a traffic hazard and is illegal in many areas.
- You should use extreme caution or temporarily discontinue use in potentially hazardous situations.

This unit may receive radio interference caused by mobile telephones during use. If such interference occurs, please increase separation between this unit and the mobile telephone.

Use only the supplied USB charging cord when connecting to a computer.

The symbols on this product (including the accessories) represent the following:  DC

Declaration of Conformity (DoC)

Hereby, "Panasonic Entertainment & Communication Co., Ltd." declares that this product is in compliance with the essential requirements and other relevant provisions of Directive 2014/53/EU. Customers can download a copy of the original DoC to our RE products from our DoC server: <http://www.ptc.panasonic.eu>

Contact to Authorized Representative: Panasonic Marketing Europe GmbH,
Panasonic Testing Centre, Winsbergring 15, 22525 Hamburg, Germany

Type of wireless	Frequency band	Maximum power (dBm e.i.r.p)
Bluetooth®	2,402 - 2,480 MHz	6 dBm

Declaration of Conformity for Radio Equipment in UK

Panasonic Entertainment & Communication Co., Ltd. declares that the radio equipment type (Model Numbers are referred in the Operating Instructions) is in compliance with The Radio Equipment Regulations SI 2017 No.1206. The full text of the UK declaration of conformity is available at the following internet address: <https://www.ptc.panasonic.eu/compliance-documents>

Contact in the UK : Panasonic Testing Centre on behalf of Panasonic UK,
a branch of Panasonic Marketing Europe GmbH (Importer),
Maxis 2, Western Road, Bracknell, Berkshire, RG12 1RT

Specifications

■ General

	EAH-AZ60M2	EAH-AZ40M2
Power supply (Charging cradle)	DC 5 V, 500 mA	
Internal Battery	Earphones: 3.7 V, Lithium polymer 85 mAh Charging cradle: 3.7 V, Lithium polymer 650 mAh	Earphones: 3.7 V, Lithium polymer 55 mAh Charging cradle: 3.7 V, Lithium polymer 450 mAh
Operating time*1 (Earphones)	Approx. 7.0 hours (Noise cancelling: ON, AAC) Approx. 5.5 hours (Noise cancelling: ON, SBC) Approx. 4.5 hours (Noise cancelling: ON, LDAC)	Approx. 7.5 hours (AAC) Approx. 5.5 hours (SBC)
Operating time*1 (Earphones + Charging cradle)	Approx. 24 hours (Noise cancelling: ON, AAC) Approx. 22 hours (Noise cancelling: ON, SBC) Approx. 16 hours (Noise cancelling: ON, LDAC)	Approx. 25 hours (AAC) Approx. 19 hours (SBC)
Charging time*2 (25 °C (77 °F))	Earphones: Approx. 2.0 hours Charging cradle: Approx. 2.5 hours Earphones with Charging cradle: Approx. 3.5 hours	Earphones: Approx. 2.0 hours Charging cradle: Approx. 2.5 hours Earphones with Charging cradle: Approx. 3 hours
Charging temperature range	10 °C to 35 °C (50 °F to 95 °F)	
Operating temperature range	0 °C to 40 °C (32 °F to 104 °F)	
Operating humidity range	35 %RH to 80 %RH (no condensation)	
Mass (Weight)	Earphone: Approx. 7 g (0.25 oz) (one side only: L and R are the same) Charging cradle: Approx. 45 g (1.6 oz)	Earphone: Approx. 5 g (0.18 oz) (one side only: L and R are the same) Charging cradle: Approx. 30 g (1.1 oz)

■ Bluetooth® section

Frequency band	2402 MHz to 2480 MHz	
Supported profiles	A2DP, AVRCP, HSP, HFP	
Supported codec	SBC, AAC, LDAC	SBC, AAC

■ Charging cradle section

Charging terminal	USB Type-C Shape
--------------------------	------------------

■ Water resistant

Water resistant	IPX4 equivalent (earphones only)
------------------------	----------------------------------

*1 It may be shorter depending on the operating conditions.

*2 The time required to charge the batteries from empty to full.

• Specifications are subject to change without notice.

The Bluetooth® word mark and logos are registered trademarks owned by Bluetooth SIG, Inc. and any use of such marks by Panasonic Corporation is under license.

Other trademarks and trade names are those of their respective owners.

Apple and the Apple logo are trademarks of Apple Inc., registered in the U.S. and other countries. App Store is a service mark of Apple Inc.

Google, Android, Google Play, and other related marks and logos are trademarks of Google LLC.

[EAH-AZ60M2] LDAC and LDAC logo are trademarks of Sony Corporation.

QR Code is a registered trademark of DENSO WAVE INCORPORATED.

Other system names and product names appearing in this document are in general the registered trademarks or trademarks of the respective developer companies.

Note that the ™ mark and ® mark do not appear in this document.

This product incorporates the open source software other than the software licensed under the GPL V2.0 and/or LGPL V2.1. The software categorized as above are distributed in the hope that it will be useful, but WITHOUT ANY WARRANTY, without even the implied warranty of MERCHANTABILITY or FITNESS FOR A PARTICULAR PURPOSE. Please refer to the detailed terms and conditions thereof shown at the following web page.

<https://panasonic.jp/support/global/cs/audio/download/index.html>

About Bluetooth®

■ Restrictions of use

- Wireless transmission and/or usage with all Bluetooth® equipped devices is not guaranteed.
- Depending on the specifications and settings of a device, it can fail to connect or some operations can be different.

When disposing of the product

The built-in batteries are a valuable recyclable resource. When disposing of this unit, rather than disposing of in general waste (non-combustible garbage), follow the local national laws and take to the appropriate collection point. Contact your local government organization if you are unsure of your local collection point. Refer to the specifications in this document for information about the batteries.

English

Install the app "Technics Audio Connect"

By creating a Bluetooth® connection with a smartphone on which the "Technics Audio Connect" app (free of charge) is installed, you can enjoy a wide variety of functions, such as different customized settings and software updates for this unit.

- For information, refer to "Owner's Manual (PDF format)".

Français

Installer l'application "Technics Audio Connect"

En établissant une connexion Bluetooth® avec un téléphone intelligent sur lequel l'application "Technics Audio Connect" (gratuite) est installée, il est possible de bénéficier d'une grande variété de fonctions, comme divers réglages personnalisés et des mises à jour logicielles pour cet appareil.

- Pour plus de détails, consulter le "Manuel d'utilisation (format PDF)".

Español

Instale la aplicación "Technics Audio Connect"

Si crea una conexión Bluetooth® con un teléfono inteligente en el que está instalada la aplicación "Technics Audio Connect" (gratuita), podrá disfrutar de una amplia variedad de funciones, tales como diferentes ajustes personalizados y actualizaciones de software para este aparato.

- Para obtener más información, consulte "Instrucciones de funcionamiento (formato PDF)".

Register online at <http://shop.panasonic.com/support>
(U.S. customers only/Pour les É.-U. seulement)

If you have any questions, visit:

In the U.S.A.: <http://shop.panasonic.com/support>
In Canada: www.panasonic.ca/english/support

Pour toute assistance supplémentaire, visitez :
www.panasonic.ca/french/support

[EAH-AZ60M2]

LDAC

For the United Kingdom and Ireland customers

Sales and Support Information

Customer Communications Centre

- For customers within the UK: 0333 222 8777
- For customers within Ireland: 01 447 5229
- Monday–Friday 9:00 am–5:00 pm (Excluding public holidays).
- For further support on your product, please visit our website:
www.technics.com/uk/

English

Panasonic Entertainment & Communication Co., Ltd.
1-10-12 Yagumo-higashi-machi, Moriguchi City, Osaka 570-0021, Japan
Authorized Representative in EU;
Panasonic Marketing Europe GmbH
Panasonic Testing Centre,
Winsbergring 15, 22525 Hamburg, Germany

Español

Panasonic Entertainment & Communication Co., Ltd.
1-10-12 Yagumo-higashi-machi, Ciudad de Moriguchi, Osaka 570-0021, Japón
Representante Autorizado para la UE;
Panasonic Marketing Europe GmbH
Panasonic Testing Centre,
Winsbergring 15, 22525 Hamburgo, Alemania

Panasonic Corporation of North America
Two Riverfront Plaza, Newark,
NJ 07102-5490
<http://shop.panasonic.com>

Panasonic Canada Inc.
5770 Ambler Drive,
Mississauga, Ontario L4W 2T3
www.panasonic.com

(En) (Cf) (Sp)

EU



Panasonic Entertainment & Communication Co., Ltd.
<http://www.panasonic.com>

© Panasonic Entertainment & Communication 2022

Printed in Malaysia/Imprimé en Malaisie/Impreso en Malasia PNQW****ZA
P*****

