

Tefal®

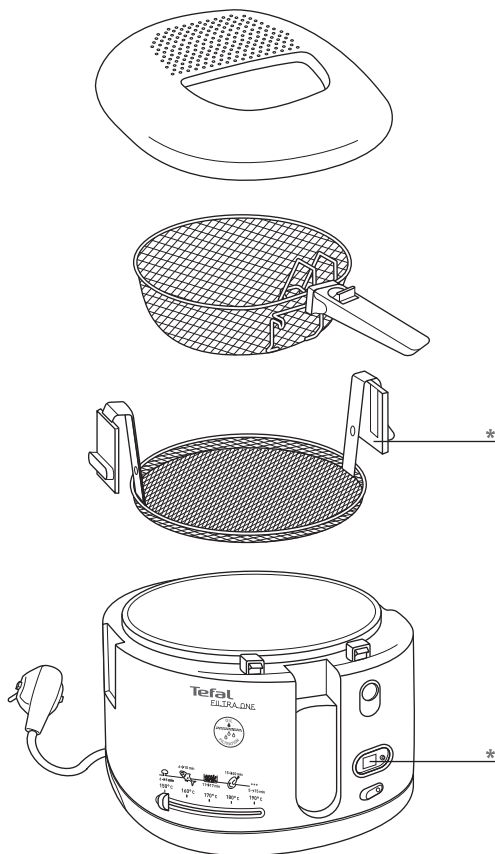

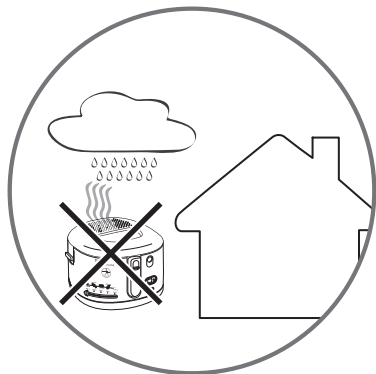

* Selon modèle • Afhankelijk van het model • Je nach Modell • Depending on model • Secondo i modelli • Según modelo • Consoante o modelo • ανάλογα με το μοντέλο • Modelle göre • Áfhængig af model • Beroende på modell • Avhenger av modell • Mallista riippuen • Ovisno o modelu • Zavisno od modela • в зависимости от модели • Odvisno od modela • W zależności od typu • Podle modelu • V závislosti od modelu • Modelltól függően • В зависимости от модели • Залежно від моделі • Ovisno o modelu • Sõltuvalt mudelist • Atbilstoši modelim • Pagal modelį • بر حسب الموديل • بحسب مدل



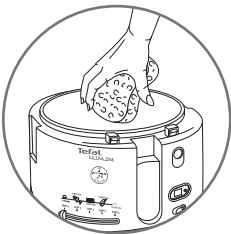
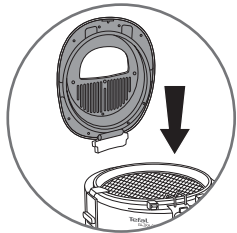
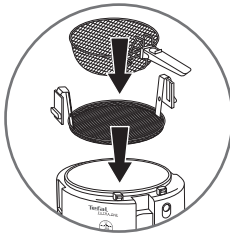
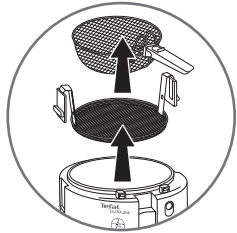
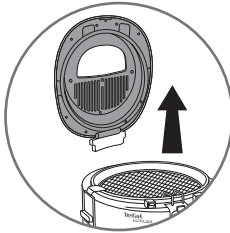
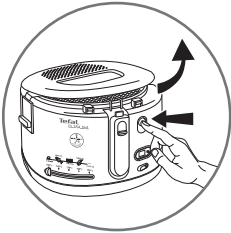



Min. 1,9 l
Max. 2,1 l

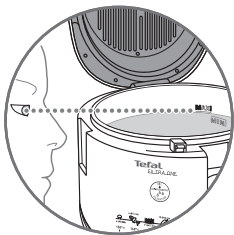
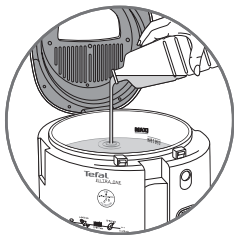

Min. 1660 g
Max. 1910 g

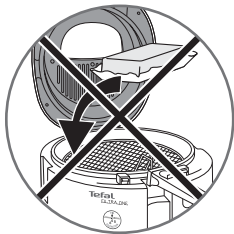
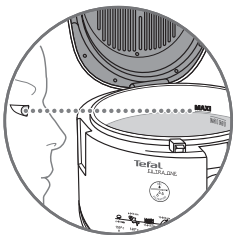
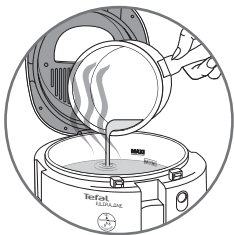
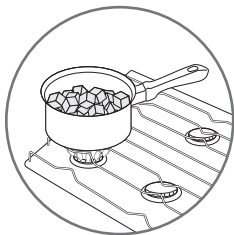



Max. 1200 g

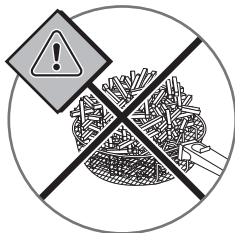
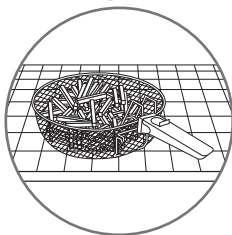
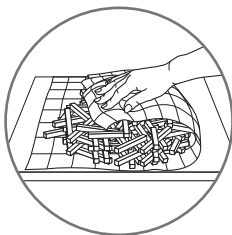

Max. 900 g

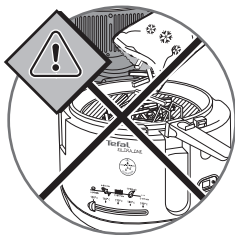
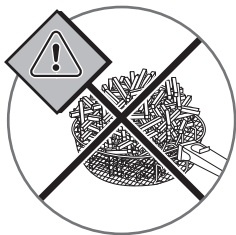
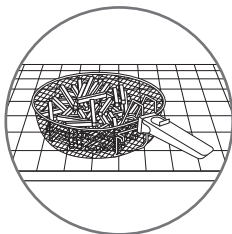
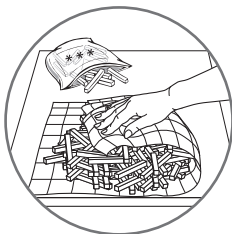

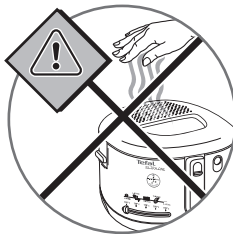
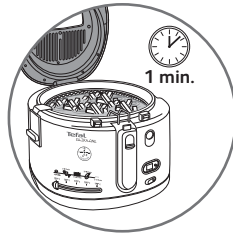
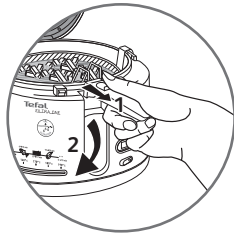
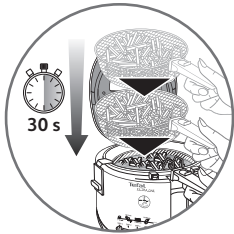
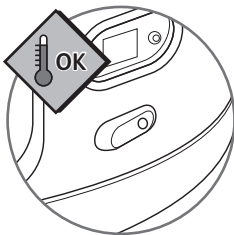
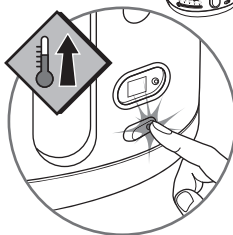
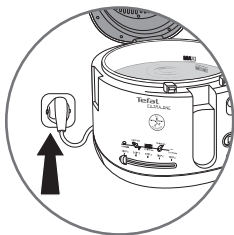

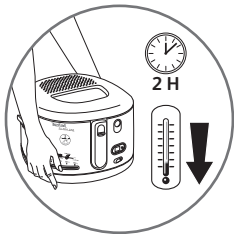
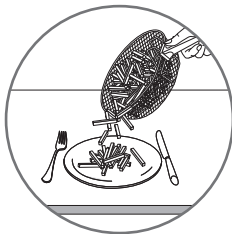
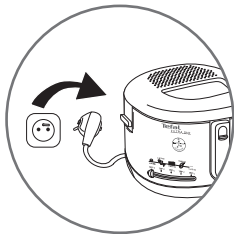
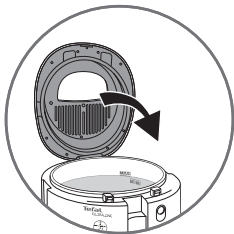
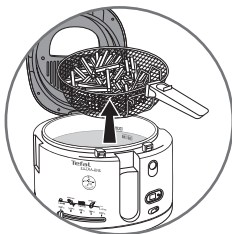
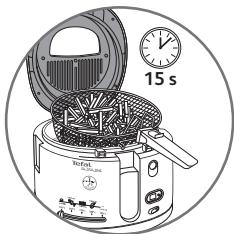
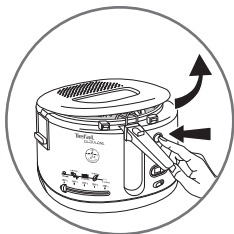
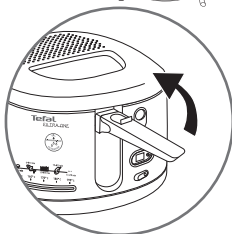
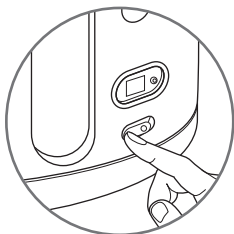
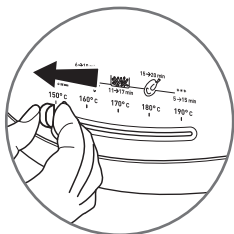

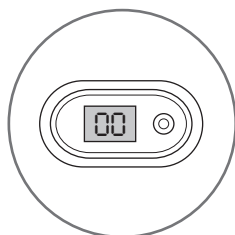
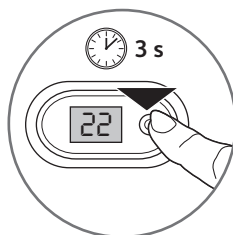
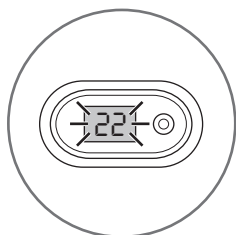
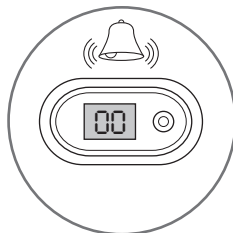
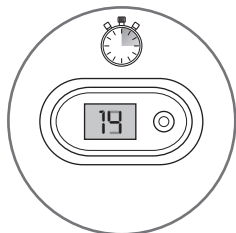
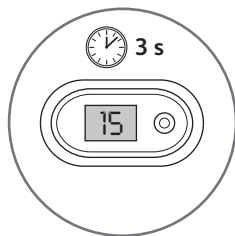
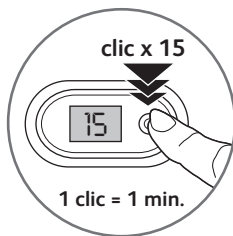
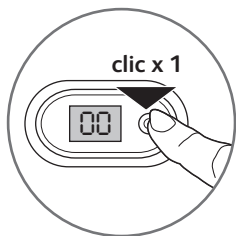















* Selon modèle • Afhankelijk van het model • Je nach Modell • Depending on model • Secondo i modelli • Según modelo • Consoante o modelo • ανάλογα με το μοντέλο • Modelle göre • Áfhængig af model • Beroende på modell • Avhenger av modell • Mallista riippuen • Ovisno o modelu • Zavisno od modela • в зависимости от модели • Odvisno od modela • W zależności od typu • Podle modelu • V závislosti od modelu • Modelltól függően • В зависимости от модели • Залежно від моделі • Ovisno o modelu • Sõltuvalt mudelist • Atbilstoši modelim • Pagal modelį • بر حسب مدل • حسب الموديل



	Nb			
		600 g	170°C	+/- 11-13 min
		1000 g	170°C	+/- 15-17 min
	8		180°C	+/- 13-15 min
	3		170°C	+/- 6-8 min
		200 g	150°C	+/- 8-10 min
	7-8		180°C	+/- 8-10 min
	6		180°C	+/- 6-8 min
* * *	Nb			
		750 g	190°C	+/- 8-10 min
		450 g	170°C	+/- 8-10 min
	10		190°C	+/- 6-8 min
	8		190°C	+/- 13-15 min
		900 g	190°C	+/- 7-8 min
		300 g	190°C	+/- 5-6 min

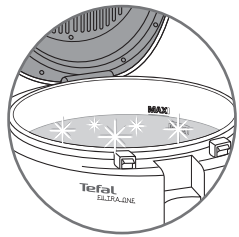
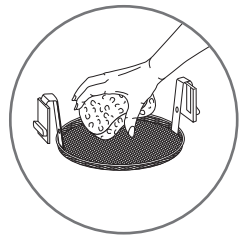
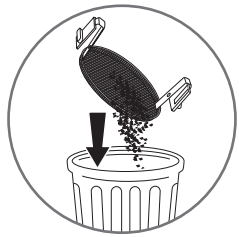

* Selon modèle • Afhankelijk van het model • Je nach Modell • Depending on model • Secondo i modelli • Según modelo • Consoante o modelo • ανάλογα με το μοντέλο • Modele göre • Áfhængig af model • Beroende på modell • Avhenger av modell • Mallista riippuen • Ovisno o modelu • Zavisno od modela • в зависимости от модели • Odvisno od modela • W zależności od typu • Podle modelu • V závislosti od modelu • Modelltól függően • В зависимости от модели • Залежно від моделі • Ovisno o modelu • Sõltuvalt mudelist • Atbilstoši modelim • Pagal modelį • بر حسب المدل • بحسب الموديل

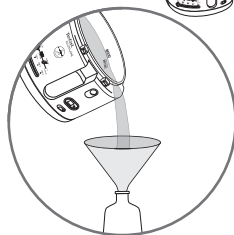
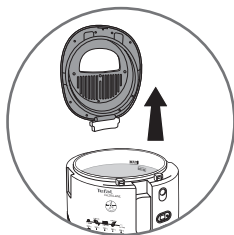

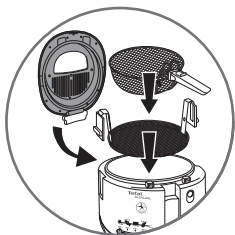
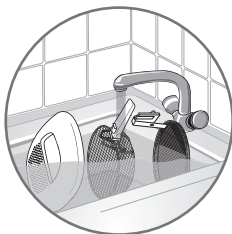
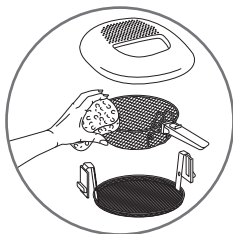
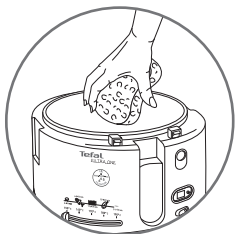
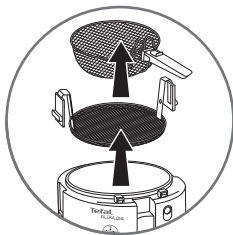
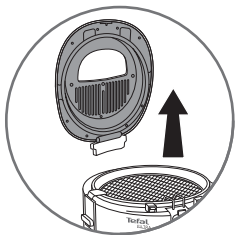



 : www.tefal.com

			
ALGERIA	GROUPE SEB EXPORT Chemin du Petit Bois, Les 4M 69130 ECULLY - FRANCE	213-41 28 18 53	1 year
ARGENTINA	GROUPE SEB ARGENTINA S.A. Billinghurst 1833 3º C1425DTK Capital Federal Buenos Aires	0800-122-2732	2 años
ՀԱՅԱՍՏԱՆ ARMENIA	«Գրուպպա ՍԵԲ-Վոստոկ»ՓԲԸ, 119180 Մոսկվա, Ռուսաստան Ստարոմոնետնի կրք., ս.14, շ.2	(010) 55-76-07	2 տարի/ years
AUSTRALIA	GROUPE SEB AUSTRALIA PO Box 7535, Silverwater NSW 2128	02 97487944	1 year
ÖSTERREICH	SEB ÖSTERREICH HmbH Campus 21 - Businesspark Wien Süd Liebermannstr. A02 702 2345 Brunn am Gebirge	01 866 70 299 00	2 Jahre
BELGIQUE / BELGIE	GROUPE SEB BELGIUM SA NV 25 avenue de l'Espérance - ZI 6220 Fleurus	32 70 23 31 59	2 ans / years
БЕЛАРУСЬ / BELARUS	ЗАО «Группа СЕБ-Восток», 119180 Москва, Россия Старомонетный пер. д.14 стр.2	017 2239290	2 года/ years
BOSNA I HERCEGOVINA	SEB Développement Predstavništvo u BiH Vrazova 8/II 71000 Sarajevo	Info-linija za potrošače 033 551 220	2 godine
BRASIL	GRUPO SEB DO BRASIL PRODUTOS DOMESTICOS LTDA Avenida Arno, 146 Mooca 03108-900 São Paulo SP	0800-119933	1 ano
БЪЛГАРИЯ/ BULGARIA	ГРУП СЕБ БЪЛГАРИЯ ЕООД Ул. Борово 52 Г, ет. 1, офис 1, 1680 София	0700 10 330	2 ГОДИНИ
CANADA	GROUPE SEB CANADA 345 Passmore Avenue Toronto, ON M1V 3N8	1-800-418-3325	1 year
CHILE	GROUPE SEB CHILE Comercial Ltda Avda. Nueva Los Leones 0252 Providencia, Santiago	+56 2 232 77 22	2 años
COLOMBIA	GROUPE SEB COLOMBIA Apartado Aereo 172, Kilometro 1 Via Zipaquira Cajica Cundinamarca	18000919288	2 años
HRVATSKA Croatia	SEB Développement S.A.S. Vodnjanska 26 10000 Zagreb	01 30 15 294	2 godine
ČESKÁ REPUBLIK / CZECH REPUBLIC	GROUPE SEB ČR spol. s r. o. Jankovcova 1569/2c 170 00 Praha 7	731 010 111	2 roky
DANMARK	GROUPE SEB NORDIC AS Tempovej 27 2750 Ballerup	44 663 155	2 år
DEUTSCHLAND	GROUPE SEB DEUTSCHLAND GmbH / KRUPS GmbH Herrrainweg 5 63067 Offenbach	0212 387 400	2 Jahre

 : www.tefal.com

			
EESTI/ ESTONIA	GRUPE SEB POLSKA SP Z O.O. ul. Ostrobramska 79 04-175 Warszawa	5 800 3777	2 aastat
SUOMI / FINLAND	Groupe SEB Finland Kutojantie 7 02630 Espoo	09 622 94 20	2 Vuotta
FRANCE Inclus Martinique, Guadeloupe, Réunion & St. Martin	GRUPE SEB France SAS Place Ambroise Courtois 69355 Lyon Cedex 08	09 74 50 47 74	1 an
GREECE / ΕΛΛΑΔΑ	SEB GROUPE ΕΛΛΑΔΟΣ Α.Ε. Οδός Φραγκοκκλησιάς 7 Τ.Κ. 151 25 Παράδεισος Αμαρουσίου	2106371251	2 χρόνια
HONG KONG	SEB ASIA Ltd. Room 901, 9/F, North Block, Skyway House 3 Sham Mong Road, Tai Kok Tsui, Kowloon	852 8130 8998	1 year
MAGYARORSZÁG/ Hungary	GRUPE SEB CENTRAL-EUROPE Kft. Tavíro köz 4 2040 Budaörs	(1) 8018434	2 év
INDONESIA	Groupe SEB Indonesia (Representative office) Sudirman Plaza, Plaza Marein 8th Floor JL Jendral Sudirman Kav 76-78, Jakarta 12910, Indonesia	+62 21 5793 6881	1 year
ITALIA	GRUPE SEB ITALIA S.p.A. Via Montefeltro, 4 20156 Milano	199207354	2 anni
JAPAN	GRUPE SEB JAPAN Co. Ltd. 1F Takanawa Muse Building, 3-14-13, Higashi Gotanda, Shinagawa-Ku, Tokyo 141-0022	0570-077772	1 year
ҚАЗАҚСТАН KAZAKHSTAN	«Группа СЕБ-Восток» ЖАҚ, 119180 Мәскеу, Ресей Старомонетный тұйық көш, 14-үй, 2-құрылыс	727 378 39 39	2 жыл / years
KOREA	(유)그림 세브 코리아 서울시 종로구 서린동 88 서린빌딩 3층 110-790	1588-1588	1 year
LATVJA / LATVIA	GRUPE SEB POLSKA SP Z O.O. ul. Ostrobramska 79 04-175 Warszawa	6 716 2007	2 gadi
LIETUVA/ LITHUANIA	GRUPE SEB POLSKA SP Z O.O. ul. Ostrobramska 79 04-175 Warszawa	6 470 8888	2 metai
MACEDONIA	Groupe SEB Bulgaria EOOD Office 1, floor 1, 52G Borovo St., 1680 Sofia - Bulgaria ГРУП СЕБ БЪЛГАРИЯ ДООЕЛ Ул. Борово 52 Г, сп. 1, офис 1, 1680 София, България	(0)2 20 50 022	2 години / years
MALAYSIA	GRUPE SEB MALAYSIA SDN. BHD Lot No.C/3A/001 & 002, Block C, Kelana Sq. No.17, Jalan SS7/26, 47301 Kelana Jaya Petaling Jaya, Selangor	65 6550 8900	1 year
MEXICO	G.S.E.B. MEXICANA, S.A. de C.V. Goldsmith 38 Desp. 401, Col. Polanco Delegacion Miguel Hidalgo 11 560 Mexico D.F.	(01800) 112 8325	1 años

			
MOLDOVA	ТОВ «Грун СЕБ Україна» Вул. Драгоманова 31 Б, офіс 1 02068 Київ, Україна	(22) 929249	2 ani / years
NEDERLAND	GROUPE SEB NEDERLAND BV Generatorstraat 6 3903 LJ Veenendaal	0318 58 24 24	2 jaar
NEW ZEALAND	GROUPE SEB NEW ZEALAND Unit E, Building 3, 195 Main Highway, Ellerslie, Auckland	0800 700 711	1 year
NORGE	GROUPE SEB NORDIC AS Tempovej 27 2750 Ballerup DANMARK	815 09 567	2 år
PERU	GROUPE SEB COLOMBIA Av. Camino Real N° 111 of. 805 B San Isidro - Lima - Perú	+511 441 4455	1 años
POLSKA/ POLAND	GROUPE SEB POLSKA SP Z O.O. ul. Ostobramska 79 04-175 Warszawa	0801 300 422 koszt jak za połączenie lokalne	2 lata
PORTUGAL	GROUPE SEB IBÉRICA SA Urb. da Matinha Rua Projectada à Rua 3 Bloco1 - 3° B/D 1900 - 796 Lisboa	808 284 735	2 anos
REPUBLIC OF IRELAND	GROUPE SEB IRELAND Unit B3 Aerodrome Business Park, College Road, Rathcoole, Co. Dublin	01 677 4003	1 year
ROMÂNIA/ ROMANIA	GROUPE SEB ROMÂNIA Str. Daniel Constantin nr. 8 010632 Bucuresti	0 21 316 87 84	2 ani
РОССИЯ/ RUSSIA	ЗАО «Группа СЕБ-Восток», 119180 Москва, Россия Старомонетный пер. д.14 стр.2	495 213 32 37	2 года/ years
SRBIJA Serbia	SEB Developpement Antifasističke borbe 17/13 11070 Novi Beograd	060 0 732 000	2 godine
SINGAPORE	GROUPE SEB SINGAPORE Pty Ltd. 59 Jalan Pemimpin, #04-01/02 L&Y Building Singapore 577218	65 6550 8900	1 year
SLOVENSKO/ SLOVAKIA	GROUPE SEB SLOVENSKO s.r.o. Rybničná 40 831 07 Bratislava	233 595 224	2 roky
SLOVENIJA	SEB d.o.o Gregorčičeva ulica 6 2000 MARIBOR	02 234 94 90	2 leti
ESPAÑA	GROUPE SEB IBÉRICA S.A. Almogüvers, 119-123. Complejo Ecurban 08018 Barcelona	0902 31 25 00	2 años
SVERIGE	TEFAL SVERIGE SUBSIDIARY OF GROUP SEB NORDIC Truckvägen 14 A, 194 52 Upplands Väsby	08 594 213 30	2 år
SUISSE SCHWEIZ	GROUPE SEB SCHWEIZ GmbH Thurgauerstrasse 105 8152 Glattbrugg	044 837 18 40	2 ans / Jahre
TAIWAN	SEB ASIA Ltd. Taipei International Building, Suite B2, 6F-1, No. 216, Tun Hwa South Road, Sec. 2 Da-an District Taipei 106, R.O.C.	886-2-27333716	1 year

 : www.tefal.com

			
THAILAND	GROUPE SEB THAILAND 2034/66 Italthai Tower, 14th Floor, n° 14-02, New Phetchburi Road, Bangkapi, Huaykwang, Bangkok, 10320	02723 4488	2 years
TÜRKIYE	GROUPE SEB ISTANBUL AS Beybi Giz Plaza Dereboyu Cad. Meydan Sok. No: 28 K.12 Maslak	216 444 40 50	2 YIL
U.S.A.	GROUPE SEB USA 2121 Eden Road Millville, NJ 08332	800-769-3682	1 year
Україна/ UKRAINE	ТОВ «Груп СЕБ Україна» Вул. Драгоманова 31 Б, офіс 1 02068 Київ, Україна	044 492 06 59	2 роки/ years
UNITED KINGDOM	GROUPE SEB UK Ltd. 11-49 Station Road Langley, Slough Berkshire SL3 8 DR	0845 602 1454	1 year
VENEZUELA	GROUPE SEB VENEZUELA Av Eugenio Mendoza, Centro Letonia, Torre ING Bank, Piso 15, Ofc 155 Urb. La Castellana, Caracas	0800-7268724	2 anno
VIETNAM	GROUPE SEB VIETNAM (Representative office) 127-129 Nguyen Hue Street District 1, Ho Chi Minh City, Vietnam	+84-8 3821 6395	1 year

TEFAL / T-FAL INTERNATIONAL GUARANTEE

Date of purchase: / Date d'achat / Fecha de compra /
Data da compra / Data d'acquisto / Kaufdatum / Aankoopdatum / Købsdato / Inkøpsdatum /
Kjøpsdato / Ostopäivä / Data zakupu / Data vânzării / Isigijimo data/ Ostukuupäev / Datum nakupa /
Sorozatszám / Dátum nákupu / Pirkuma datums / Datum Kupovine / Datum kupnje / Data
cumpărării / Datum nákupu / Tarikh pembelian / Tanggal pembelian / Ngay mua hàng/ Satin alma
tarihli / Дата продажи / Дата продаж / Дата на закупуване / Датум на купување / Сатылган
мерзімі / Ημερομηνία αγοράς/ Ψαδωνηη ορη /วันที่ซื้อ / 購買日期 / 購入日 / 구입일자 / تاریخ
خرید/ تاریخ الشراء

Product reference: / Référence du produit / Referencia del
producto / Nome do produto / tipo de prodotto / Typnummer des Gerätes / Artikelnummer van het
apparaat / Referencenummer / Produktreferens / Artikelnummer / Tuotenumero / referenja
produktu / Model / Gaminio numeris / Toote viitenumber / Tip aparata / Vásárlás kelte / Тип
výrobku / Produkta atsauces numurs / Model proizvoda / Oznaka proizvoda / Cod produs / Produkt
rujukan / Referensi produk / Mã sản phẩm/ Ürün kodu / Модель / Модель / Модел на уреда /
Модели / Кодικός προϊόντος / Уηηηη / รุ่นผลิตภัณฑ์ / 產品模型 / 製品レファレンス番号 / 제품명 /
مرجع كامل محصول / مرجع المنتج الكامل

Retailer name & address:
/ Nom et adresse du vendeur / Nombre y direcció del minorista / Nome e endereço do revendedor
/ Nome e indirizzo delnegozzio / Name und Anschrift des Händlers / Naam en adres van de dealer /
Forhandler navn & adresse / Återförsäljarens namn och adress / Forhandler navn og adresse /
Jälleenmyyjän nimi ja osoite / nazwa i adres sprzedawcy / Numele și adresa vânzătorului /
Parduotuvės pavadinimas ir adresas / Müüja kauplus ja aadress / Naziv in naslov trgovine /
Típusszám / Názov a adresa predajcu / Veikala nosaukums un adrese / Naziv i adresa maloprodaje /
Naziv i adresa prodavca / Naziv i adresa prodajnog mjesta / Nume și adresă vânzător / Název a
adresa prodejece / Nama dan alamat peruncit / Nama Toko Penjual dan alamat / Tên và địa chỉ cửa
hàng bán/ Satıcı firmanın adı ve adresi / Название и адрес продавца / Назва і адреса продавця /
Търговки обект / Назив и адреса на продавницата / Сатушының аты және мекен-жайы /
Επωνυμία και διεύθυνση καταστήματος / Ψαδωνηηη ηηηηηηηη η ηηηηηηηη η ηηηηηηηη /
ชื่อและที่อยู่ของห้าง/ร้านที่ซื้อ / 零售商的店名和地址 / 販売店の名前、住所 / 소매점 이름과 주소 /
نام و آدرس خرده فروش / اسم بائع التجزئة و عنوانه

Distributor stamp / Cachet distributeur / Sello del distribuidor /
Carimbo do revendedor / Timbro del negozio / Händlerstempel / Stempel van de dealer /
Forhandler stempel / Återförsäljarens stämpel / Forhandler stempel / Jälleenmyyjän leima / pieczęć
sprzedawcy / Ștampila vânzătorului / Antspaudas / Tempel / Žig trgovine / Eladó neve, címe/
Razítko predajcu / Zīmogs / Pečat maloprodaje/ Pečat prodavca / Pečat prodajnog mjesta / Ștampila
vânzătorului/ Razítko prodejece/ Cap peruncit / Cap dari Toko Penjual / Cửa hàng bán đóng dấu/
Satıcı Firmanın Kaşesi / Печать продавца / Печатка продавця / Печат на търговския обект /
Печат на продавницата / Сатушының мөрі / Σφραγίδα καταστήματος / Ψαδωνηηηη ηηηηηηηη
ตราประทับของห้าง/ร้านที่ซื้อ / 零售商的蓋印 / 販売店印 / 소매점 직인 / ختم بائع التجزئة / مهر خرده
فروش

