



# User Guide

True Wireless Earbuds

# TW-E5B

# Contents

<b>Introduction</b>	<b>4</b>
<hr/>	
About this User Guide .....	4
Cautions regarding product handling .....	5
Advantages of this product .....	6
Accessory and part names .....	8
<b>Charging and Powering</b>	<b>10</b>
<hr/>	
Charging the earbuds .....	10
Charging the charging case .....	12
Turning on the power .....	14
Turning off the power .....	15
Remaining Battery Power .....	16
<b>Bluetooth® Connectivity</b>	<b>17</b>
<hr/>	
Pairing for the First Time .....	17
Pairing with a Different Device .....	19
Connecting to a Device Already Paired .....	21
<b>Wearing This Product</b>	<b>22</b>
<hr/>	
Putting on the earbuds .....	22
Replacing the eartips .....	23
<b>Operation (Audio Playback and Phone Calls)</b>	<b>24</b>
<hr/>	
Playing back audio on this product .....	24
Making ambient sounds easier to hear (AMBIENT SOUND) .....	25
Talking on the phone .....	26
Starting the voice assistant .....	27

**Dedicated Application 28**

---

**About the “Headphone Control” app ..... 28**  
**App settings ..... 29**

**Troubleshooting 32**

---

**Read this first ..... 32**  
**Cannot connect ..... 33**  
**Power will not turn on ..... 34**  
**The product cannot be charged ..... 35**  
**The product does not operate or play back ..... 36**  
**No sound can be heard ..... 37**  
**Sound can only be heard from one earbud ..... 38**  
**Sound is not good or sounds strange ..... 39**  
**The sound is distorted, noisy or choppy ..... 40**  
**Using only one of the earbuds ..... 41**  
**Initializing (performing a factory reset) ..... 42**  
**Updating the firmware ..... 44**  
**List of support centers ..... 45**

**Appendix 46**

---

**List of operations ..... 46**  
**List of indicator displays and audio messages ..... 48**  
**Specifications ..... 50**  
**Trademarks ..... 52**

# Introduction

## About this User Guide

The User Guide is intended for users of this product, and explains how to connect and operate the product.

- The precautions and other matters in this Guide are classified as follows.



### **WARNING**

This content indicates “risk of serious injury or death.”



### **CAUTION**

This content indicates “risk of injury.”

### **NOTICE**

Indicates points that you must observe in order to prevent product failure, damage or malfunction and data loss, as well as to protect the environment.

### **NOTE**

Indicates notes on instructions, restrictions on functions, and additional information that may be helpful.

- All illustrations and screens shown in this Guide are for explanatory purposes.
- All company names, product names and other such listings in this Guide are the registered trademarks or trademarks of their respective companies.
- Text labeled as [search tag] is for the purpose of searching. These tags are used as links from the “Quick Start Guide” to the “User Guide.”

## Cautions regarding product handling

Please read the “Safety Brochure” included with this product and use caution regarding the following points.

### Waterproof performance

The waterproof performance of this product are as shown below. Product failures caused by water ingress due to incorrect handling are not covered by the warranty.

- **Earbuds**

- The waterproof performance of the body of these earbuds is compliant with IPX5 standards. The earbuds are protected by direct jets of water from all directions. (Earbud nozzle: excluding the sound conduit)
- The waterproof performance of this product will not continue to last, and may degrade through regular use.

- **Charging case**

The charging case and the included USB power cable are not waterproof. Use caution regarding the following to avoid electric shock or product failure.

- Do not expose this product to liquids such as sweat, rainwater or seawater.
- Thoroughly wipe off any sweat, rainwater, seawater or other liquids that get on the earbuds before placing them back in the charging case.

#### About IPX

- IPX refers to a product's “liquid ingress protection” as cited in JIS C 0920 (the harmonized standard of IEC 60529), “Degrees of protection provided by enclosures (IP Code)”.
- These are provisions that guarantee the performance of a product in fresh water or tap water at room temperature. This does not guarantee equivalent performance in warm water, seawater or the like.

### About the charging performance

This product uses lithium-ion batteries in both the earbuds and in the charging case. Lithium-ion batteries are consumable items. To extend the life of the batteries as long as possible, use caution regarding the following.

- If the product is not used for a long period of time, it may take longer to recharge the batteries.
- When storing the product for a long time, charge the product around once every six months to avoid excessive discharge.
- If the duration of the battery's charge is too short, it may have reached the end of its lifespan. Contact Yamaha dealer or service center.

## Advantages of this product

This product is a set of wireless earbuds that connect to Bluetooth devices such as a portable music player or smartphone.

### **High-definition playback of sound from Bluetooth devices**

This product supports Qualcomm® aptX™ Adaptive as well as the SBC and AAC codecs.

Qualcomm® aptX™ Adaptive Audio is an audio codec that offers both high quality and high connectivity performance in response to audio signal interruptions.

### **Supports Qualcomm TrueWireless™ Mirroring**

This product features technology that lets you connect both left and right earbuds at the same time to a smartphone, music player or other device for high-definition sound. The earbuds switch between primary and secondary devices automatically for a stable connection.

### **AMBIENT SOUND**

This function makes it easier to hear the sounds around you, such as announcements made on public transportation, the sounds of passing cars and so on.

- “Making ambient sounds easier to hear (AMBIENT SOUND)” (p.25)

### **LISTENING CARE**

This product features LISTENING CARE, which lets you enjoy rich sound quality even at a low volume. Focusing on the characteristics of the human ear where the low- and high-end sounds become harder to hear at lower volumes, as well as how things sound differently in different listening environments, this feature corrects the sound balance for the optimal sound to match the volume. By rendering a natural sound that's easy to listen to, this feature reduces the load on your ears caused by excessive levels.

### **GAMING MODE**

Enabling this function helps improve latency when you are watching a video or playing a game that is affected by lag or delay.

### **Smartphone support**

You can use this product to talk on the phone and start up the voice assistant while connected to this product.

### **Dedicated smartphone app: Headphone Control**

Install the Headphone Control app on your smartphone to configure more detailed settings.

You can switch ON/OFF for AMBIENT SOUND, LISTENING CARE, GAMING MODE and so on.

**NOTE**

- While the AMBIENT SOUND feature makes it easier to hear sounds around you, it does not guarantee that you will be able to hear everything. You may be unable to hear ambient sounds if you've turned up the volume of the audio, or in certain situations.
- When using GAMING MODE, the video/audio latency may change or the sound quality and connection stability may degrade, depending on the usage environment and how you wear the product.

**Related links**

- “Pairing for the First Time” (p.17)
- “Making ambient sounds easier to hear (AMBIENT SOUND)” (p.25)
- “Starting the voice assistant” (p.27)
- “About the “Headphone Control” app” (p.28)
- “App settings” (p.29)

## Accessory and part names

Make sure that all of the accessories are included with this product.

### Earbuds

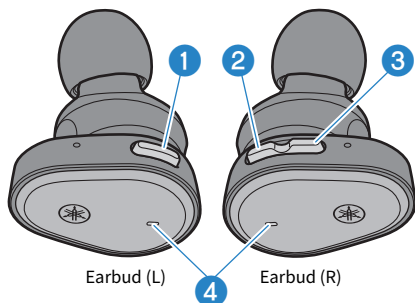

- 1 **Function key**
- 2 **+ (plus) key**
- 3 **- (minus) key**
- 4 **Indicator**

### Charging case

Front

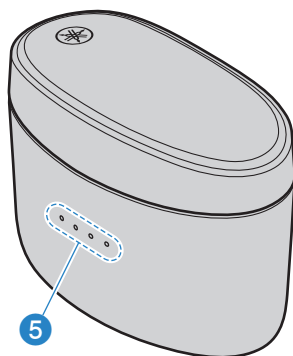

Back

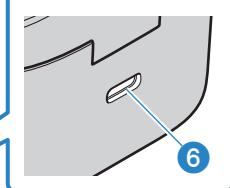

- 5 **Charging indicators**
- 6 **Charging connector**

**USB power cable (30 cm (11-3/4 in); type A to C)**

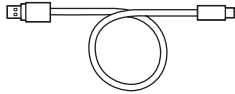

**Eartips (XS, S, M, L; one set each)**

Note: The M-size eartips are pre-attached.

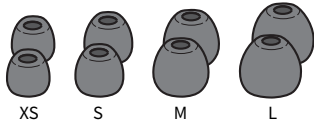

**Quick Start Guide**

**Safety Brochure**

**NOTE**

- The earbuds are stored in the charging case.
- The earbuds feature a built-in microphone.
- The charging case contains a battery for charging the earbuds.

# Charging and Powering

## Charging the earbuds

Charge the earbuds before use by placing them in the charging case.



### CAUTION

- The charging case is not waterproof. Thoroughly wipe off any sweat, rainwater, seawater or other liquids that get on the earbuds before placing them back in the charging case.
- Charge this product within a temperature range of 5 to 40°C.

### When using this product for the first time

- Remove the earbuds from the charging case the first time you use this product, and peel off the isolation sheets found on each.

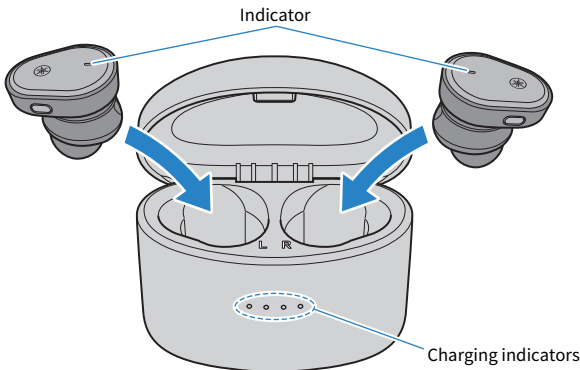
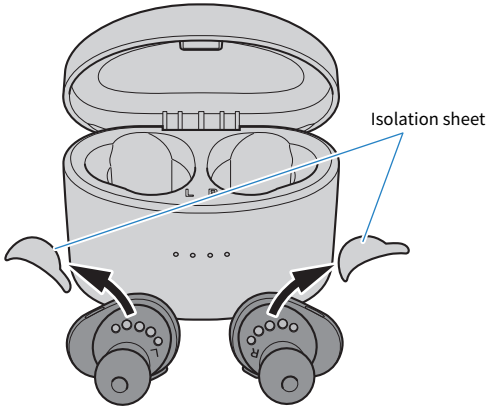

**1 Open the charging case lid.**

**2 Place the earbuds in the charging case.**

The earbud indicators light up red while charging, and turn off when charging is completed.

Charging takes about 1.5 hours.

**NOTE**

- Once you place the earbuds in the charging case, the indicators on the charging case will show the remaining battery power for five seconds (except when the charging case itself is still charging).
- You cannot connect the earbuds via Bluetooth or use them for playback while they are recharging.

**Related links**

“Appendix” (p.46)

## Charging the charging case

To charge the charging case, connect the included USB power adaptor.



### CAUTION

- The charging case is not waterproof. Do not expose this product to liquids such as sweat, rainwater or seawater.
- Be sure to use the USB power cable that was included with this product.
- When using a USB power adaptor, be sure that the commercially-available adaptor is compatible with 5 V DC (at least 0.5 A) power output.
- When charging this product inside of China, be sure to use a USB power adaptor that is approved by CCC.
- Charge this product within a temperature range of 5 to 40°C.

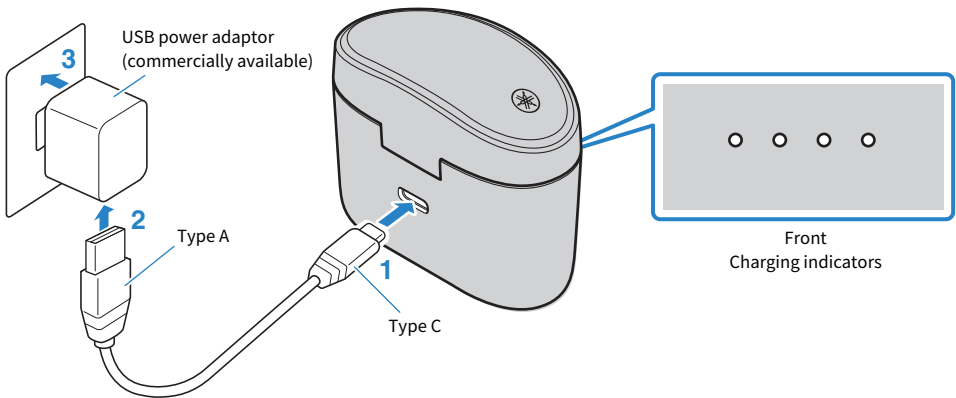

**1 Plug the USB power cable (type C side) into the charging case.**

**2 Plug the USB power cable (type A side) into the USB power adaptor.**

**3 Plug the USB power adaptor into the power outlet.**

Charging will begin. Charging takes about 2.5 hours.

While the case is charging, the indicators light up as shown below.

Remaining battery power	Indicator
100%	
75–100%	
50–75%	
25–50%	
0–25%	

## Charging and Powering > Charging the charging case

: Lights up

: Flashes

: Not lit

### **NOTE**

- You can also charge the earbuds while the charging case is charging.
- You can charge from the USB port on your computer instead of using a USB power adaptor.
- Once you place the earbuds in the charging case, the indicators on the charging case will show the remaining battery power for five seconds (except when the charging case itself is still charging).

## Turning on the power

Once you remove the earbuds from the charging case, the earbuds will turn on.

### 1 Remove the earbuds from the charging case.

The indicators light up as shown below, and the power turns on.

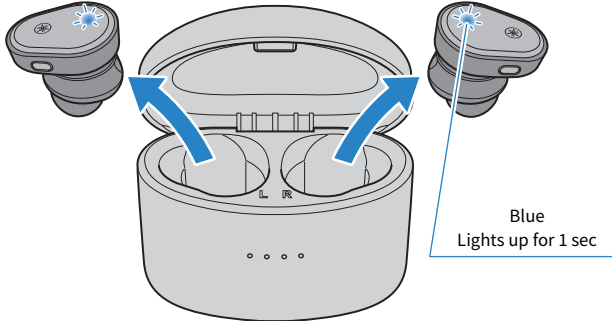

### NOTE

- When an earbud is low on battery power, its indicator will flash red three times when the power is turned on. If this happens, charge the earbud.
- If the earbuds have been removed from the charging case or if they do not turn on when removed from the charging case, hold down the function key on earbud (L) and the + (plus) key on earbud (R) until the indicators light up blue to turn the earbuds on.

### Related links

“Remaining Battery Power” (p.16)

## Turning off the power

When you put the earbuds back into the charging case, the earbuds turn off.

### 1 Place the earbuds in the charging case.

The earbud power will turn off, and the product will enter charging mode.

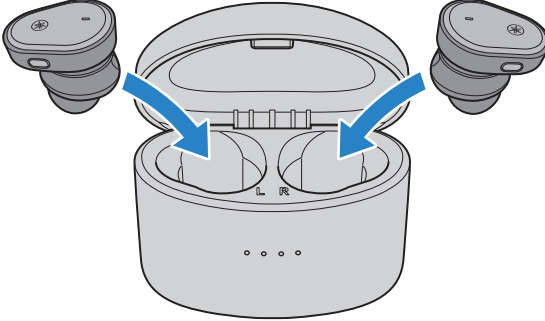

#### NOTE

When you want to turn off the earbuds without putting them back in the charging case, hold down the function key on earbud (L) and the + (plus) key on earbud (R) until the indicators light up red. You will hear the “Power Off” audio message in the earbuds.

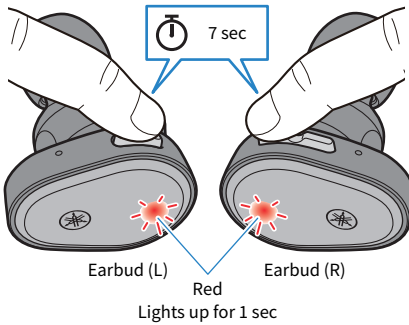

## Remaining Battery Power

After this product is turned on, you can check how much battery power is left from the audio messages in the earbuds and by the indicators.

- **Audio messages:**

- Battery High: plenty of charge remaining
- Battery Medium: moderate charge remaining
- Battery Low: small amount of charge remaining

### **NOTE**

You can check the remaining battery power of the charging case in the following situations.

- While charging the charging case
- Right after placing the earbuds into the charging case (except when the charging case itself is charging)

### **Related links**

“Charging the charging case” (p.12)

# Bluetooth® Connectivity

## Pairing for the First Time

When first connecting this product to a Bluetooth device (such as a smartphone), follow the steps below to pair (register) this product with that device.

[Search tag] #Q02 Pairing

### 1 Remove the earbuds from the charging case.

The earbuds will turn on and both earbuds automatically connect. Either earbud (L) or (R) will be the primary earbud, and its indicator lights up as shown in the illustration below as the unit enters pairing standby mode. You will hear the “Pairing” audio message in the earbud. Either earbud (L) or earbud (R) can become the primary earbud.

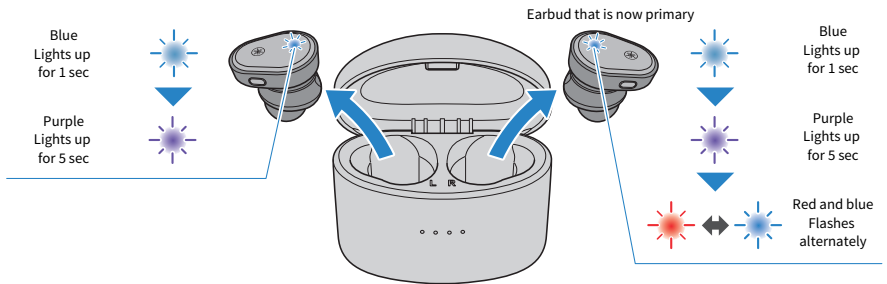

#### NOTE

The indicators may flash blue for a while after you remove the earbuds from the charging case.

### 2 Activate Bluetooth on your Bluetooth device.

A list of Bluetooth devices that can be connected will be shown.

### 3 Select this product from the list on your Bluetooth device.

Select the listing that reads “Yamaha...” and not the listing that reads “LE-Yamaha...”.  
If a passkey is required when connecting, input “0000”.

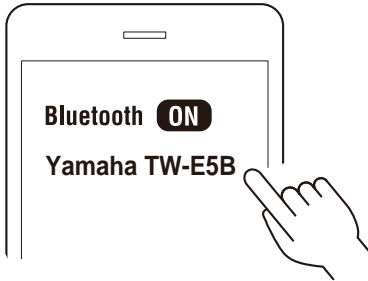

Once connected, the indicator on the primary earbud lights up as shown below. You will hear the “Pairing Successful” and “Connected” audio messages in the earbud.

Earbud that is now primary

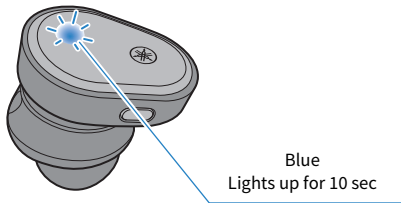

#### NOTE

- Pairing standby mode will automatically end on this product after about two minutes. To pair again or if the connection was unsuccessful, place the earbuds back into the charging case and start again at step 1.
- If the earbuds (L) and (R) do not automatically connect, put them back into the charging case and take them out again.

#### Related links

- “Pairing with a Different Device” (p.19)
- “Connecting to a Device Already Paired” (p.21)
- “About the “Headphone Control” app” (p.28)
- “Using only one of the earbuds” (p.41)

## Pairing with a Different Device

Follow the steps below to pair with another Bluetooth device, or to try pairing with the same device again.

Note that this product cannot connect to more than one Bluetooth device at the same time. If this product is already connected to another Bluetooth device, disconnect it and then follow these steps.

[Search tag] #Q02 Pairing

- 1 With earbuds (L) and (R) turned on, hold down the function key on earbud (L) and the + (plus) key on earbud (R) for about three seconds.**

Either earbud (L) or (R) will be the primary earbud, and its indicator alternately flashes red and blue while you hear the message “Pairing.” This means that the earbud is in pairing standby mode.

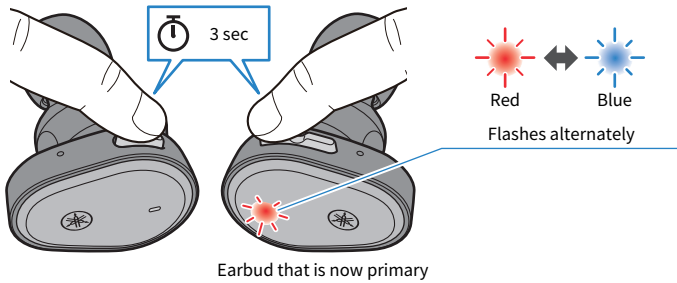

- 2 Activate Bluetooth on the Bluetooth device.**

A list of Bluetooth devices that can be connected will be shown.

### 3 Select this product from the list on your Bluetooth device.

Select the listing that reads “Yamaha...” and not the listing that reads “LE-Yamaha...”.  
If a passkey is required when connecting, input “0000”.

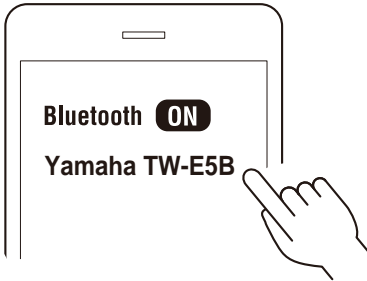

If successfully connected, you will hear the “Pairing Successful” and “Connected” audio messages in the earbud that is flashing red and blue. The indicator displays as shown below.

Earbud that is now primary

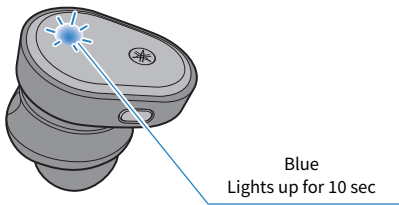

Earbud (L) and (R) connect automatically and are ready for use.

#### NOTE

- Pairing standby mode will automatically end on this product after about two minutes. To pair again, start from step 1.
- If the earbuds (L) and (R) do not automatically connect, put them back into the charging case and take them out again.
- Up to three Bluetooth devices can be registered with this product. If you pair a device beyond the maximum number, the information for device you first paired (the oldest pairing) will be deleted.
- This product does not support multi-point connectivity (connection to multiple devices at the same time).

#### Related links

- “Pairing for the First Time” (p.17)
- “Connecting to a Device Already Paired” (p.21)
- “About the “Headphone Control” app” (p.28)
- “Using only one of the earbuds” (p.41)

## Connecting to a Device Already Paired

Here's how to connect to a Bluetooth device to which this product has already been paired.

### 1 Activate Bluetooth on the Bluetooth device.

### 2 Remove the earbuds from the charging case.

The earbuds will turn on and both earbuds automatically connect to the last Bluetooth device to which they were connected. Once connected, the indicators light up as shown below.

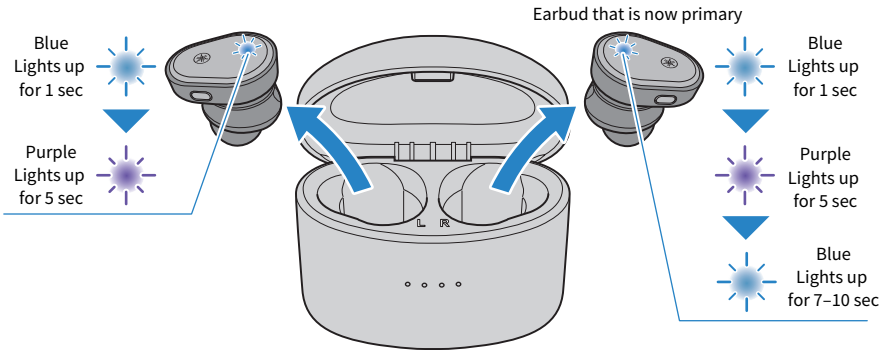

If successfully connected, you will hear the “Connected” audio message in the earbud.

If the earbuds do not automatically connect to a Bluetooth device, they are waiting for a connection or are in pairing standby mode. Make the connection to the earbuds from your Bluetooth device.

#### NOTE

- One of the earbuds (L or R) will be the primary earbud when connecting, according to their remaining battery power.
- If the earbuds (L) and (R) do not automatically connect, put them back into the charging case and take them out again.
- This product does not support multi-point connectivity (connection to multiple devices at the same time).

#### Related links

- “Pairing for the First Time” (p.17)
- “Pairing with a Different Device” (p.19)
- “Using only one of the earbuds” (p.41)

# Wearing This Product

## Putting on the earbuds

Check the markings on the L (left) and R (right) earbuds to make sure they are worn in the correct ear. Rotate the earbuds slowly to adjust them so that they fit well in your ears after you put them on.

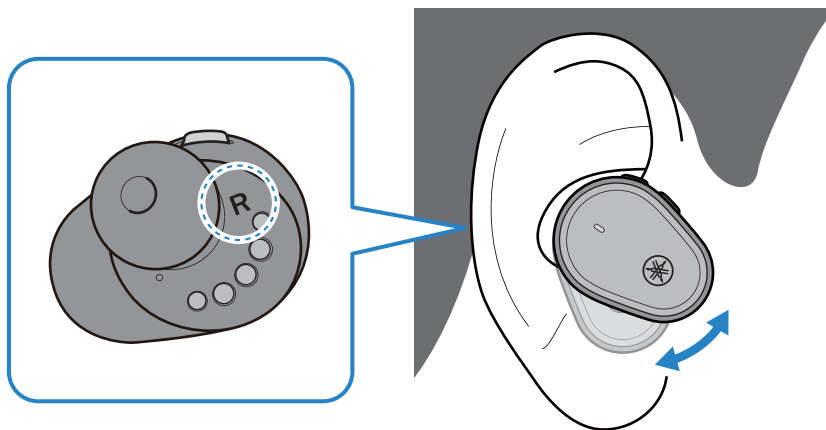

### CAUTION

- Do not forcibly press on or move the earbuds once you've put them on. Doing this may damage your ears.
- If the earbuds still aren't fitting snugly in your ears, try replacing the eartips.
- As this product is designed to fit in your ears, your ears may feel tired depending on how the earbuds fit. If you notice any skin problems after coming into direct contact with this product, stop using this product immediately. If the problem does not improve, consult with a physician.

### Related links

["Replacing the eartips" \(p.23\)](#)

## Replacing the eartips

When using different eartips, select the size that matches your ears. When putting the earbuds on, use the eartips that keep out ambient sounds as much as possible while the audio is stopped.

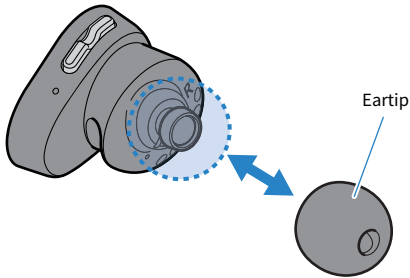

### NOTE

Four sizes of eartips are included with this product. The earbuds come pre-attached with M-size eartips.



### CAUTION

- Do not use broken eartips or wear the earbuds without eartips. Doing so may damage your ears.
- Firmly attach the eartips. Failure to do so may cause them to come loose inside your ears, which may damage your ears. If an eartip comes loose inside your ear, consult a physician.
- Once removed, keep the eartips out of reach of children, to avoid them being accidentally swallowed.

# Operation (Audio Playback and Phone Calls)

## Playing back audio on this product

You can operate this product using the respective keys during playback as follows.

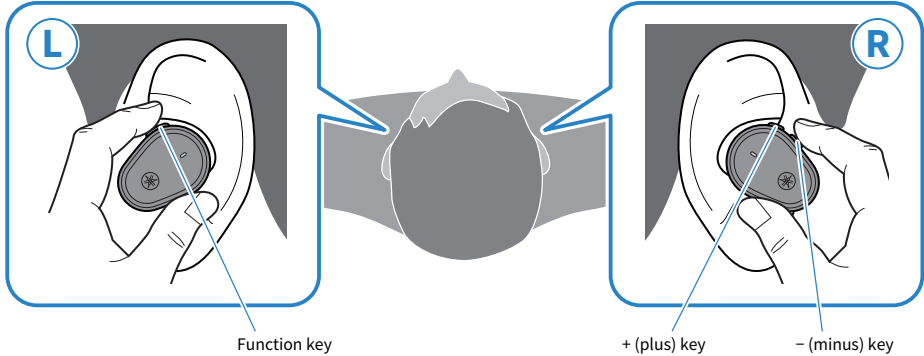

### Volume controls

- Turn the volume up  
Press the + (plus) key.
- Turn the volume down  
Press the - (minus) key.

### Playing back audio

- Pause/play  
Press the function key.
- Skip to the next track  
Press the + (plus) key twice.
- Go back to the beginning of the track (while in the middle of the track), or back to the previous track (when at the beginning of a track)  
Press the - (minus) key twice.  
The operation may differ, depending on the Bluetooth device or app you use.

### NOTE

When connecting to a device (such as a smartphone) on which the volume can be adjusted, you can also adjust the volume using that device.

- To select a song for playback, operate the connected device.

### Related links

- “App settings” (p.29)
- “Using only one of the earbuds” (p.41)

## Making ambient sounds easier to hear (AMBIENT SOUND)

Enabling AMBIENT SOUND makes it easier to hear the sounds around you, such as announcements made on public transportation, the sounds of passing cars and so on.

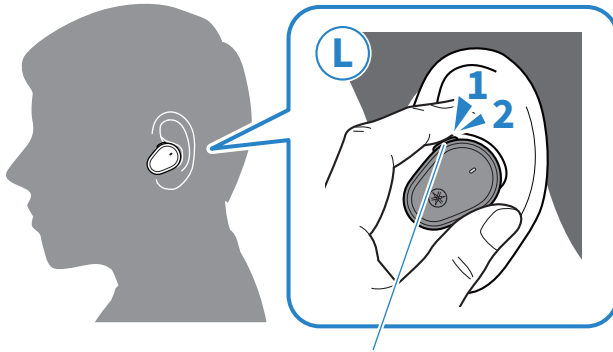

Function key

### Switching the AMBIENT SOUND/OFF on and off

#### 1 Press the function key twice.

Press the key twice to toggle between enable and disable.

AMBIENT SOUND → OFF → back to AMBIENT SOUND

- When AMBIENT SOUND is ON: an ascending piano chord is heard.
- When AMBIENT SOUND is OFF: a low piano chord is heard.

#### NOTE

- The default setting is OFF.
- While the AMBIENT SOUND feature makes it easier to hear sounds around you, it does not guarantee that you will be able to hear everything. You may be unable to hear ambient sounds if you've turned up the volume of the audio, or in certain situations.
- You can also set this with the Headphone Control app. The settings are as follows.
  - ON: enables AMBIENT SOUND.
  - OFF (default setting): this is normal playback mode.
- Depending on the type of sound you are playing back and what is going on around you, the ambient sound may not be so easy to hear. In this case, pause the playback.
- Do not cover the earbuds with your hand. If your hand is covering the mic, the AMBIENT SOUND effect will not work properly, and you may hear noise.
- The AMBIENT SOUND effect does not operate during a phone call or when a call is coming in.

#### Related links

- "Playing back audio on this product" (p.24)
- "App settings" (p.29)

## Talking on the phone

You can use this product to talk on the phone when connecting to a Bluetooth device such as a smartphone. Operate this product as follows.

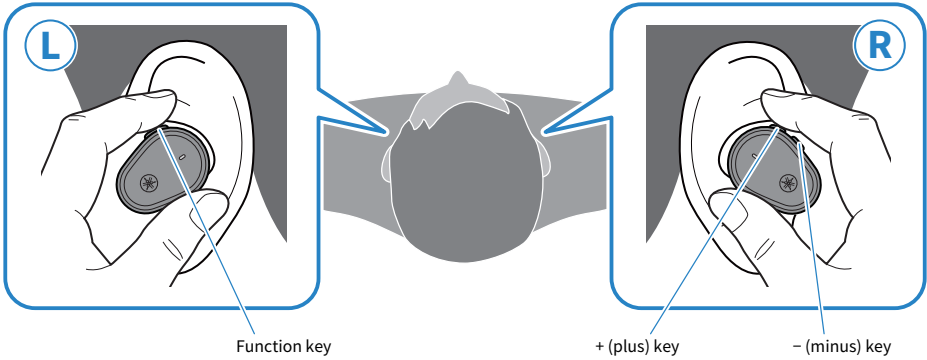

- Receive a phone call  
When a phone call comes in, press the function key.
- End a phone call  
During the phone call, press the function key for about one second.
- Ignore a call  
When a phone call comes in, press the function key for about one second.
- Turn the volume up  
During the phone call, press the + (plus) key.
- Turn the volume down  
During the phone call, press the - (minus) key.

### NOTE

When a call is coming in, any audio being played will be paused. Audio playback will automatically resume when the call ends or you ignore the call.

## Starting the voice assistant

You can use this product to control a voice assistance feature such as Siri or Google Assistant. This feature is available when you connect this product to a Bluetooth device that supports voice assistance.

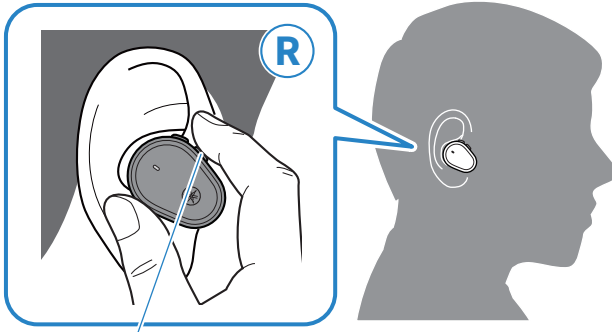

– (minus) key

- Start voice assistant  
Hold down the – (minus) key (about one second).
- Stop voice assistant
  - When using Siri  
Hold down the – (minus) key (about one second).
  - When using Google Assistant  
Operate using your Bluetooth device.

### NOTE

The operations for the voice assistant feature will vary depending on your Bluetooth device. See the user's manual of your Bluetooth device for details.

# Dedicated Application

## About the “Headphone Control” app

The Headphone Control smartphone app is a dedicated app for getting the best sound quality from your Yamaha earbuds or headphones.

[Search tag] #Q03 App



This app will let you do the following.

- Show the status of your earbuds/headphones (such as remaining battery power)
- Make detailed settings on your earbuds/headphones

Install the app from the App Store (iOS devices) or on Google Play (Android™ devices). See the information about the app on each store for details.

## App settings

This explains the settings and items you can check using the Headphone Control app.

[Search tag] #Q03 App

### NOTE

The app screen and items may differ, depending on your product.

### Main screen



- AMBIENT SOUND

This function makes it easier to hear the sounds around you, such as announcements made on public transportation, the sounds of passing cars and so on.

#### Settings

- ON: enables AMBIENT SOUND
- OFF(default setting): AMBIENT SOUND disabled (normal playback mode)

- LISTENING CARE

When LISTENING CARE is enabled, this product automatically adjusts the sound quality according to the playback volume. This feature adjusts the frequency balance, offering rich sound quality playback even at a low volume.

**Settings**

- ON (default setting): enables LISTENING CARE
- OFF: disables LISTENING CARE

- GAMING MODE

This makes the audio and video sound more in sync when you are watching a video or playing a game.

**Settings**

- ON: enabled GAMING MODE
- OFF (default setting): disabled GAMING MODE

- EQUALIZER

This is a five-band graphic equalizer that lets you create your own custom sound settings.

**EQUALIZER default settings**

- RESET: the gain of all equalizers is reset to 0 dB.

**Gain settings for each equalizer**

- 0 dB (default setting)

- Auto power-off timer

Sets the time it takes for the power to turn off after Bluetooth has been disconnected.

**Settings**

- OFF
- 5 minutes (default setting)
- 30 minutes
- 1 hour
- 3 hours

**NOTE**

- The AMBIENT SOUND does not guarantee that you will be able to hear everything. You may be unable to hear ambient sounds if you've turned up the volume of the audio, or in certain situations.
- When using GAMING MODE, the video/audio latency may change or the sound quality and connection stability may degrade, depending on the usage environment and how you wear the product.

## Menu screen

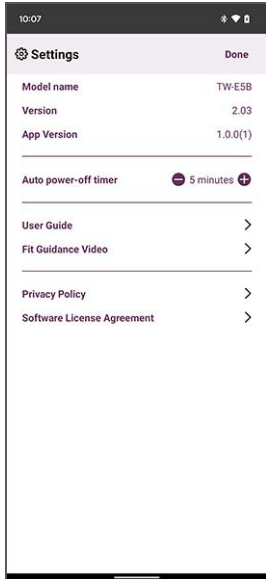

- Check for firmware update  
Checks whether new firmware has been released, and performs updates.
- User Guide  
Accesses the User Guide
- Google Analytics  
Displays information regarding Google Analytics.

# Troubleshooting

## Read this first

If this product does not operate normally while you are using it, first check the following.

[Search tag] #Q01 Troubleshooting

● **After putting the earbuds back into the charging case, wait for at least 10 seconds and then take them out again.**

If this does not solve the problem, initialize (factory reset) the earbuds.

- “Initializing (performing a factory reset)” (p.42)

● **Make sure that this product has been sufficiently charged.**

- “Charging the earbuds” (p.10)
- “Charging the charging case” (p.12)

● **Update the firmware of this product to the latest version.**

- “Updating the firmware” (p.44)

● **Check the following items according to the trouble you are experiencing.**

- “Cannot connect” (p.33)
- “Power will not turn on” (p.34)
- “The product cannot be charged” (p.35)
- “The product does not operate or play back” (p.36)
- “No sound can be heard” (p.37)
- “Sound can only be heard from one earbud” (p.38)
- “Sound is not good or sounds strange” (p.39)
- “The sound is distorted, noisy or choppy” (p.40)
- “Using only one of the earbuds” (p.41)
- “Initializing (performing a factory reset)” (p.42)

## Cannot connect

● **Earbuds (L) and (R) are not connecting properly.**

Put the earbuds back into the charging case and then take them out again.

The earbuds will turn on and both earbuds automatically connect. The indicators display as shown below.

- Power on: Blue Lights up for 1 sec
- Earbuds (L) and (R) are now connected: Purple Lights up for 5 sec

The indicators may flash blue for a while after you remove the earbuds from the charging case.

● **The product is not pairing correctly.**

If the information for this product still remains in the list of connected devices on your Bluetooth device, delete that information and try pairing again.

- “Pairing with a Different Device” (p.19)

● **The information for a Bluetooth device that was registered on this product was deleted.**

If you pair a device beyond the maximum number of pairable Bluetooth devices, the information for device you first paired (the oldest pairing) is deleted. Pair this product once more.

- “Pairing with a Different Device” (p.19)

● **This product may already be connected to another Bluetooth device.**

On your Bluetooth device, remove the connection with this product and then connect this product again.

● **This product and your Bluetooth device may be too far apart.**

Move this product closer to the Bluetooth device.

● **A device that emits electromagnetic waves (such as a microwave oven, access point and so on) might be nearby.**

Do not use this product near other devices that emit electromagnetic waves.

## Power will not turn on

● **There may not be enough battery power left.**

Charge this product.

- “Charging the earbuds” (p.10)

● **The battery power of the charging case may have been depleted while charging the earbuds.**

Turn on the power manually by holding down the function key and the + (plus) key for about one second until the indicator lights up blue. You can also do this by charging the charging case.

- “Charging the charging case” (p.12)
- “Turning on the power” (p.14)

● **The product is temporarily not functioning in a stable way.**

After putting the earbuds back into the charging case, wait for at least 10 seconds and then take them out again.

If this does not solve the problem, initialize (factory reset) the earbuds.

- “Initializing (performing a factory reset)” (p.42)

## The product cannot be charged

- **Your computer is not turned on (when charging from your computer).**  
Turn the power of your computer on, and then charge this product.
- **You may have been using a USB power cable other than the one included with this product.**  
Use the included USB power cable to make sure the product correctly charges.

## The product does not operate or play back

● **The earbuds are still charging.**

You cannot use this product while they are charging. Use the earbuds after charging is finished.

● **There is not enough battery power.**

Charge the earbuds.

- “Charging the earbuds” (p.10)
- “Charging the charging case” (p.12)

● **The product is temporarily not functioning in a stable way.**

After putting the earbuds back into the charging case, wait for at least 10 seconds and then take them out again.

If this does not solve the problem, initialize (factory reset) the earbuds.

- “Initializing (performing a factory reset)” (p.42)

## No sound can be heard

● **The earbuds are not connected to a Bluetooth device.**

Pair this product.

- “Pairing for the First Time” (p.17)
- “Pairing with a Different Device” (p.19)

● **The volume is too low.**

Raise the volume.

- “Playing back audio on this product” (p.24)

● **The audio stopped playing back.**

Start playback.

- “Playing back audio on this product” (p.24)

## Sound can only be heard from one earbud

### ● **Earbuds (L) and (R) are not connecting properly.**

Put the earbuds back into the charging case and then take them out again.

The earbuds will turn on and both earbuds automatically connect. The indicators display as shown below.

- Power on: Blue Lights up for 1 sec
- Earbuds (L) and (R) are now connected: Purple Lights up for 5 sec

The indicators may flash blue for a while after you remove the earbuds from the charging case.

### ● **The signal may not be coming in clearly, making the connection unstable.**

Move away from wireless devices such as access points, or appliances that produce electromagnetic waves such as microwave ovens. After placing both earbuds into the charging case, take them out again.

### ● **You may be using a smartphone app that generates sound from only one channel.**

Check whether you can hear sound coming from both left and right channels by playing back sound from a different app.

### ● **One of the earbuds might be turned off.**

Turn the power on.

- “Turning on the power” (p.14)

### ● **The connection information for the registered Bluetooth device may not be working properly.**

Delete the connection information of this product from the Bluetooth device, and then pair the earbuds with the Bluetooth device.

- “Pairing with a Different Device” (p.19)

## Sound is not good or sounds strange

● **You might be wearing the earbuds on the wrong sides (L/R).**

Check that the left (L) and right (R) earbuds are worn on the correct sides.

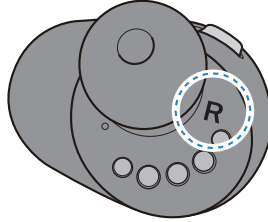
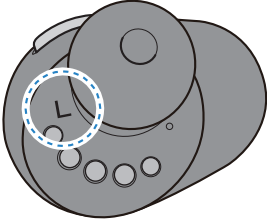

- “Putting on the earbuds” (p.22)

● **The eartips don't fit my ears.**

Replace the eartips with the size that match your ear shape.

- “Replacing the eartips” (p.23)

## The sound is distorted, noisy or choppy

● **The signal may not be coming in clearly, making the connection unstable.**

Move away from wireless devices such as access points, or appliances that produce electromagnetic waves such as microwave ovens.

Try placing the connected Bluetooth device as close to this product as you can.

Devices with wireless network connectivity may transmit signals that obstruct Bluetooth communications. In this case, turn off the wireless network connectivity feature on your Bluetooth device.

● **The product is temporarily not functioning in a stable way.**

After putting the earbuds back into the charging case, wait for at least 10 seconds and then take them out again.

If this does not solve the problem, initialize (factory reset) the earbuds.

- “Initializing (performing a factory reset)” (p.42)

● **GAMING MODE is ON.**

Set GAMING MODE to OFF.

When using GAMING MODE, the video/audio latency may change or the sound quality and connection stability may degrade, depending on the usage environment and how you wear the product.

- “Playing back audio on this product” (p.24)
- “App settings” (p.29)

## Using only one of the earbuds

Pair the earbud you want to use with the Bluetooth device.

When doing this, note the following.

- This product does not offer a function to convert stereo sound to monaural sound.
- The L and R side keys on the earbuds work differently. When using only one earbud, use your Bluetooth device to operate controls like playback or talking on the phone.

## Initializing (performing a factory reset)

Follow the steps below to initialize (perform a factory reset on) this product.

[Search tag] #Q04 Reset

### Initializing (performing a factory reset)

This will restore all of the earbud settings to their factory defaults. The information for devices registered (paired) will be deleted.

#### 1 Remove earbuds (L) and (R) from the charging case.

The indicators light up blue for one second.

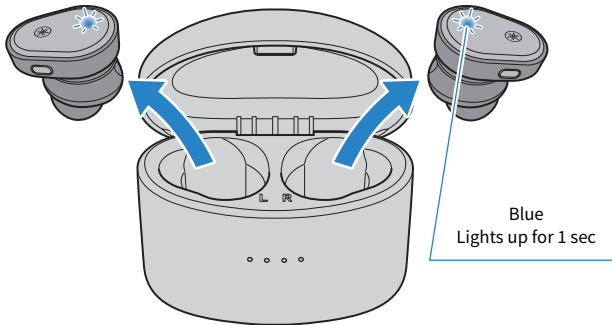

#### 2 Hold down the function key and the + (plus) key for about seven seconds to turn the power off.

Make sure that the indicator lights up as shown below.

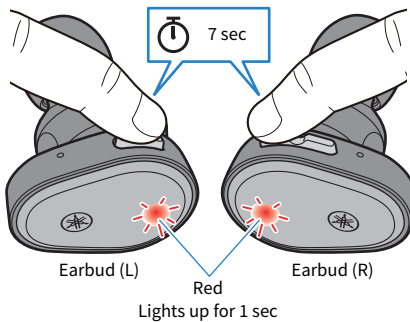

**3 After the power turns off, hold down the function key and the + (plus) key for 10 seconds.**

Make sure that the indicator lights up as shown below.

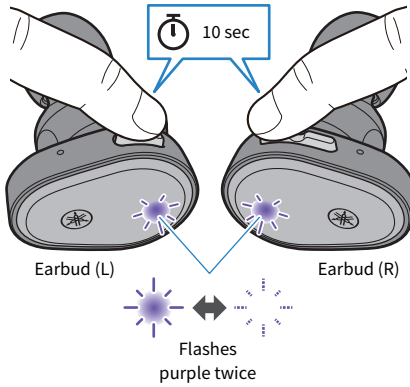

**4 Place earbuds (L) and (R) in the charging case.**

The earbuds are now initialized (factory reset).

**Related links**

"Pairing for the First Time" (p.17)

## Updating the firmware

Update the firmware on this product with the Headphone Control app.

The firmware on this product can be updated to add new functionality, rectify product issues and so on. For more details on the contents of updates, see the product information page on the Yamaha website.

### NOTICE

- For stable data communication between this product and your Bluetooth device, update the firmware in a place where the signal is good. Do not do the following while the firmware is being updated.
  - Placing the earbuds in the charging case
  - Turning the power of this product off
  - Closing the Headphone Control app, or using another app
  - Turning your smartphone off
  - Canceling the connection between your smartphone and this product

**1 On the main screen of the Headphone Control app, open the menu.**

**2 Tap “Check for firmware update”.**

If new firmware has been released, you will see instructions on how to perform the update. Install the firmware by following the instructions on the screen.

### Related links

- “About the “Headphone Control” app” (p.28)
- “App settings” (p.29)

## List of support centers

If the trouble still cannot be solved, please contact us for product support as shown below.

### **For customers within Japan**

- Please contact the store where you purchased this product, or the Product Support Center as listed in the “Quick Start Guide” included with this product.

### **For customers outside of Japan**

- Please contact your nearest authorized Yamaha dealer or service center.  
<https://manual.yamaha.com/av/support/>

# Appendix

## List of operations

The main operations of this product are as shown below.

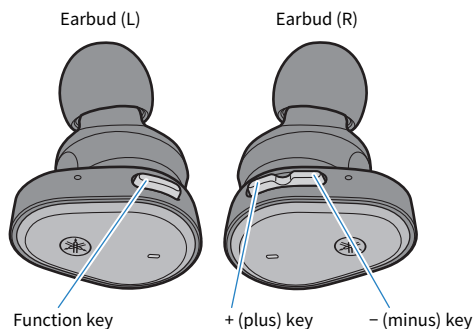

### Power

- Power on  
Remove from the charging case
- Power off  
Function key, + (plus) key (hold down for seven seconds)

### Volume

- Volume up  
+ (plus) key
- Volume down  
- (minus) key

### Audio playback

- Pause/play  
Function key
- Skip to the next song  
+ (plus) key (press quickly twice)
- Go back to the beginning of the song, or skip to the previous song  
- (minus) key (press quickly twice)  
The operation may differ, depending on the Bluetooth device or app you use.

### Selecting the modes

- Switch AMBIENT SOUND/ON/OFF  
Function key (press quickly, two times in a row)

## Phone calls

- Receive a phone call  
Function key
- End a phone call  
Function key (hold down during a call for at least one second)
- Ignore a call  
Function key (hold down when a call is coming in for at least one second)

## Other functions

- Start pairing  
Hold down the function key and + (plus) key with the power turned on (hold both down for about three seconds and then release)
- Start voice assistant  
– (minus) key (hold down for about one second)
- End voice assistant (Siri only)  
– (minus) key (hold down for about one second)

## List of indicator displays and audio messages

The indicator displays and audio messages on this product are shown below.

### Earbud indicator display

- Power on  
Lights up for one second (blue) and turns off
- Standby mode for pairing with Bluetooth device  
Flashes (between red and blue alternately; only the primary earbud)
- Searching for paired Bluetooth device  
Not lit
- Finished connecting to Bluetooth device  
Lights up (blue, for approx. 10 sec) and turns off
- Power off  
Lights up for one second (red) and then turns off (when using the button on the earbuds to turn the power off)
- Earbuds (L) and (R) are connecting  
Flashes (blue)
- Connection with earbud (L) and earbud (R) complete  
Lights up for five seconds (purple) and then turns off

### Indicator display when charging

- Charging  
Lights up (red)
- Charging completed  
Not lit

### Charging case indicator display

When the charging case is not connected to a power source

- For five seconds right after placing the earbuds in the charging case  
Shows the remaining battery power of the charging case and turns off

When the charging case is connected to a power source

- Shows the remaining battery power of the charging case

## Audio messages

- Battery High  
Plenty of battery charge remaining
- Battery Medium  
Moderate battery charge remaining
- Battery Low  
Small amount of battery charge remaining
- Power Off  
Power off
- Pairing  
Start pairing (device registration)
- Pairing Successful  
Pairing successful/finished connecting
- Pairing Failed  
Pairing unsuccessful
- Connected  
Finished connecting to Bluetooth device
- Disconnected  
Disconnected from Bluetooth device
- Link Lost  
The link to the Bluetooth device has been severed

## Related links

- “Charging the earbuds” (p.10)
- “Charging the charging case” (p.12)
- “Turning on the power” (p.14)
- “Turning off the power” (p.15)
- “Remaining Battery Power” (p.16)
- “Pairing for the First Time” (p.17)
- “Pairing with a Different Device” (p.19)
- “Connecting to a Device Already Paired” (p.21)
- “Making ambient sounds easier to hear (AMBIENT SOUND)” (p.25)

## Specifications

The specifications of this product are as shown below.

- Driver type  
Dynamic
- Driver unit  
7 mm
- Frequency range  
20–20,000 Hz
- Bluetooth version  
5.2
- Supported profiles  
A2DP, AVRCP, HFP, HSP
- Supported codecs  
SBC, AAC, Qualcomm® aptX™ Adaptive
- Supported content protection (Japan only)  
SCMS-T
- RF output power  
Class 1
- Maximum communication range  
10 m (without obstructions)
- Maximum number of pairable devices  
3

### Microphone for phone calls

- Driver type  
MEMS
- Directivity characteristics  
Overall directivity
- Frequency range  
100–10,000 Hz

### Rechargeable battery

- Internal rechargeable battery  
Lithium-ion battery
- Charging time (to full capacity)  
Earbuds: approx. 1.5 hours  
Charging case: approx. 2.5 hours
- Continuous playback time  
Approximately 8.5 hours  
Number of earbud charging cycles available with charging case (when charging case is fully charged)  
Approx. 3 times
- Temperature range for usage (when charging)  
5–40°C  
Charge this product within the listed temperature range.

## **General**

- Waterproof rating  
IPX 5 (earbuds)
- Weight  
6.5 g (per earbud)

\*The explanations in this User Guide are written according to the latest specifications as of the date of publication. For the latest version of the User Guide, refer to the Yamaha website.

## Trademarks

The trademarks used in this guide are as follows.

The Bluetooth® word mark and logos are registered trademarks owned by Bluetooth SIG, Inc. and any use of such marks by Yamaha Corporation is under license. Other trademarks and trade names are those of their respective owners.

Qualcomm aptX and Qualcomm TrueWireless are products of Qualcomm Technologies, Inc. and/or its subsidiaries.

Qualcomm and Qualcomm TrueWireless are trademarks of Qualcomm Incorporated, registered in the United States and other countries.

### **Android and Google Play**

Google, Android and Google Play are trademarks of Google LLC.

### **App Store**

App Store is a service mark of Apple Inc., registered in the U.S. and other countries.

### **Siri**

Siri is a trademark of Apple Inc., registered in the U.S. and other countries and regions.

Yamaha Global Site  
<https://www.yamaha.com/>

Yamaha Downloads  
<https://download.yamaha.com/>

© 2022 Yamaha Corporation

Published 06/2022 AM-B0

AV20-0151